



US00D451332B1

(12) **United States Design Patent**
Busalt

(10) **Patent No.:** **US D451,332 S**

(45) **Date of Patent:** **** Dec. 4, 2001**

(54) **COOKTOP WITH SENSOR ELEMENT**
(75) Inventor: **Gerhard Busalt**, Traunreut (DE)
(73) Assignee: **BSH Bosch und Siemens Hausgeraete GmbH**, Munich (DE)
(**) Term: **14 Years**

5,528,015 * 6/1996 Von Blanquet et al. 219/453
5,549,100 * 8/1996 Heisner et al. 126/39 J
5,854,520 * 12/1998 Buck et al. 307/141
6,050,176 * 4/2000 Schultheis et al. 99/339
6,103,338 * 8/2000 Gille et al. 428/121
6,111,229 * 8/2000 Schultheis 219/452.11
6,198,080 * 3/2001 Rice et al. 219/506

* cited by examiner

(21) Appl. No.: **29/136,666**

(22) Filed: **Feb. 5, 2001**

(30) **Foreign Application Priority Data**

Aug. 4, 2000 (DE) 4 00 07 531

(51) **LOC (7) Cl.** **07-02**

(52) **U.S. Cl.** **D7/346; D7/340**

(58) **Field of Search** D7/346, 340, 402,
D7/405, 406, 407; 219/445, 445.1, 448.11,
448.12, 448.17, 453.14, 506, 626; 126/214 A;
307/131

(56) **References Cited**

U.S. PATENT DOCUMENTS

D. 349,004 * 7/1994 Ivanovich D7/340
D. 371,272 * 7/1996 Wilsdorf D7/340
5,357,080 * 10/1994 Vetter et al. 219/453

Primary Examiner—Philip S. Hyder

Assistant Examiner—Daniel Bui

(74) *Attorney, Agent, or Firm*—Herbert L. Lerner;
Laurence A. Greenberg; Werner H. Stemer

(57) **CLAIM**

The ornamental design for a cooktop with sensor element, as shown and described.

DESCRIPTION

FIG. 1 is a left side view of the cooktop with sensor element;
FIG. 2 is a plan view thereof;
FIG. 3 is a right side view thereof;
FIG. 4 is a front view thereof;
FIG. 5 is a bottom view thereof;
FIG. 6 is a rear view of FIG. 5; and,
FIG. 7 is a perspective view thereof.

1 Claim, 2 Drawing Sheets

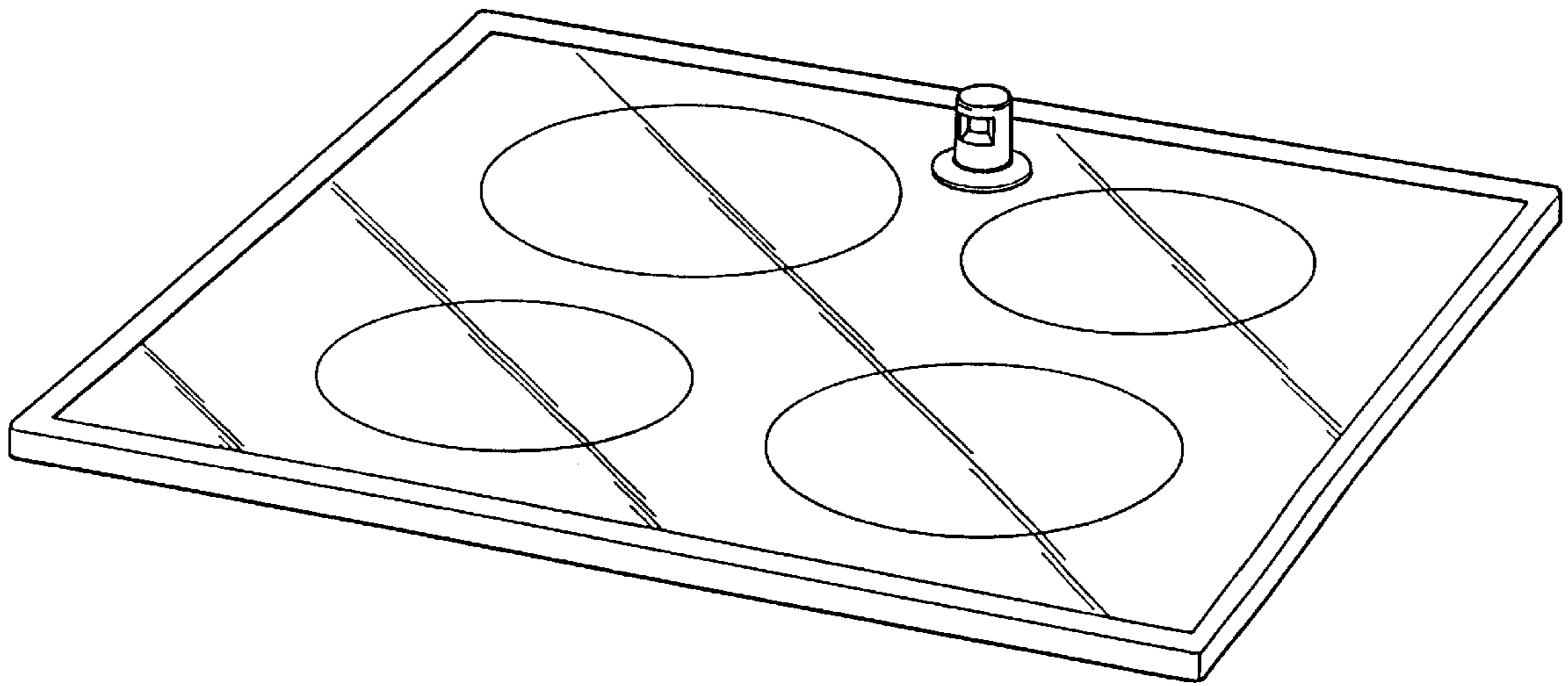

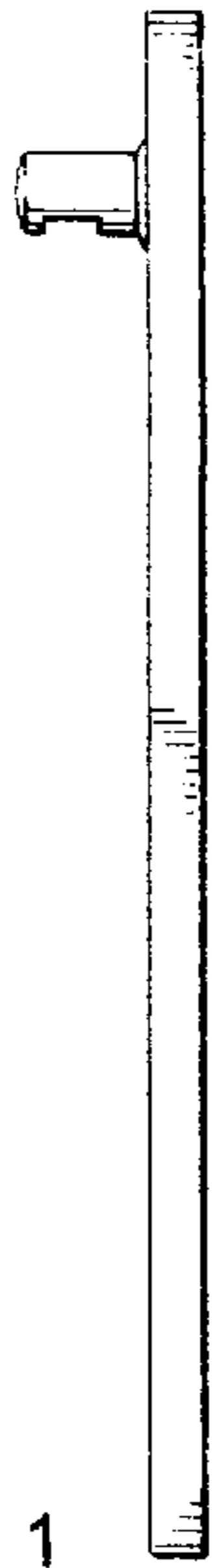

Fig. 1

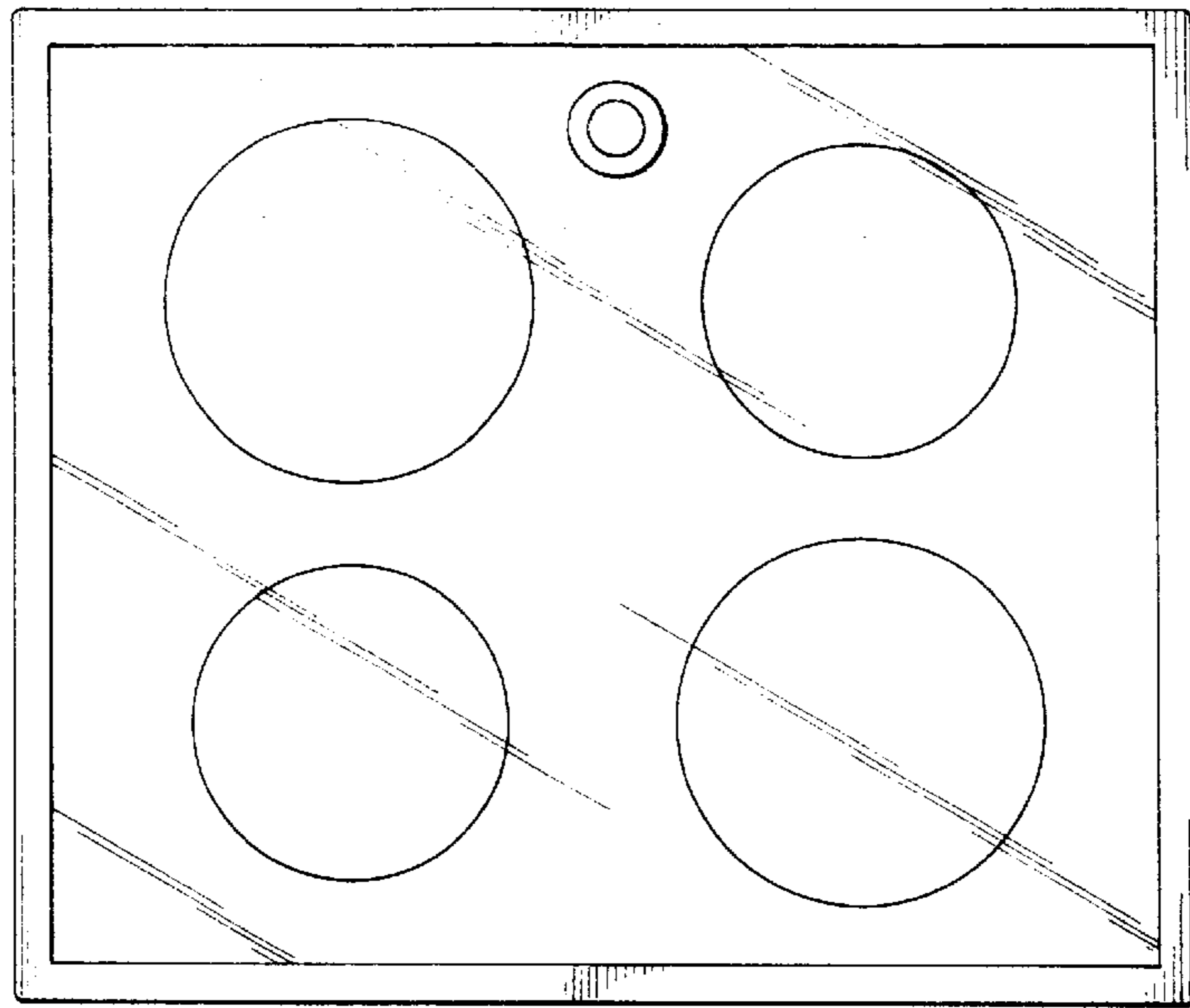

Fig. 2

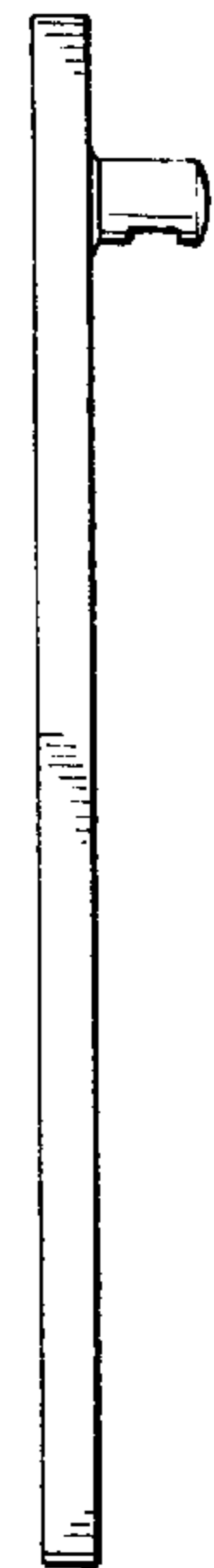

Fig. 3

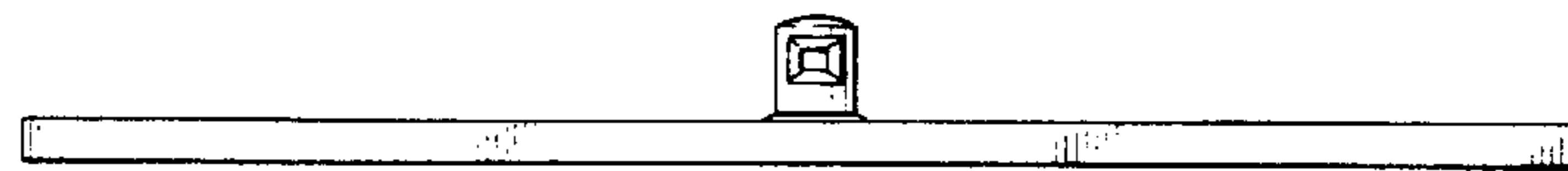

Fig. 4

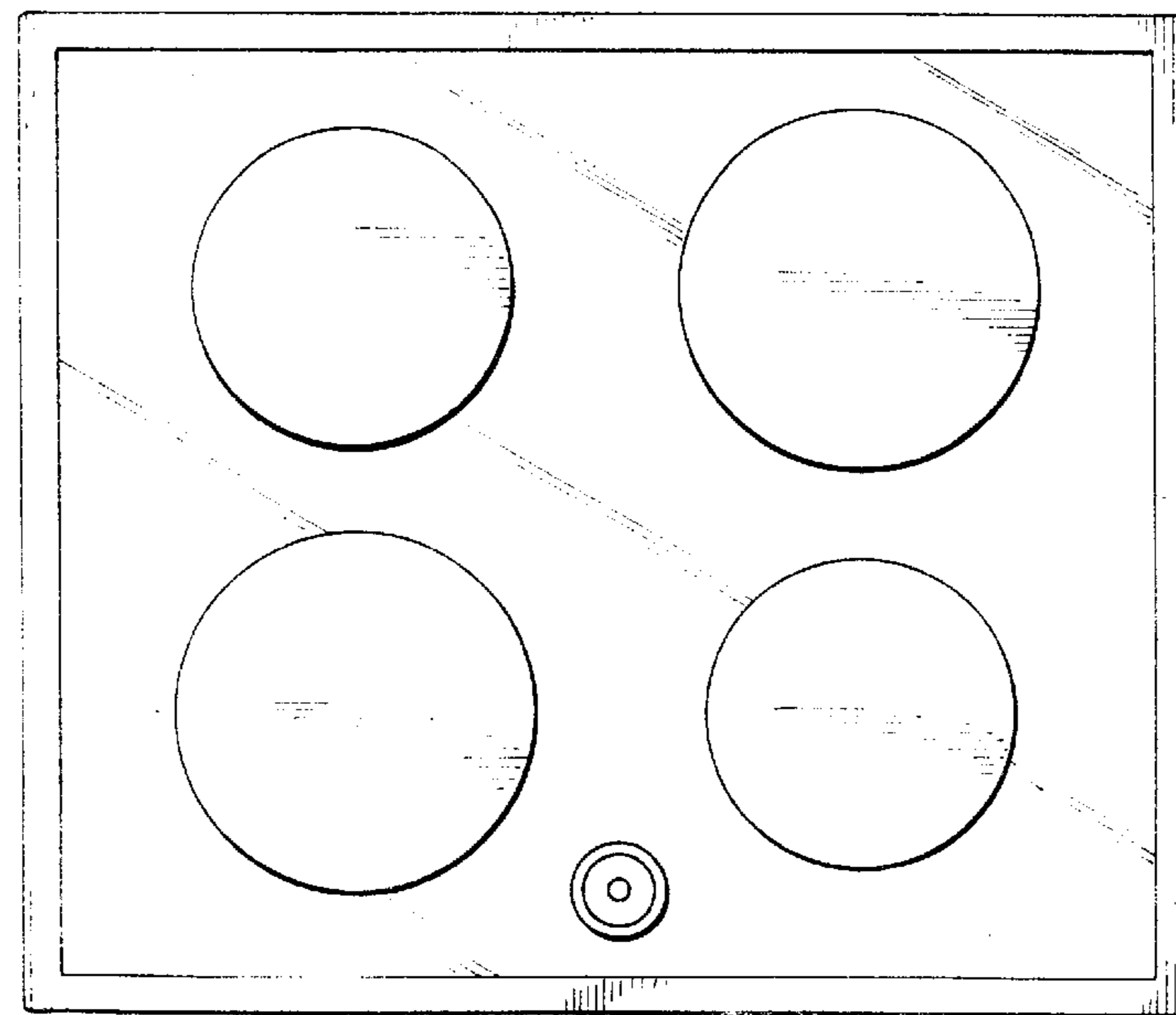

Fig. 5

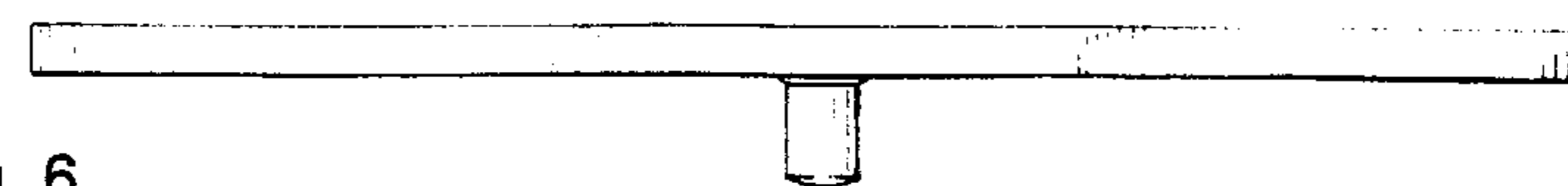

Fig. 6

Fig. 7

