



US00D451320B1

(12) **United States Design Patent**  
**Chi**

(10) **Patent No.:** **US D451,320 S**

(45) **Date of Patent:** **\*\* Dec. 4, 2001**

(54) **ARMREST**

(74) *Attorney, Agent, or Firm*—Rosenberg, Klein & Lee

(76) **Inventor:** **Ching-Hui Chi**, No. 24-2, Hsi Wei Street, San Chung City, Taipei Hsien (TW)

(57) **CLAIM**

The ornamental design for an armrest, as shown and described.

(\*\*) **Term:** **14 Years**

**DESCRIPTION**

(21) **Appl. No.:** **29/135,005**

FIG. 1 is a perspective view of an armrest showing my new design;

(22) **Filed:** **Jan. 4, 2001**

FIG. 2 is a front elevational view thereof;

(51) **LOC (7) Cl.** ..... **06-06**

FIG. 3 is a rear elevational view thereof;

(52) **U.S. Cl.** ..... **D6/501; D6/366**

FIG. 4 is a left side elevational view thereof;

(58) **Field of Search** ..... D6/334, 335, 364, D6/365, 366, 367, 379, 500, 501, 502; 297/411.2, 411.27, 411.28, 411.29

FIG. 5 is a right side elevational view thereof;

FIG. 6 is a top plan view thereof;

FIG. 7 is a bottom plan view thereof;

FIG. 8 is another left side elevational view thereof;

(56) **References Cited**

FIG. 9 is a cross-sectional view taken along line 9—9 of FIG. 8;

**U.S. PATENT DOCUMENTS**

FIG. 10 is a cross-sectional view taken along line 10—10 of FIG. 8;

D. 383,021 \* 9/1997 Lu ..... D6/500

FIG. 11 is a cross-sectional view taken along line 11—11 of FIG. 8;

D. 403,185 \* 12/1998 Tseng ..... D6/501

FIG. 12 is a cross-sectional view taken along line 12—12 of FIG. 8; and,

D. 417,106 \* 11/1999 Lee ..... D6/501

FIG. 13 is a cross-sectional view taken along line 13—13 of FIG. 8.

D. 425,340 \* 5/2000 Su ..... D6/501

D. 437,499 \* 2/2001 Tseng ..... D6/366

\* cited by examiner

*Primary Examiner*—Gary D. Watson

**1 Claim, 3 Drawing Sheets**

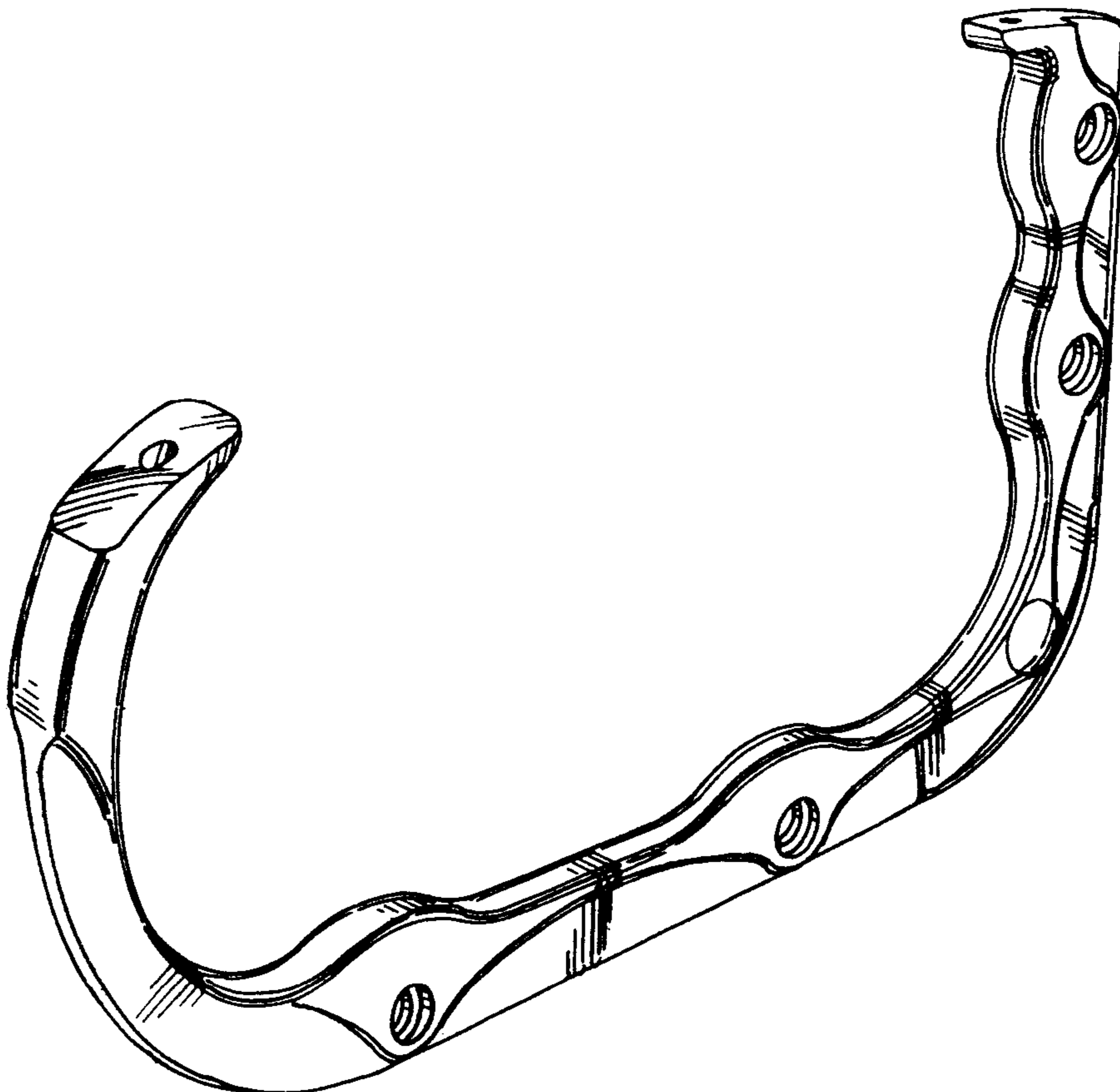

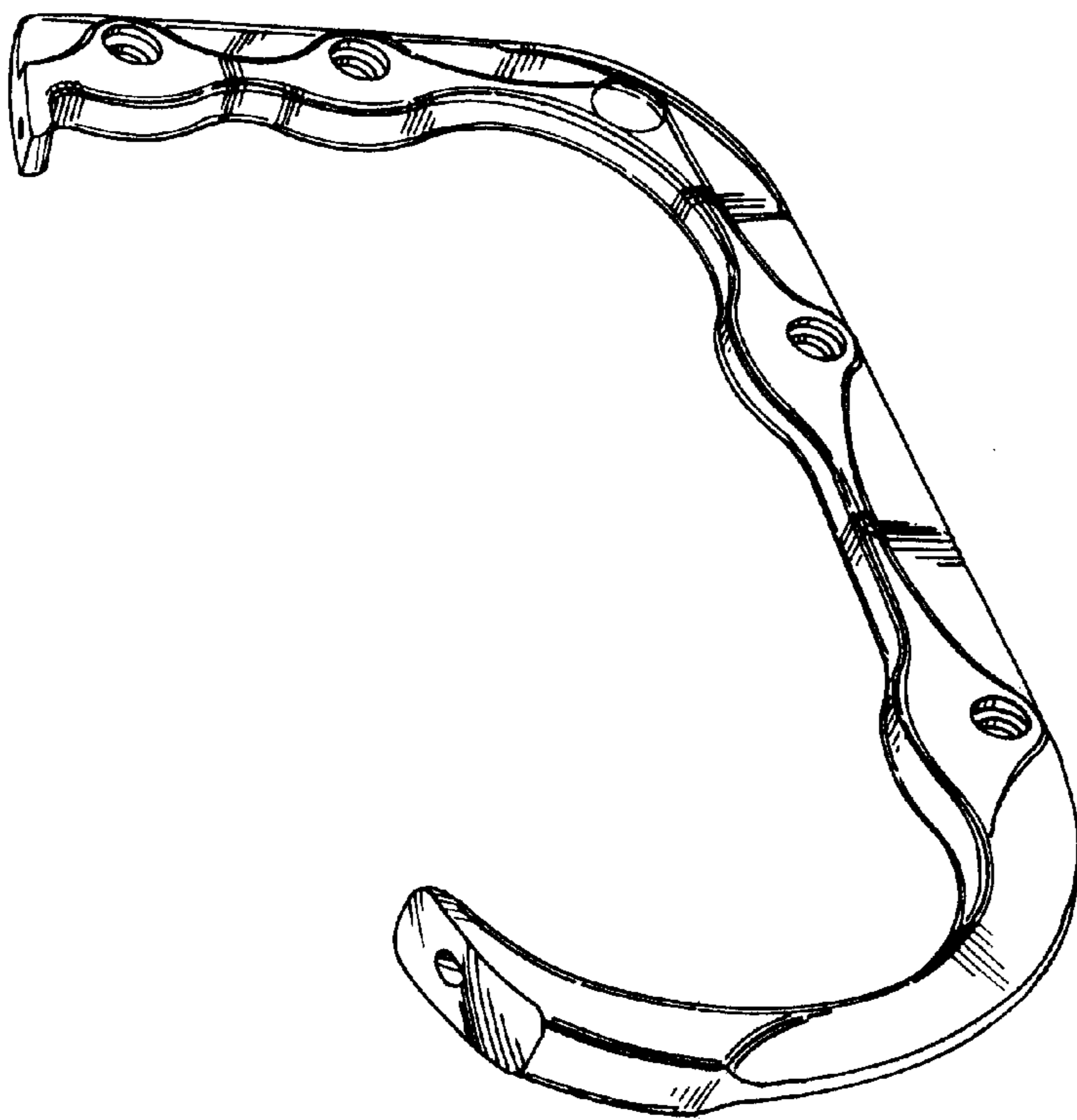

FIG. 1

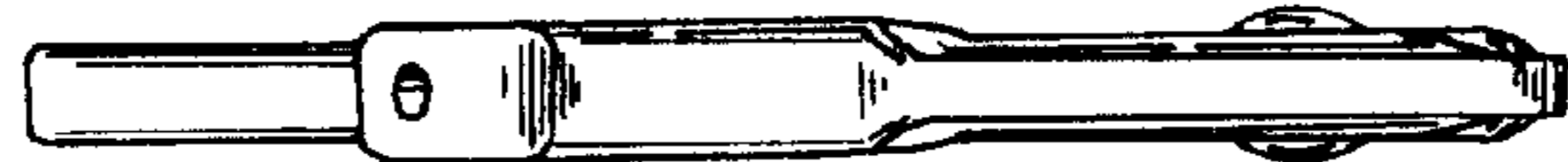

FIG. 2

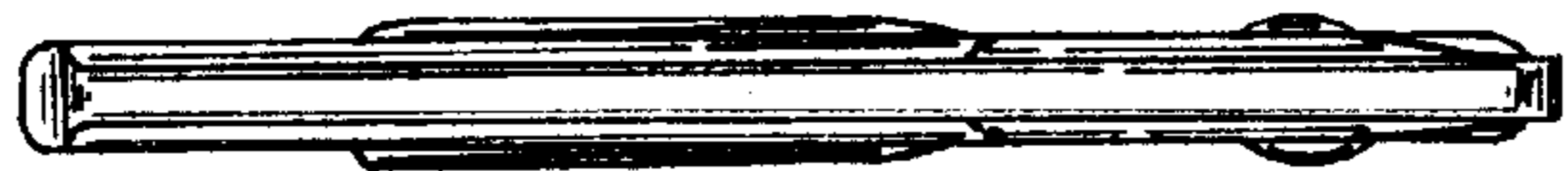

FIG. 3

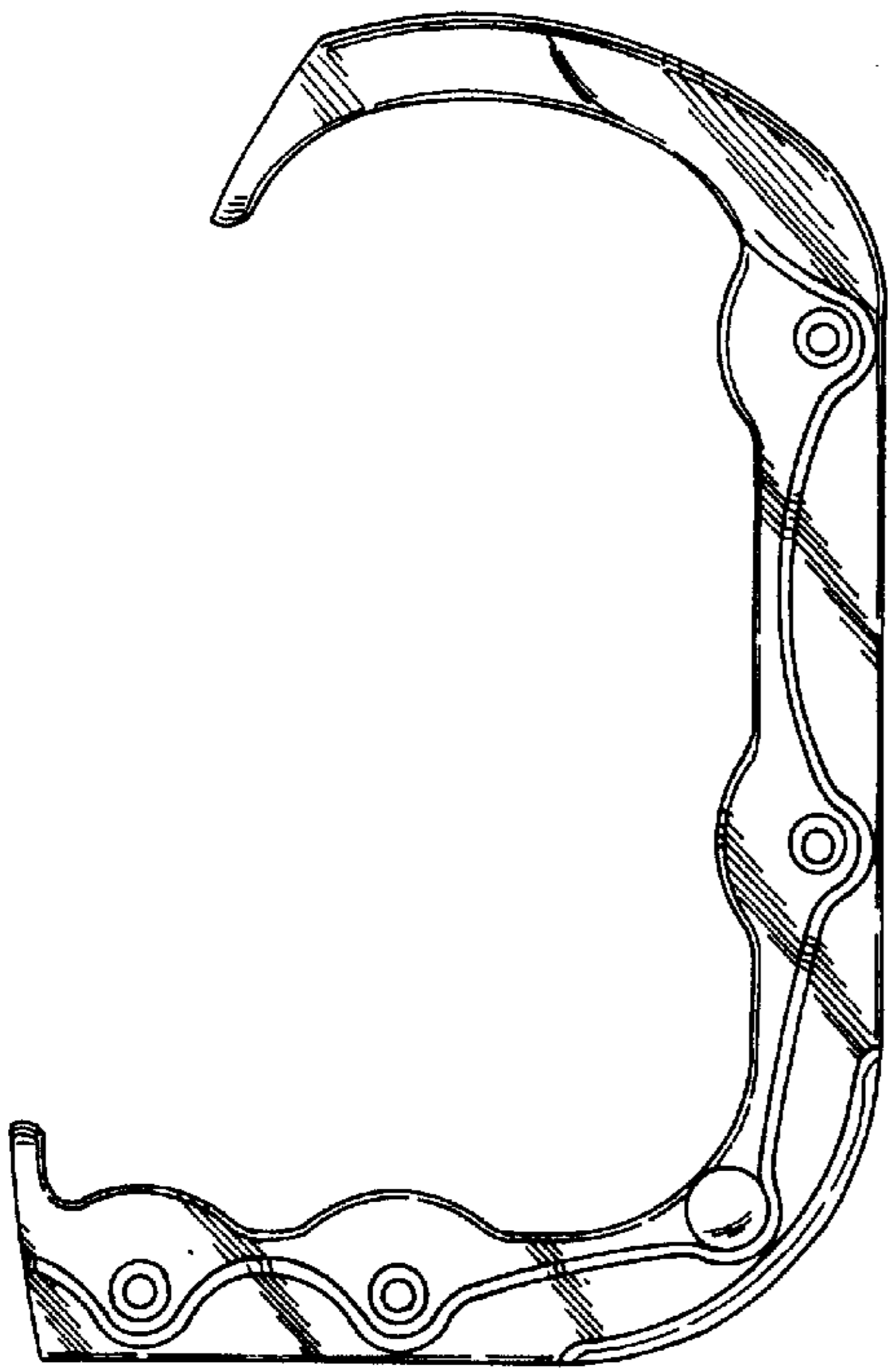

FIG. 4

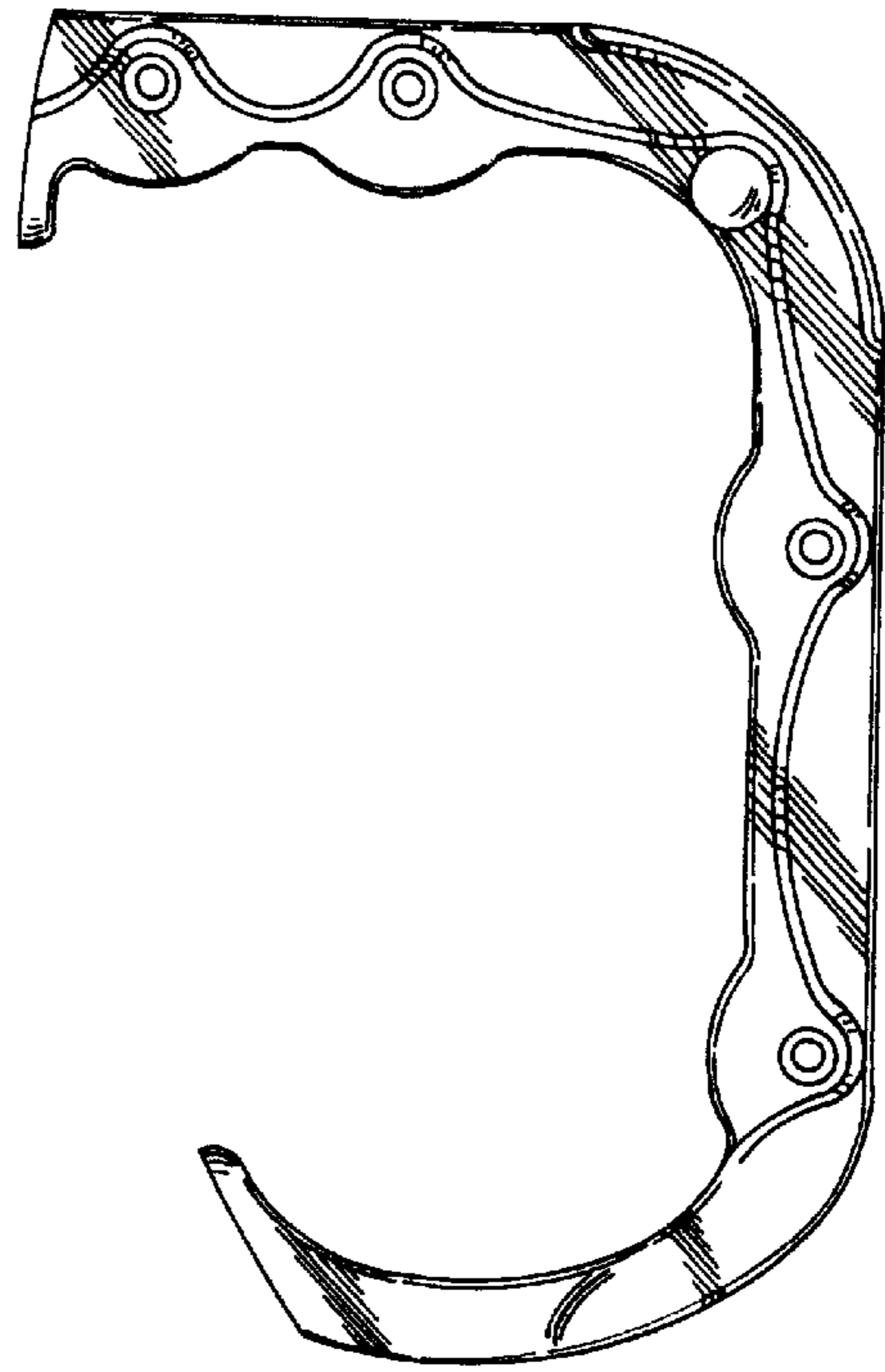

FIG. 5

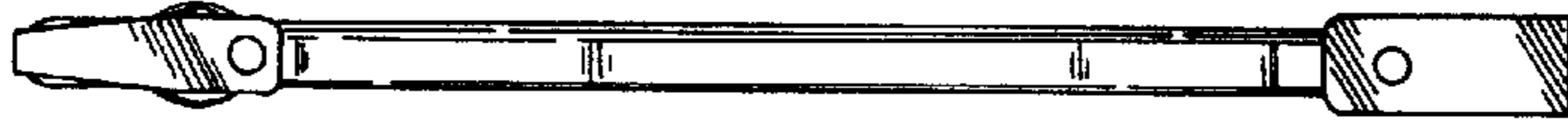

FIG. 6

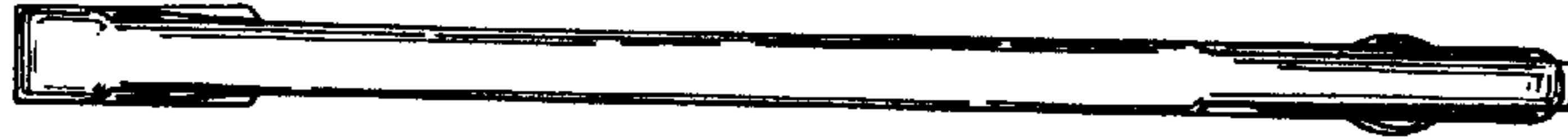

FIG. 7

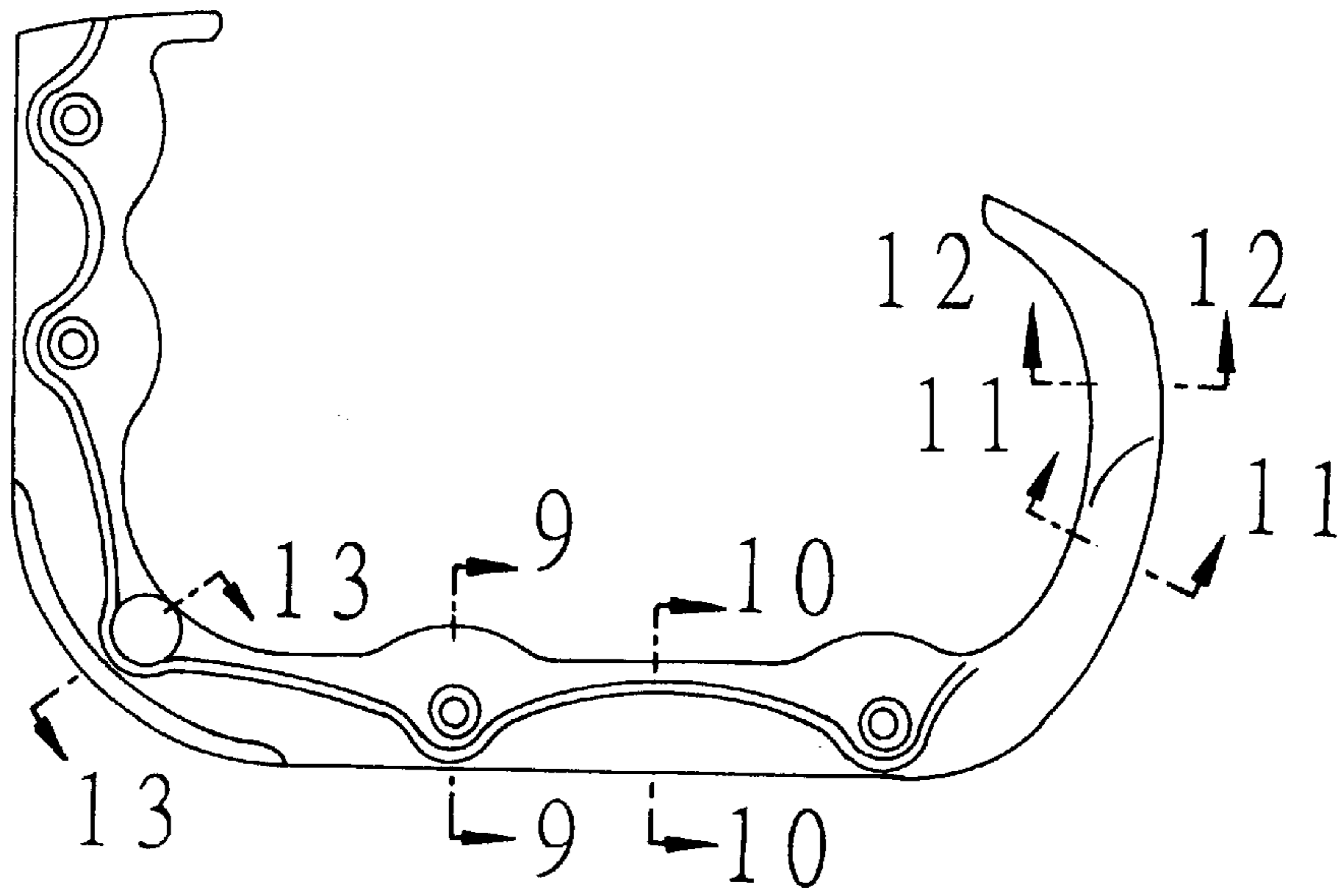

FIG. 8

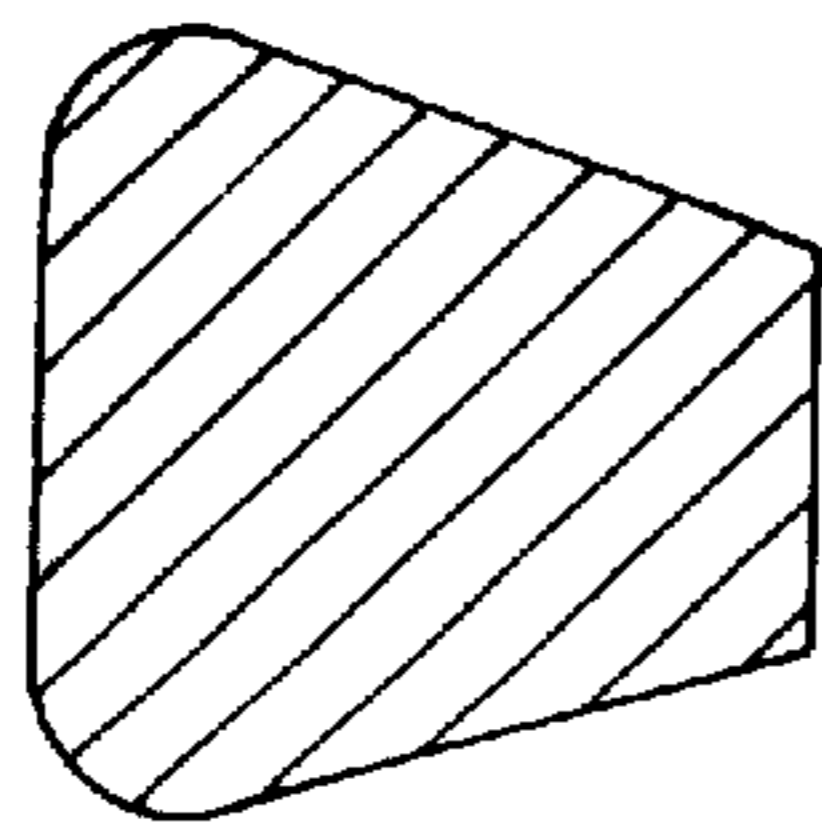

FIG. 11

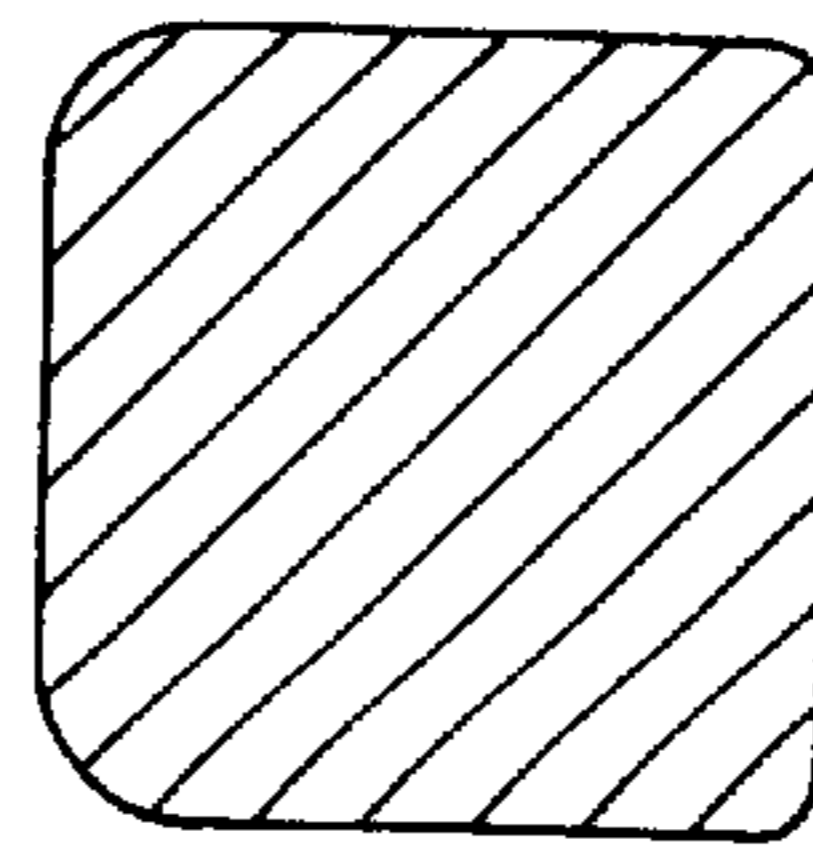

FIG. 12

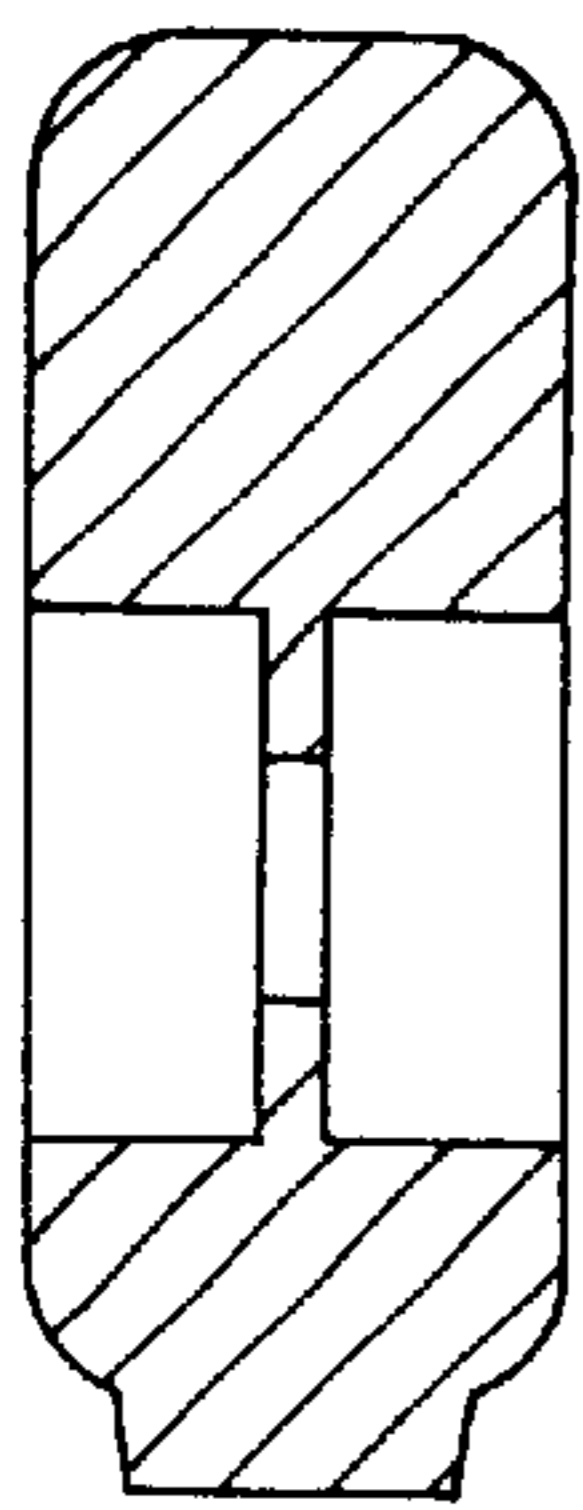

FIG. 9

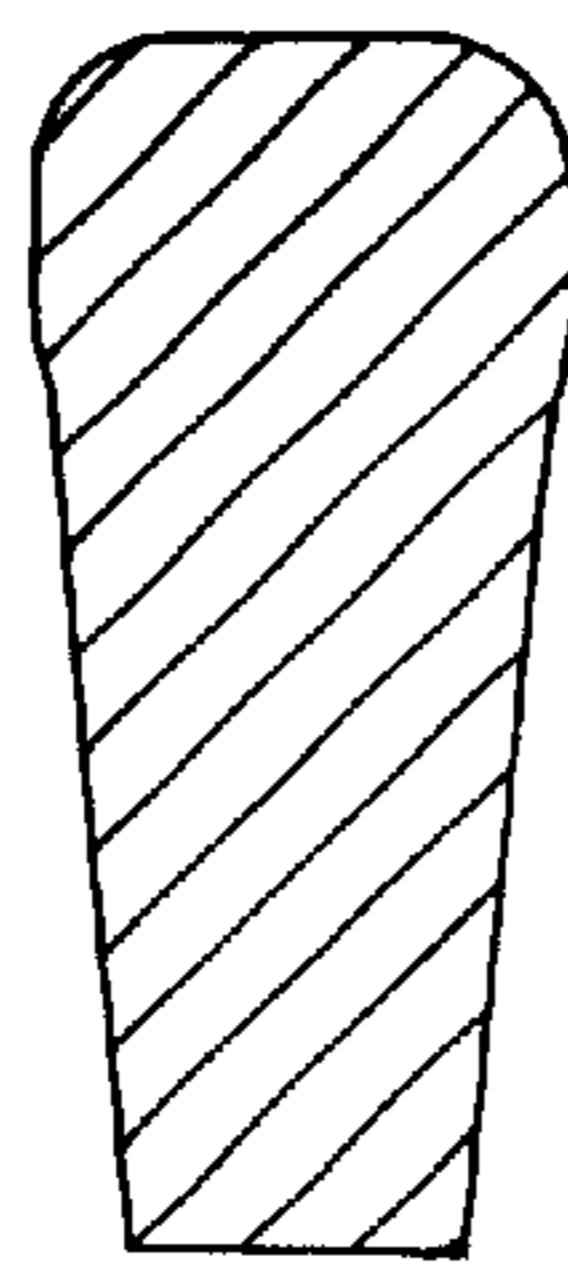

FIG. 10

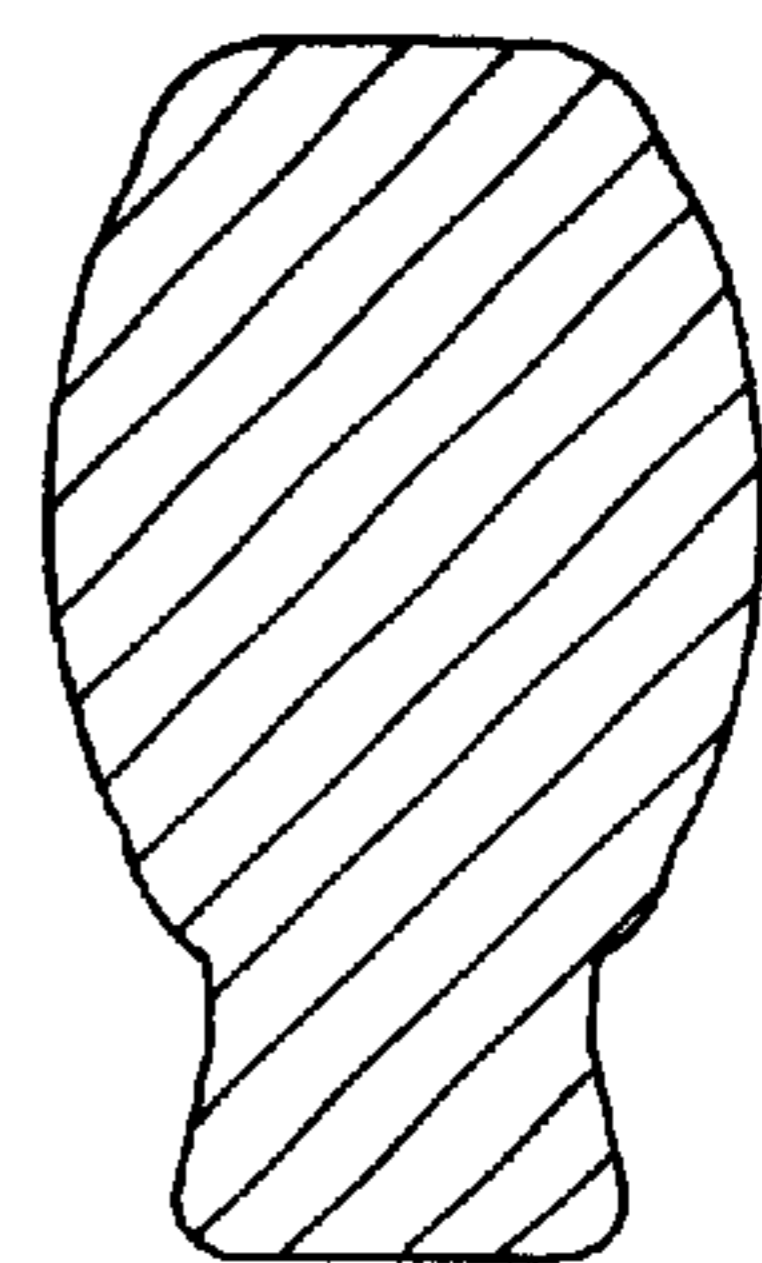

FIG. 13