



US00D451282B1

(12) **United States Design Patent**
Konkle

(10) **Patent No.:** **US D451,282 S**

(45) **Date of Patent:** **** Dec. 4, 2001**

(54) **BUCKLE FOR GOLF BAG**

(75) Inventor: **Stephen A. Konkle**, Kirkland, WA (US)

(73) Assignee: **Catalyst Concepts, Inc.**, Issaquah, WA (US)

(**) Term: **14 Years**

(21) Appl. No.: **29/127,409**

(22) Filed: **Aug. 4, 2000**

(51) **LOC (7) Cl.** **03-01**

(52) **U.S. Cl.** **D3/318; D3/327**

(58) **Field of Search** D3/255, 318, 320,
D3/327; 248/96, 230.8; 224/274, 901.4,
918; 206/315.4

(56) **References Cited**

U.S. PATENT DOCUMENTS

2,040,339	5/1936	Ross .	
2,073,114	3/1937	Martin et al. .	
4,087,068	* 5/1978	Gardner	248/96
5,356,003	10/1994	Gretz et al.	206/315.7
5,361,958	* 11/1994	Fiegel et al.	224/274
5,573,211	* 11/1996	Wu	248/96
5,871,183	* 2/1999	Milluzzi	248/96
6,019,324	* 2/2000	Wu	248/96
6,158,762	* 12/2000	Wong	280/652

* cited by examiner

Primary Examiner—Philip S. Hyder

(74) *Attorney, Agent, or Firm*—Seed IP Law Group PLLC

(57) **CLAIM**

The ornamental design for a buckle for golf bag, as shown and described.

DESCRIPTION

A portion of this disclosure contains material to which a claim for copyright is made. The inventor or his assignee (copyright owner) have no objection to the facsimile reproduction by anyone of the patent document or the patent disclosure, as it appears in the Patent and Trademark Office files or records, but reserve all other copyright rights whatsoever.

FIG. 1 is a front, bottom isometric view of a buckle for golf bag showing my new design in the environment in which it is typically used.

FIG. 2 is a front, bottom isometric view of a buckle for golf bag.

FIG. 3 is a front elevational view thereof.

FIG. 4 is a top plan view thereof.

FIG. 5 is a bottom plan view thereof; and,

FIG. 6 is a right side elevational view thereof; the left side elevational view is a mirror image thereof.

The broken lines in the figures are for illustrative purposes only and form no part of the claimed design.

1 Claim, 6 Drawing Sheets

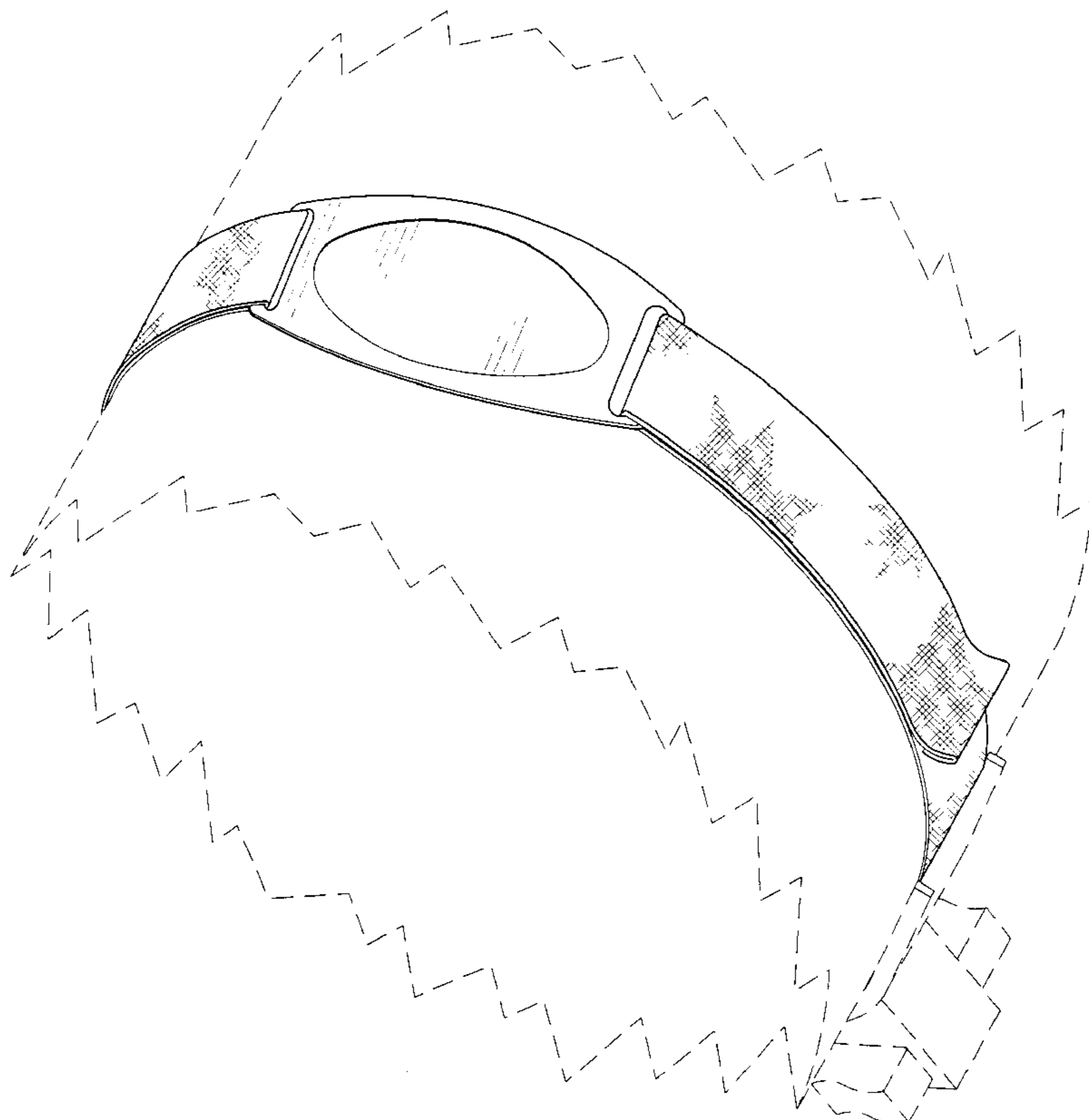

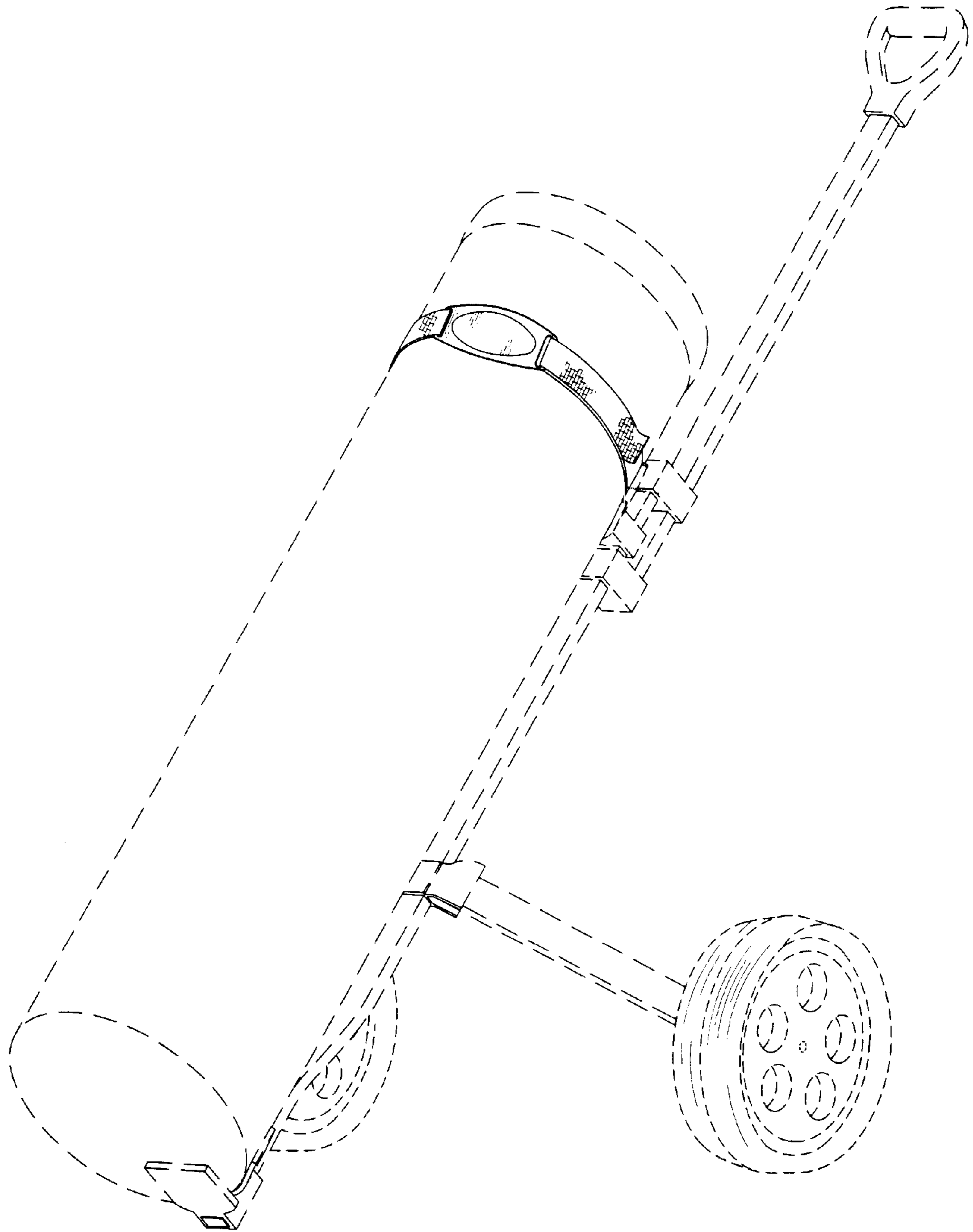

Fig. 1

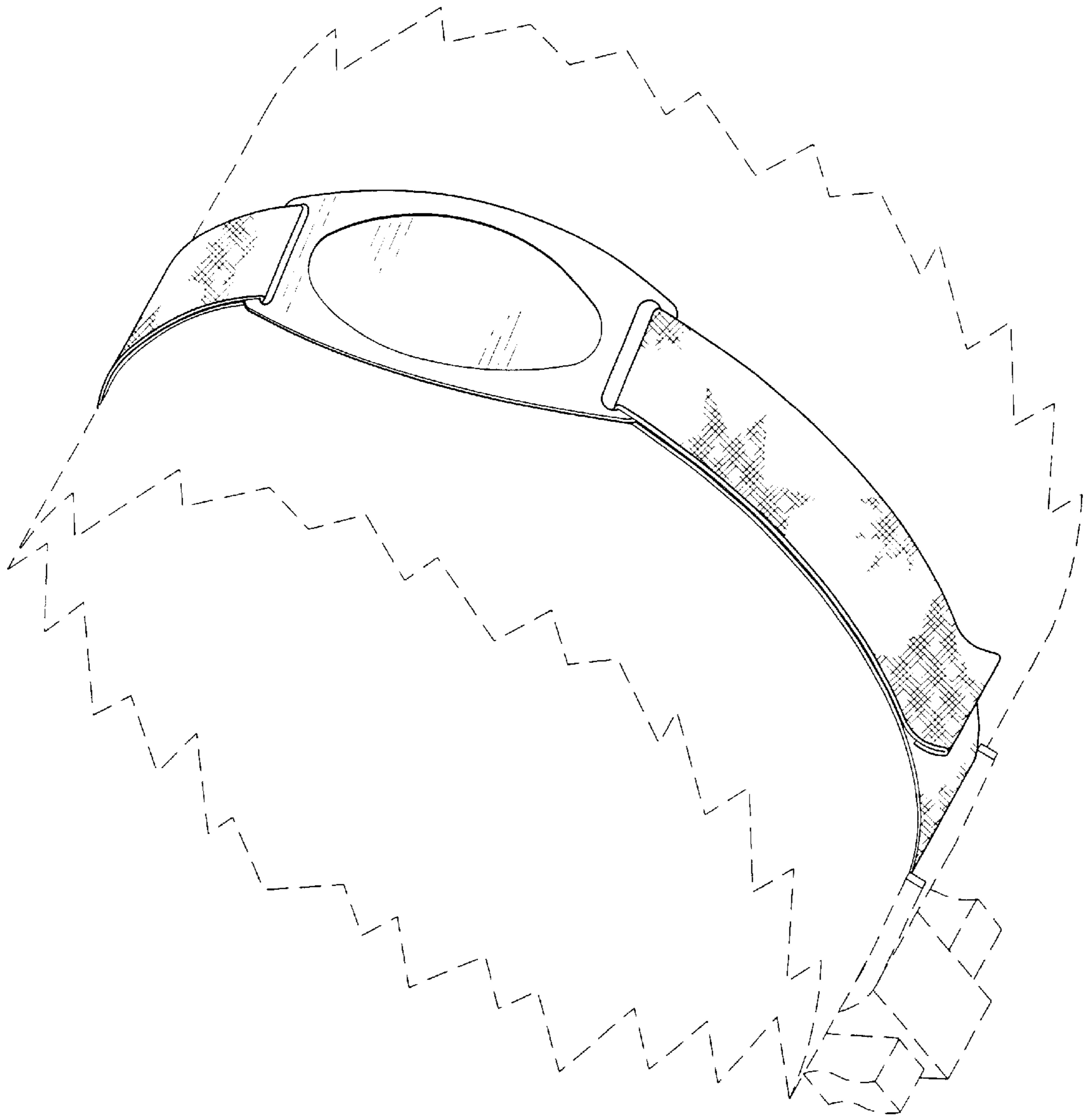

Fig. 2

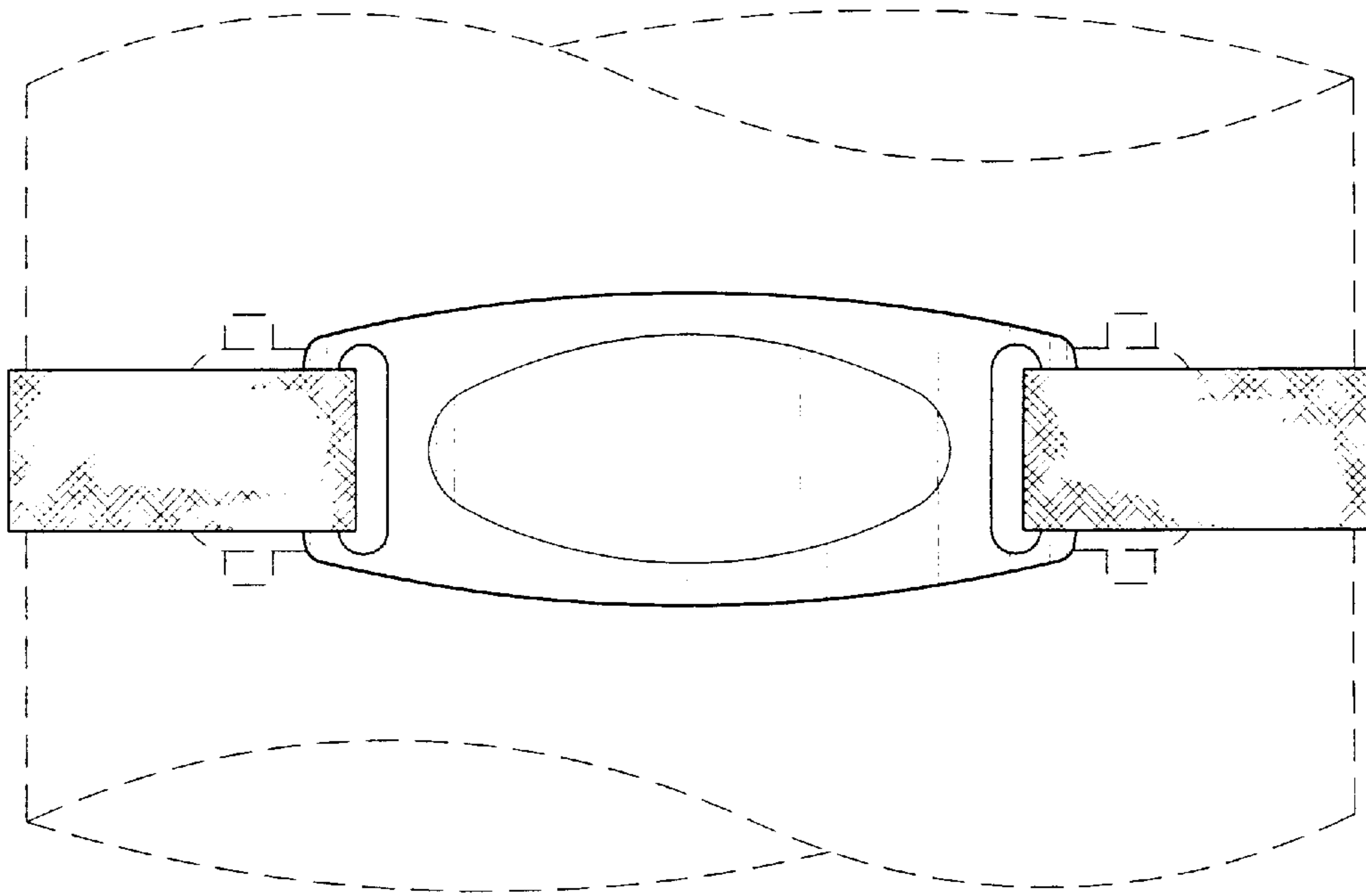

Fig. 3

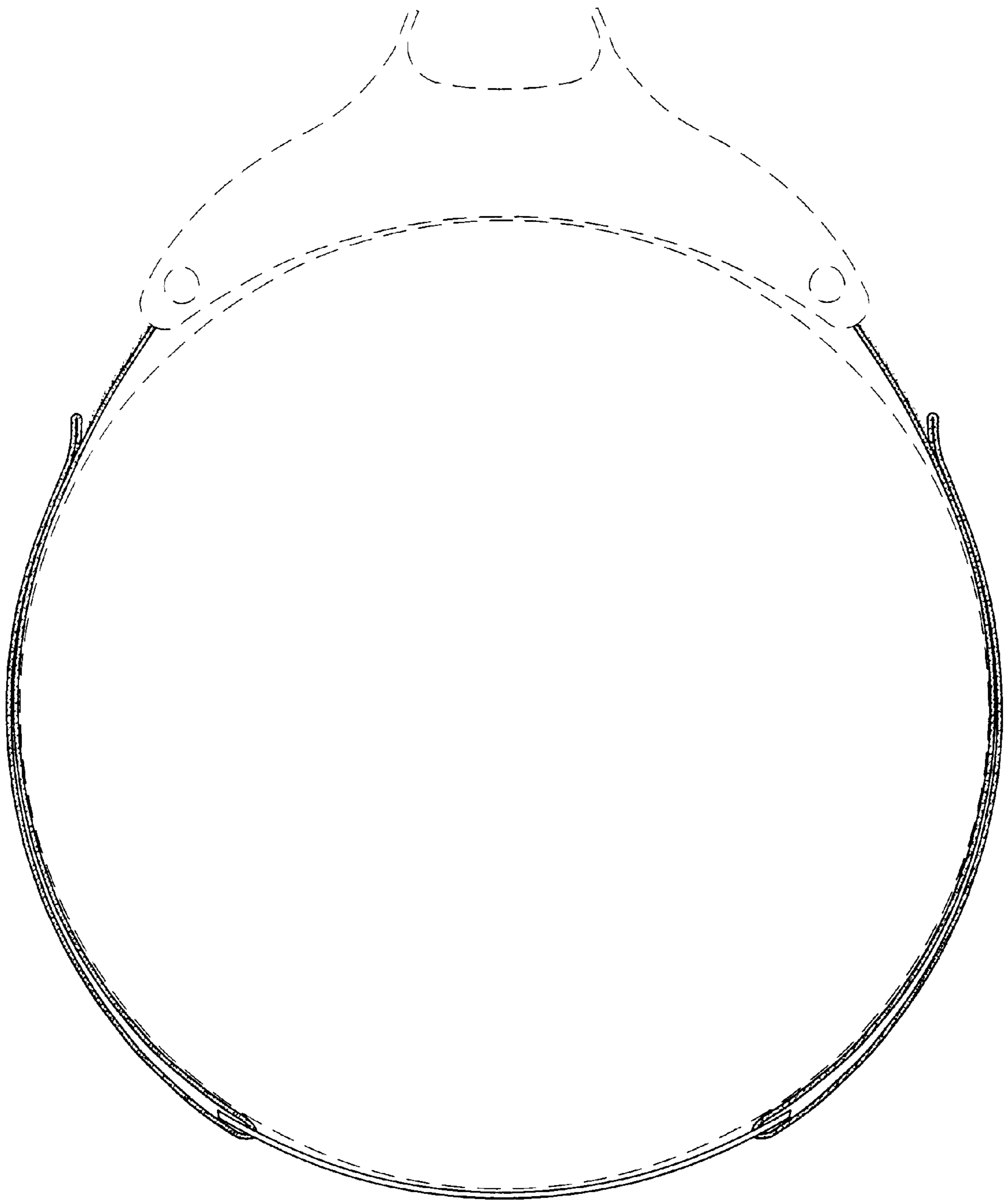

Fig. 4

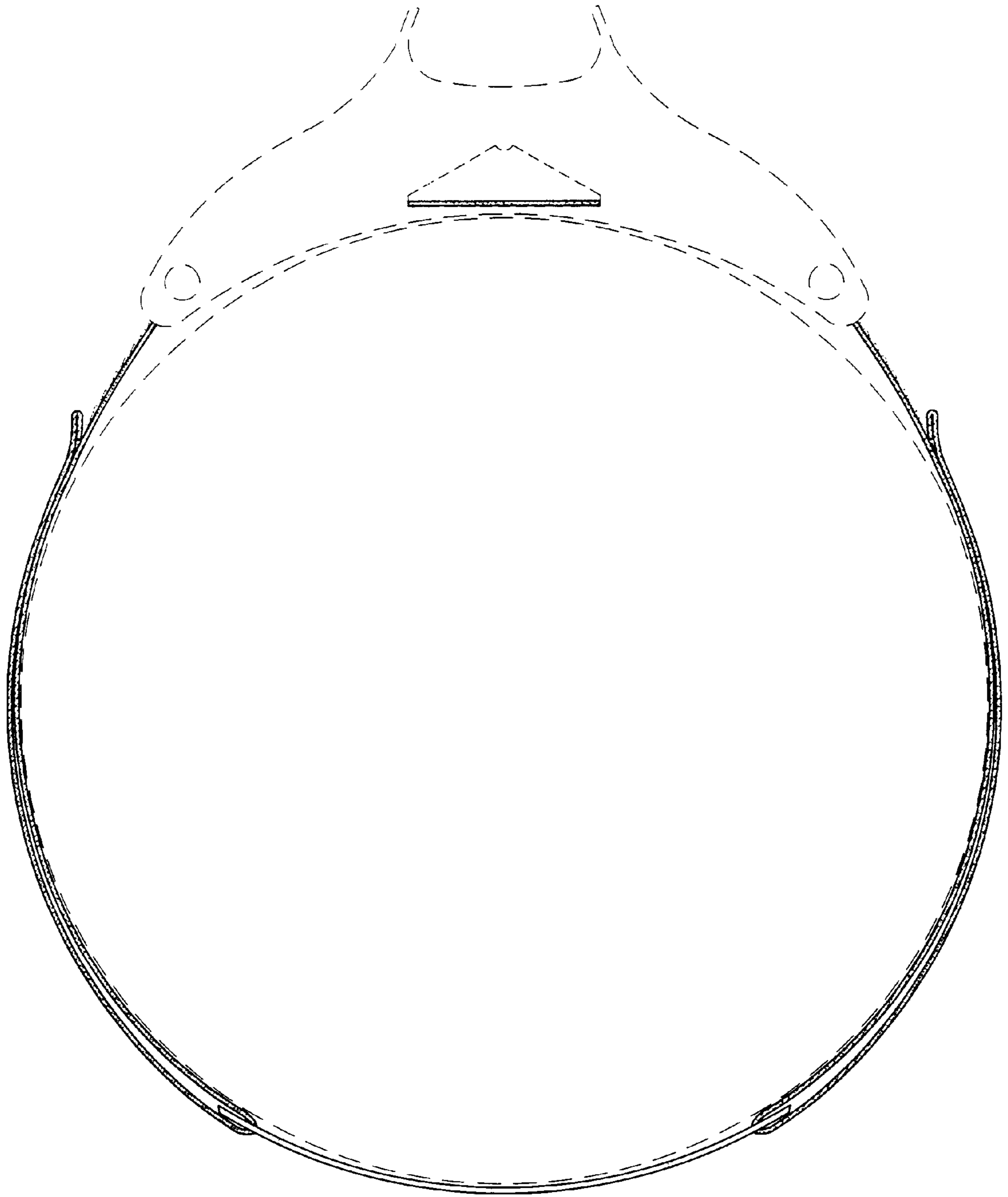

Fig. 5

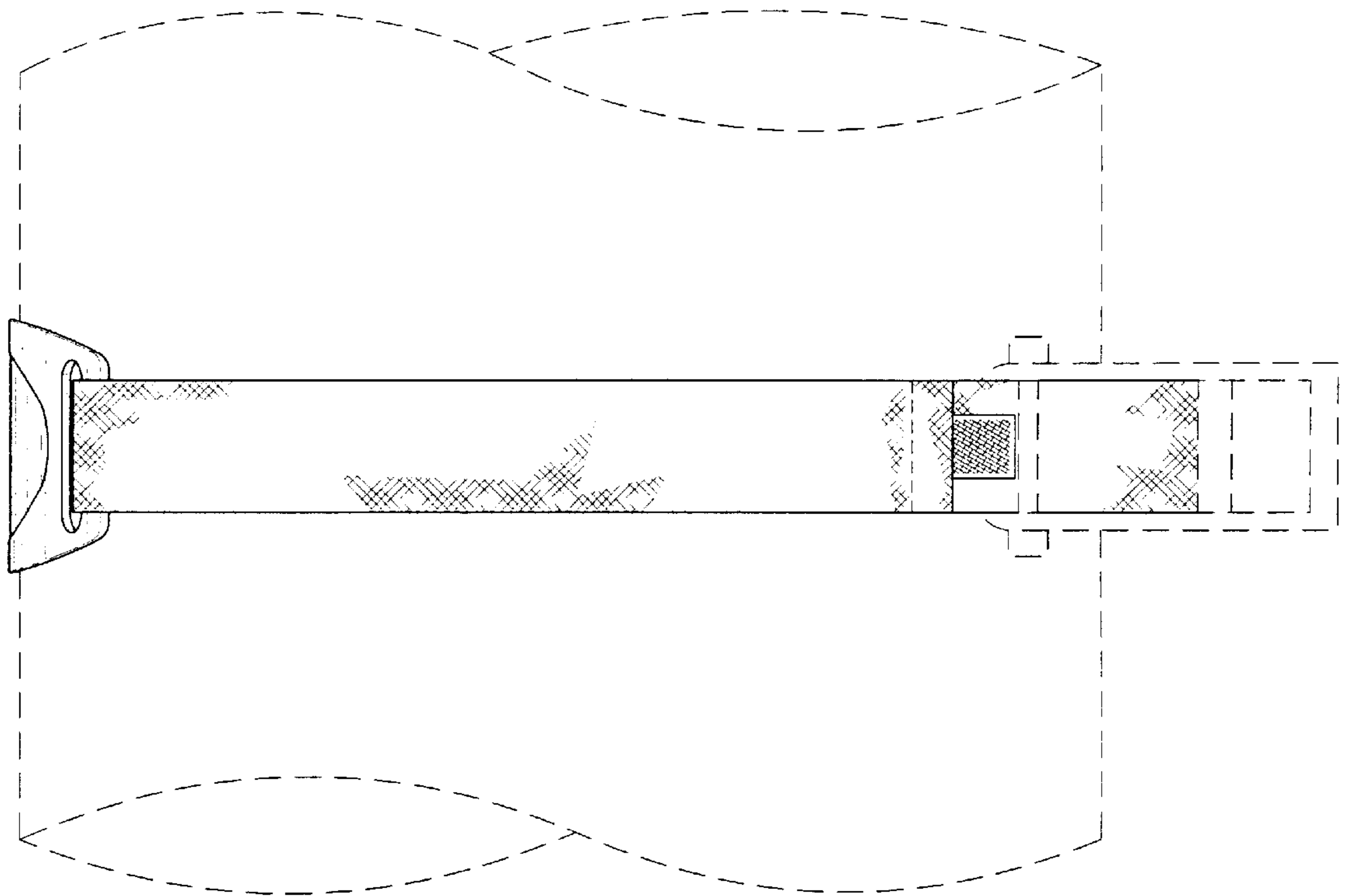

Fig. 6