



US00D451277B1

(12) **United States Design Patent**
Nally

(10) **Patent No.:** **US D451,277 S**

(45) **Date of Patent:** **** Dec. 4, 2001**

(54) **PRODUCT PACKAGING CRATE FOR SPORTING EQUIPMENT**

(75) Inventor: **Michael Nally**, Ridgewood, NJ (US)

(73) Assignee: **Sportcraft, Ltd.**, Mt. Olive, NJ (US)

(**) Term: **14 Years**

(21) Appl. No.: **29/134,985**

(22) Filed: **Jan. 2, 2001**

Related U.S. Application Data

(62) Division of application No. 29/111,017, filed on Sep. 21, 1999, now Pat. No. Des. 441,532.

(51) **LOC (7) Cl.** **03-01**

(52) **U.S. Cl.** **D3/276; D3/272; D3/273**

(58) **Field of Search** **D3/272, 273, 276; D9/420; 217/5, 36, 40; 190/100, 110, 111; 206/315.1**

(56) **References Cited**

U.S. PATENT DOCUMENTS

175,464 3/1876 Hughes 217/40

D. 253,203	10/1979	Hatcher	D3/272
D. 309,104	7/1990	Soloman	D9/420
1,748,825	2/1930	Bell	217/40
1,980,283	4/1934	Miller	217/40
2,121,905	6/1938	Day	217/40
2,179,847 *	11/1939	Fletcher	217/40
4,070,788	1/1978	Richcreek	43/100

* cited by examiner

Primary Examiner—Philip S. Hyder

(74) *Attorney, Agent, or Firm*—Head, Johnson & Kachigian

(57) **CLAIM**

The ornamental design for a product packaging crate for sporting equipment, as shown and described.

DESCRIPTION

FIG. 1 is a left front perspective view of a product packaging crate for sporting equipment;
FIG. 2 is a front view thereof;
FIG. 3 is a rear view thereof;
FIG. 4 is a left side elevational view thereof;
FIG. 5 is a right side elevational view thereof;
FIG. 6 is an overhead view thereof; and,
FIG. 7 is a bottom view thereof.

1 Claim, 4 Drawing Sheets

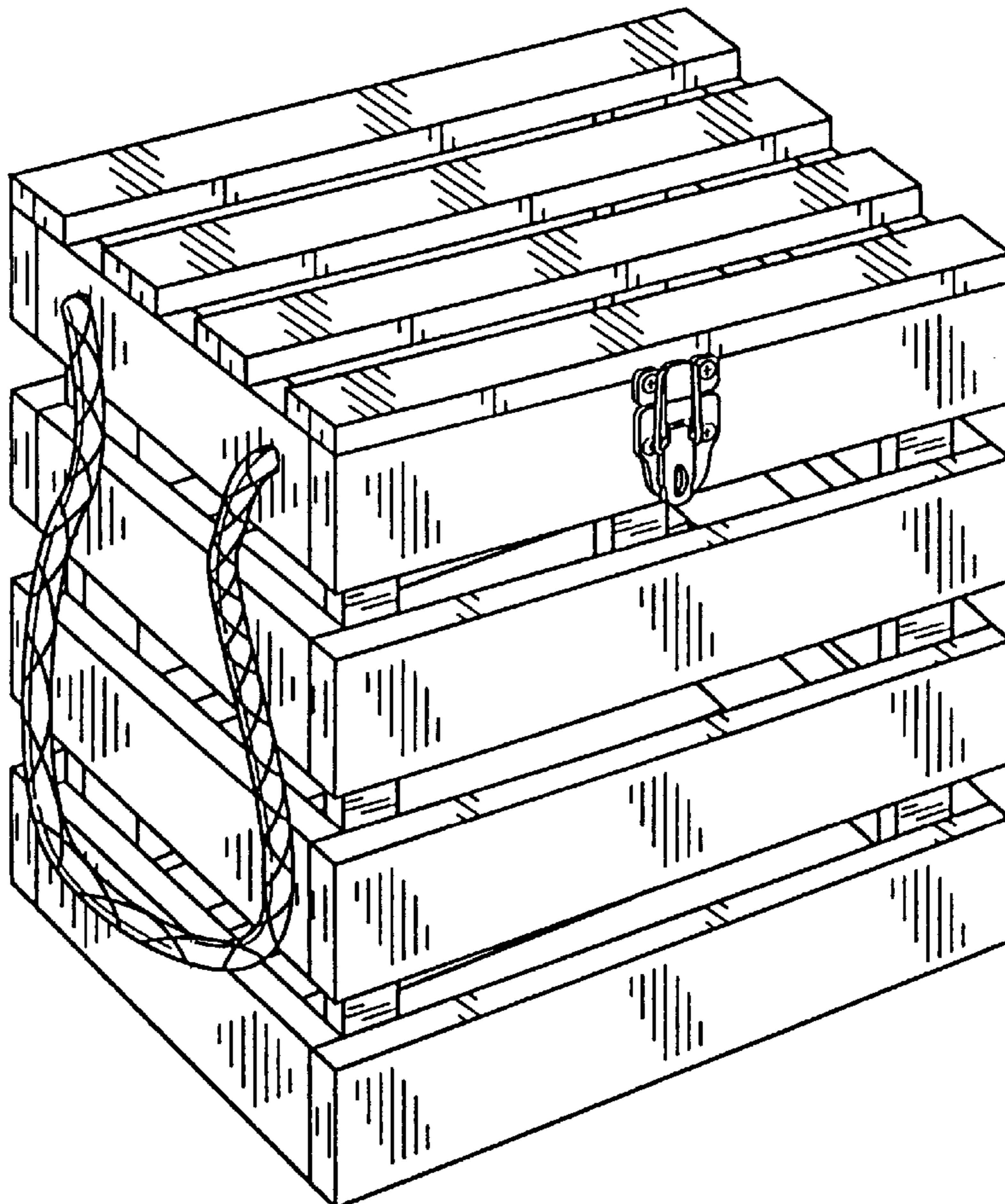

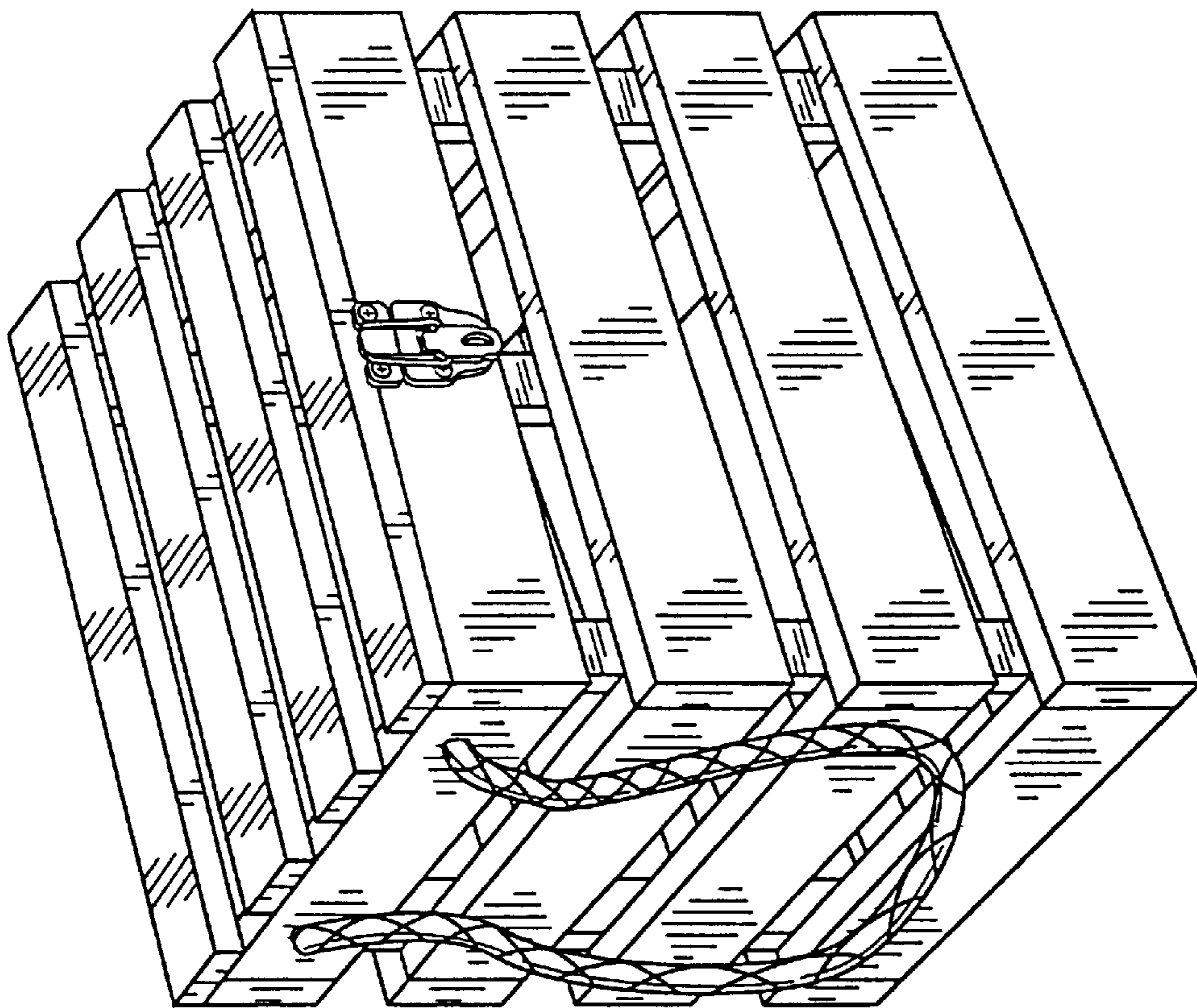

FIG. 1

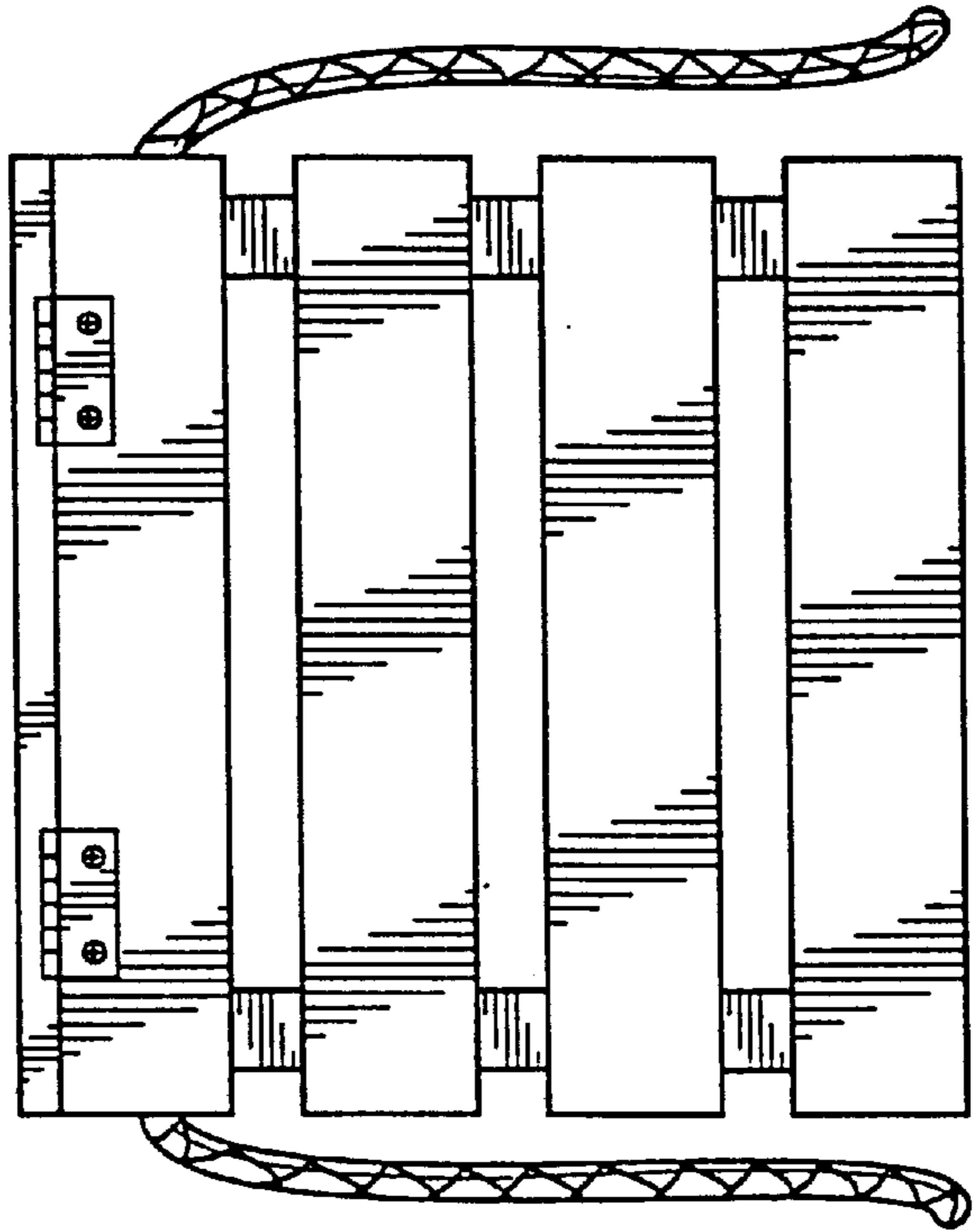

FIG. 3

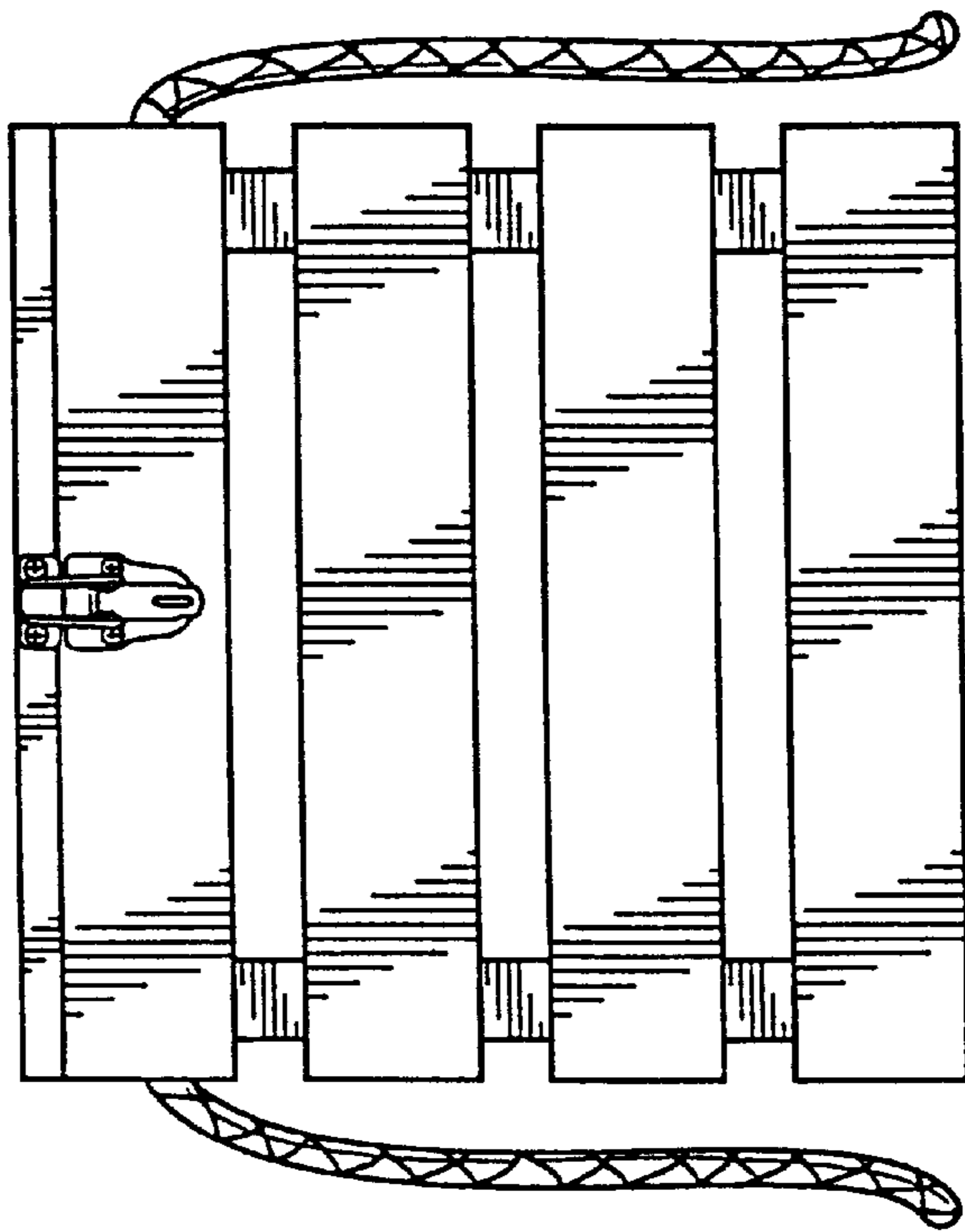

FIG. 2

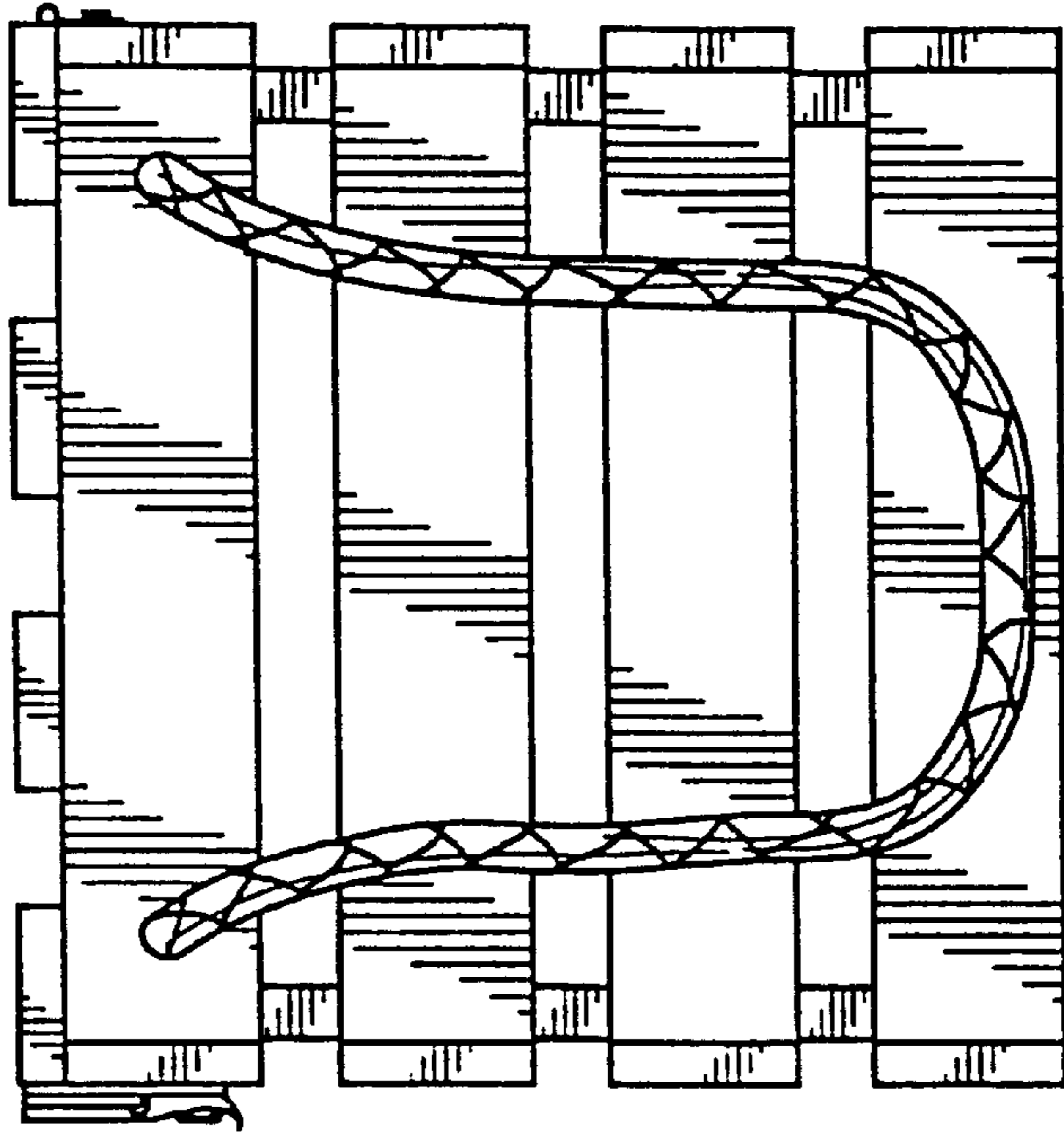

FIG. 5

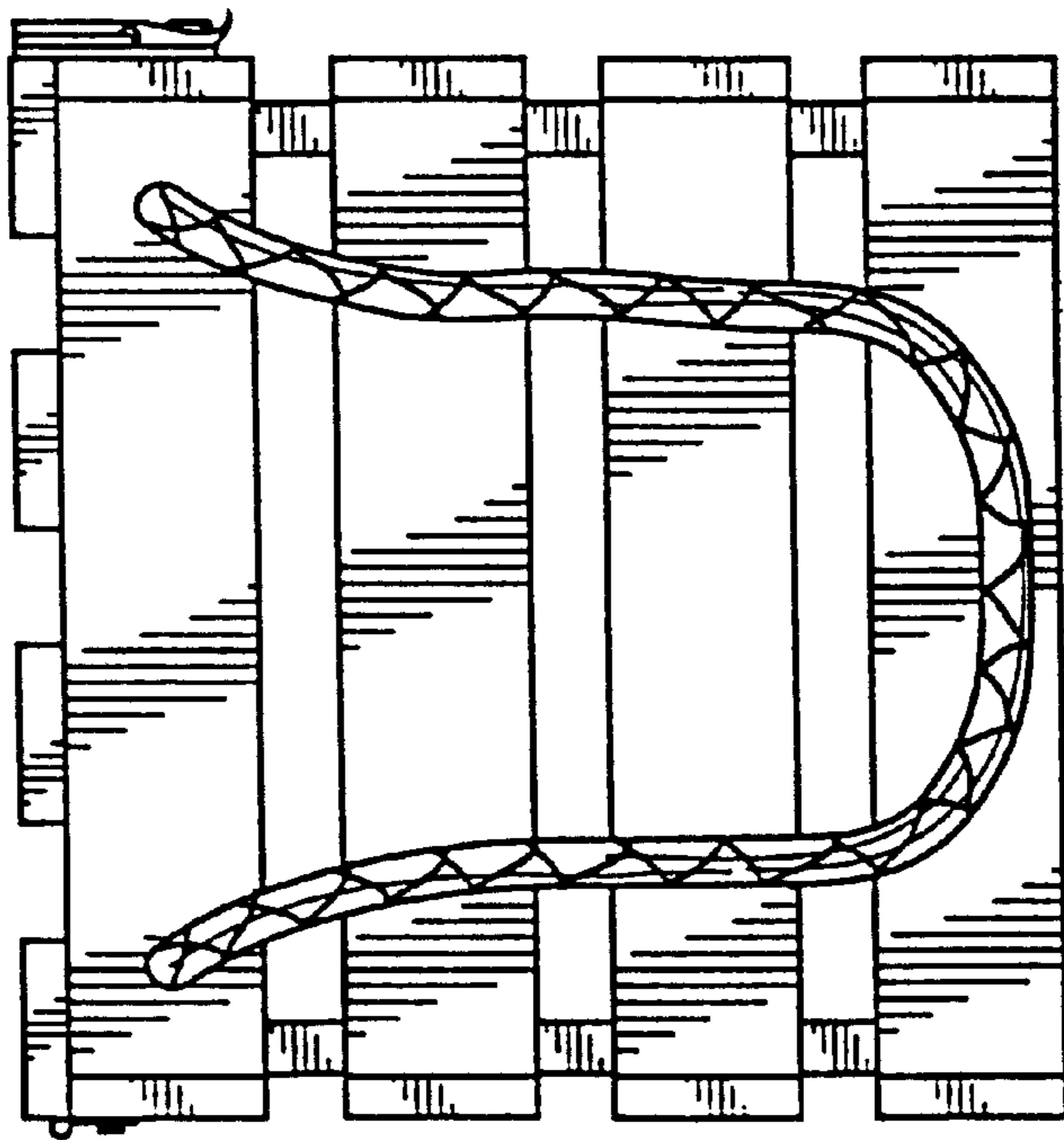

FIG. 4

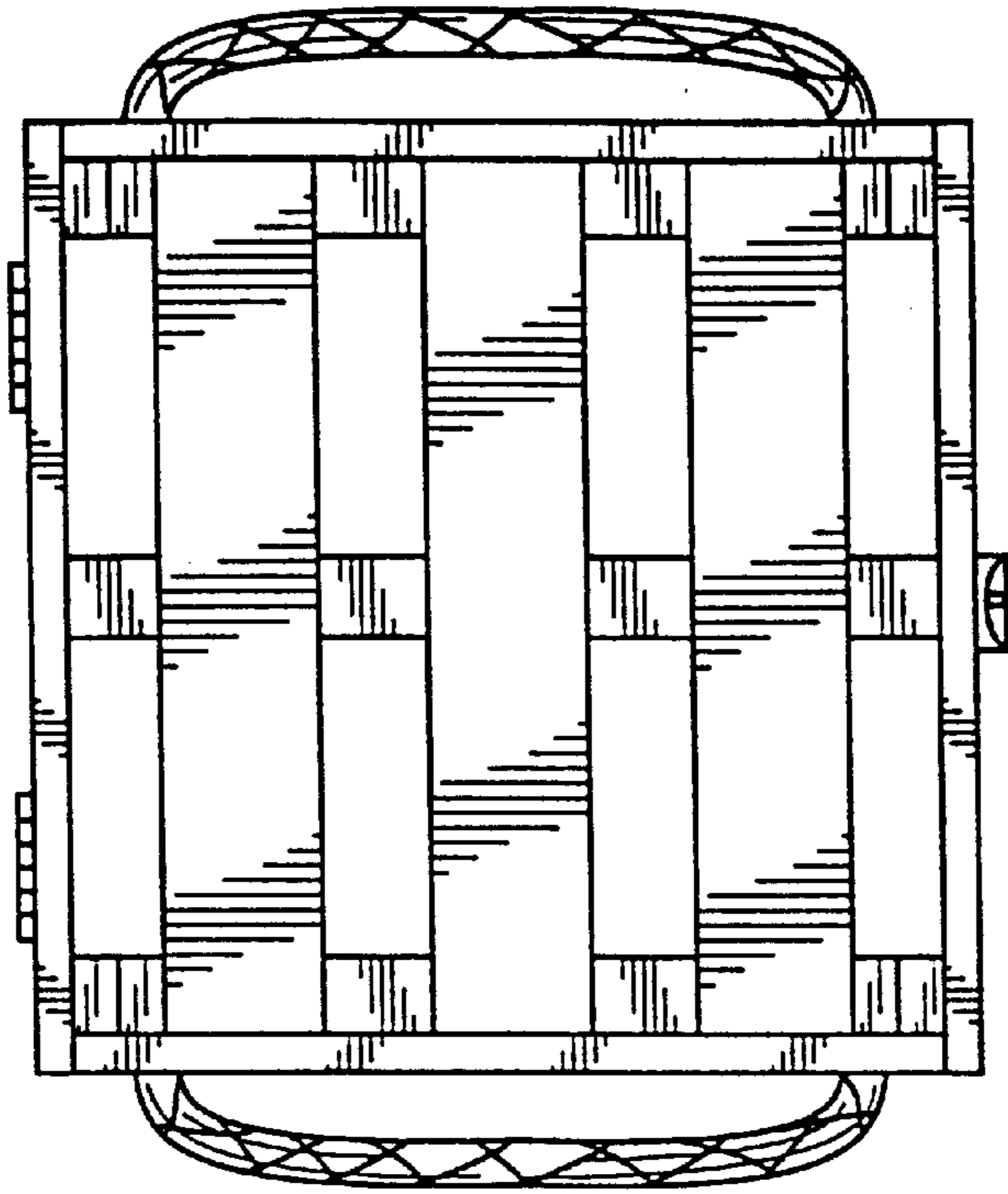

FIG. 7

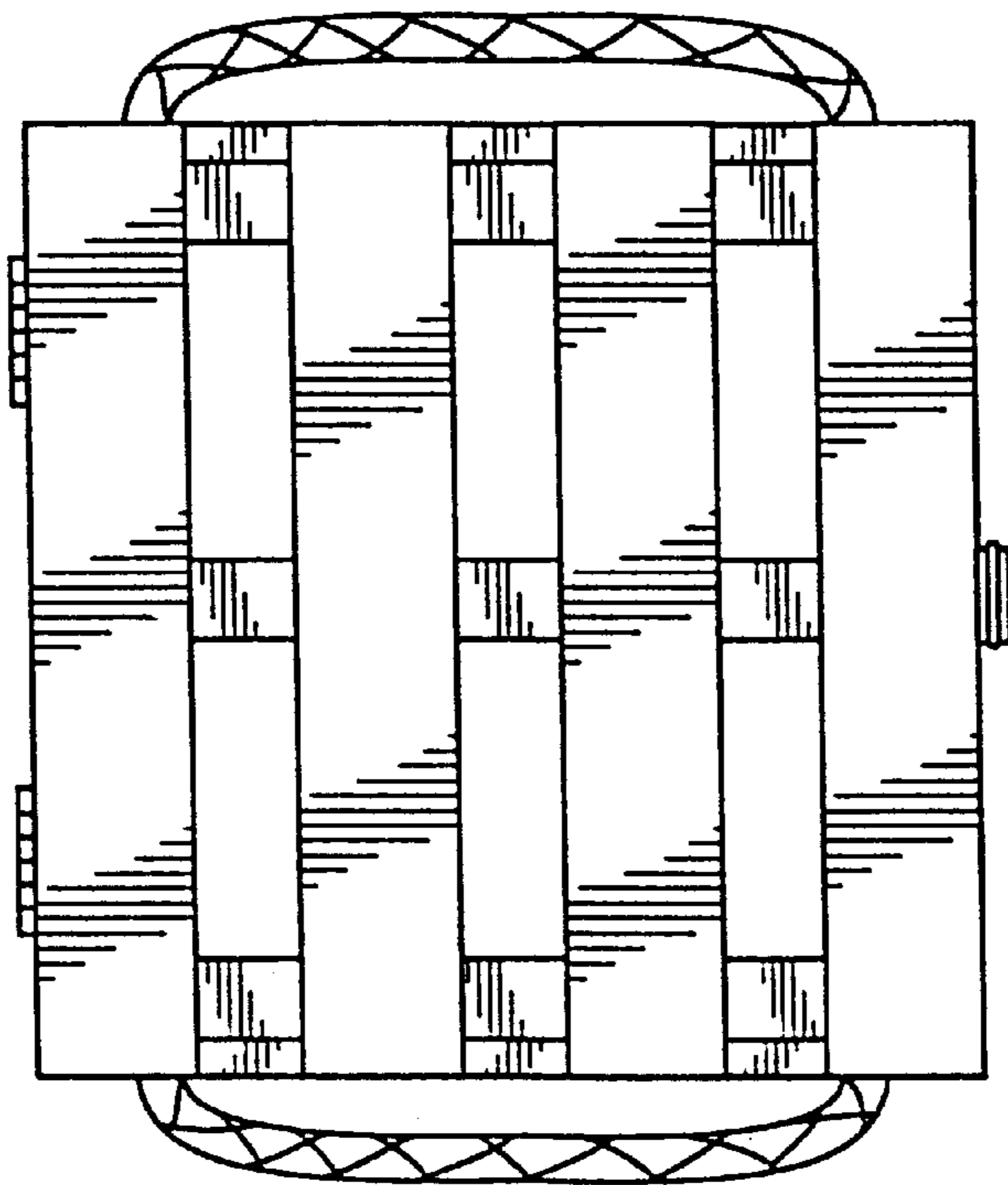

FIG. 6