



US00D451133B1

(12) **United States Design Patent**
Moor

(10) **Patent No.:** **US D451,133 S**

(45) **Date of Patent:** **** Nov. 27, 2001**

(54) **NOTEBOOK ORGANIZER**

(75) **Inventor:** **Marc L. Moor**, Oakwood, OH (US)

(73) **Assignee:** **The Mead Corporation**, Dayton, OH (US)

(**) **Term:** **14 Years**

(21) **Appl. No.:** **29/132,647**

(22) **Filed:** **Nov. 13, 2000**

(51) **LOC (7) Cl.** **19-04**

(52) **U.S. Cl.** **D19/26**

(58) **Field of Search** D19/26, 27, 32,
D19/33; 402/2, 18; 281/3.1, 2, 5, 15.1,
21.1, 29, 31, 19.1; 229/72; 150/147, 135;
D3/301, 303, 232, 900

(56) **References Cited**

U.S. PATENT DOCUMENTS

D. 182,059	2/1958	Chase .	
D. 312,277	* 11/1990	Moor	D19/27
D. 314,977	* 2/1991	Wyant	D19/27
D. 322,458	12/1991	Wiberg .	
D. 435,863	* 1/2001	Eskandry	D19/27
1,743,305	1/1930	Banks .	
1,794,560	3/1931	Styll .	
1,928,337	* 9/1933	McClanahan	229/72
2,299,319	10/1942	Gale .	
2,788,041	* 4/1957	Carver	150/147
2,828,975	* 4/1958	Wright	281/31
3,870,223	* 3/1975	Wyant	229/72
4,573,821	3/1986	Gilreath .	
4,784,508	11/1988	Shannon .	

4,932,683	6/1990	Perazza .	
4,973,086	11/1990	Donnelly et al. .	
5,123,676	6/1992	Donnelly et al. .	
5,170,889	12/1992	Cue .	
5,242,197	9/1993	Raynak .	
5,320,275	6/1994	Williams .	
5,333,908	8/1994	Dorney et al. .	
5,503,435	4/1996	Kline .	
5,513,457	5/1996	Byrnes et al. .	
5,749,666	5/1998	Yu .	
5,797,630	8/1998	Conley, Jr. .	
6,089,608	* 7/2000	Exline	281/21.1

* cited by examiner

Primary Examiner—Paula A. Mortimer

(74) *Attorney, Agent, or Firm*—Thompson Hine LLP

(57) **CLAIM**

The ornamental design for a notebook organizer, as shown.

DESCRIPTION

FIG. 1 is a front perspective view of the notebook organizer of the present invention, shown in its open position; FIG. 2 is a front view of the notebook organizer of FIG. 1; FIG. 3 is a top end view of the notebook organizer of FIG. 1; FIG. 4 is a bottom end view of the notebook organizer of FIG. 1; FIG. 5 is a left side view of the notebook organizer of FIG. 1; FIG. 6 is a right side view of the notebook organizer of FIG. 1; and, FIG. 7 is a back view of the notebook organizer of FIG. 1.

1 Claim, 4 Drawing Sheets

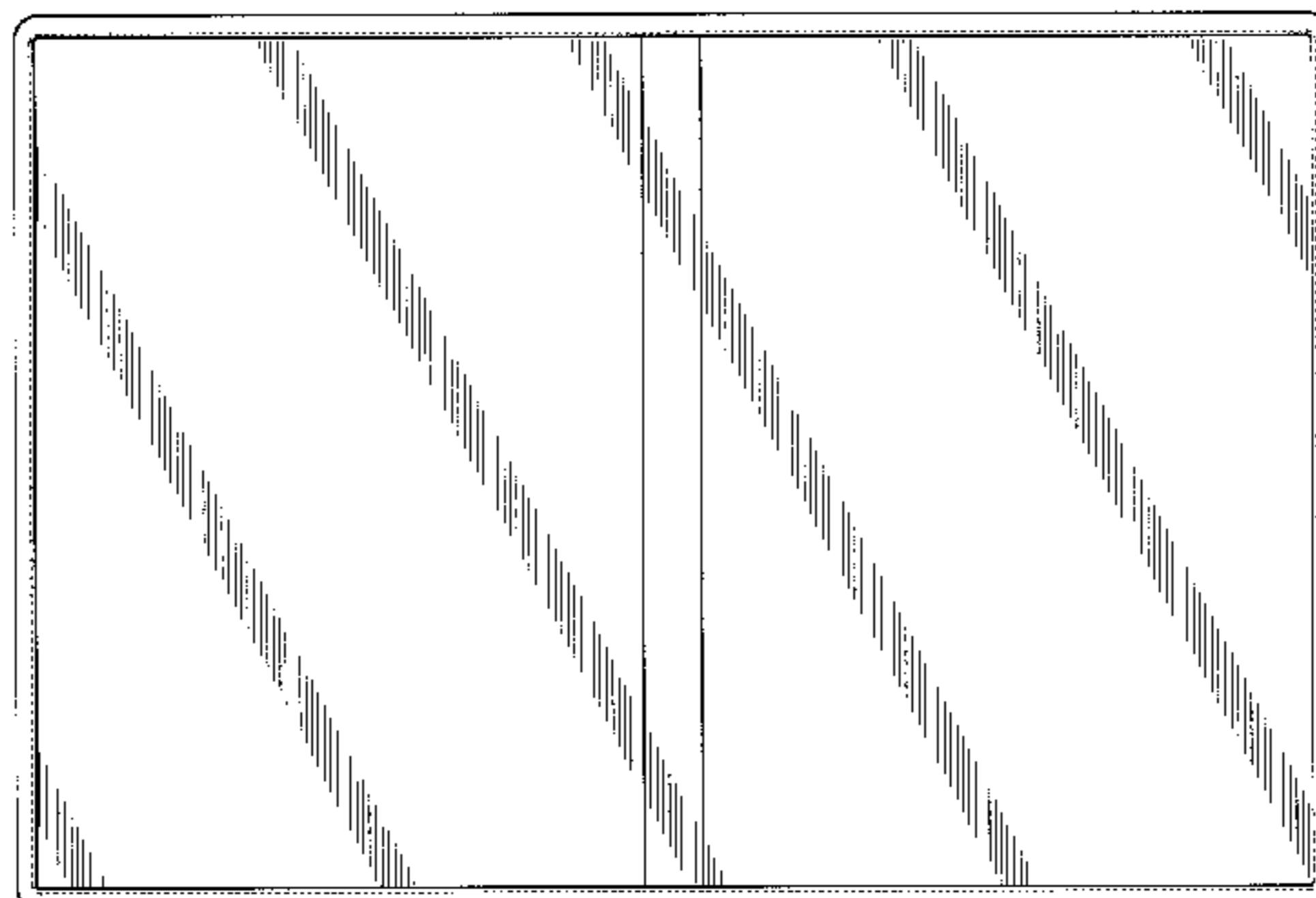
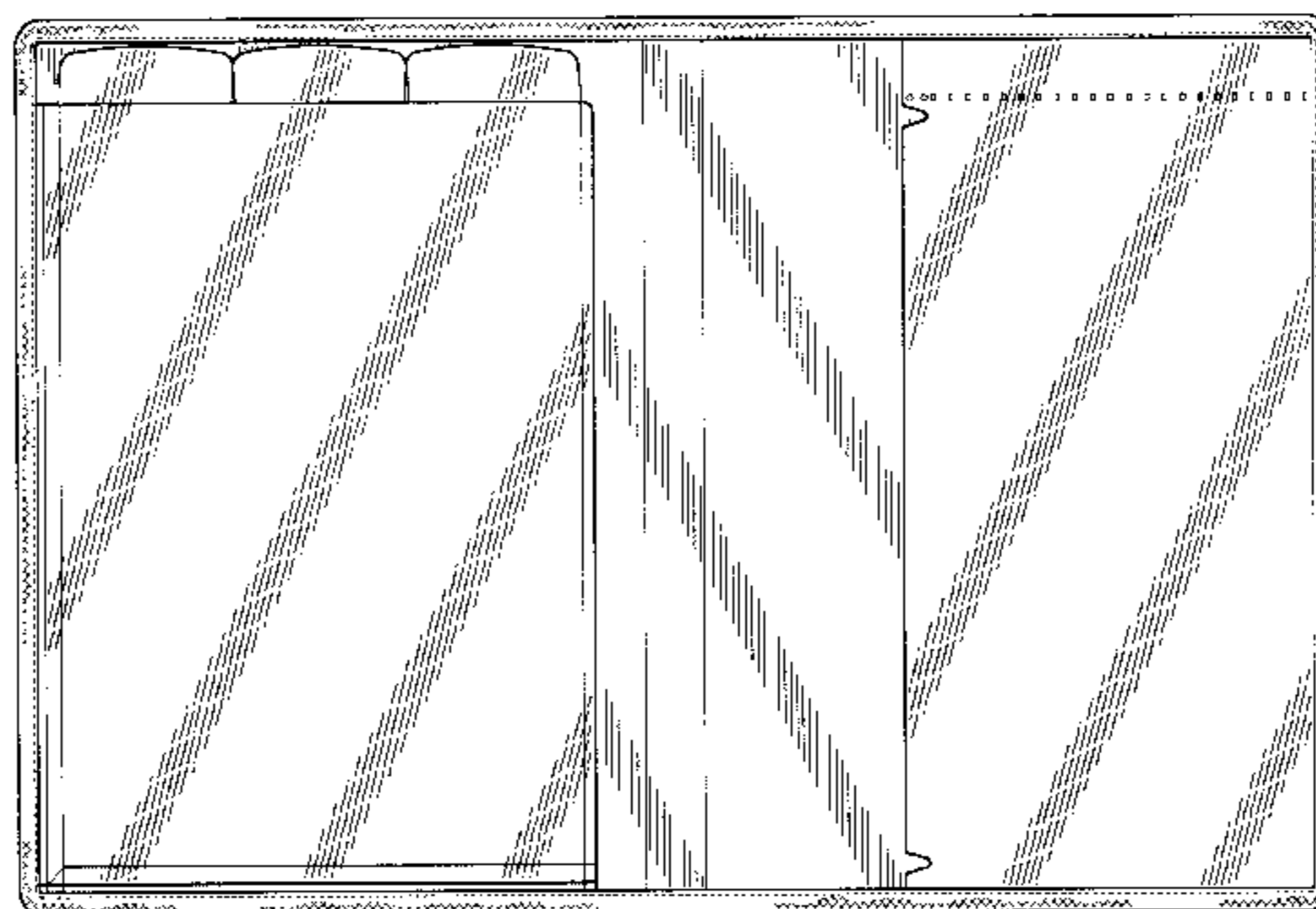

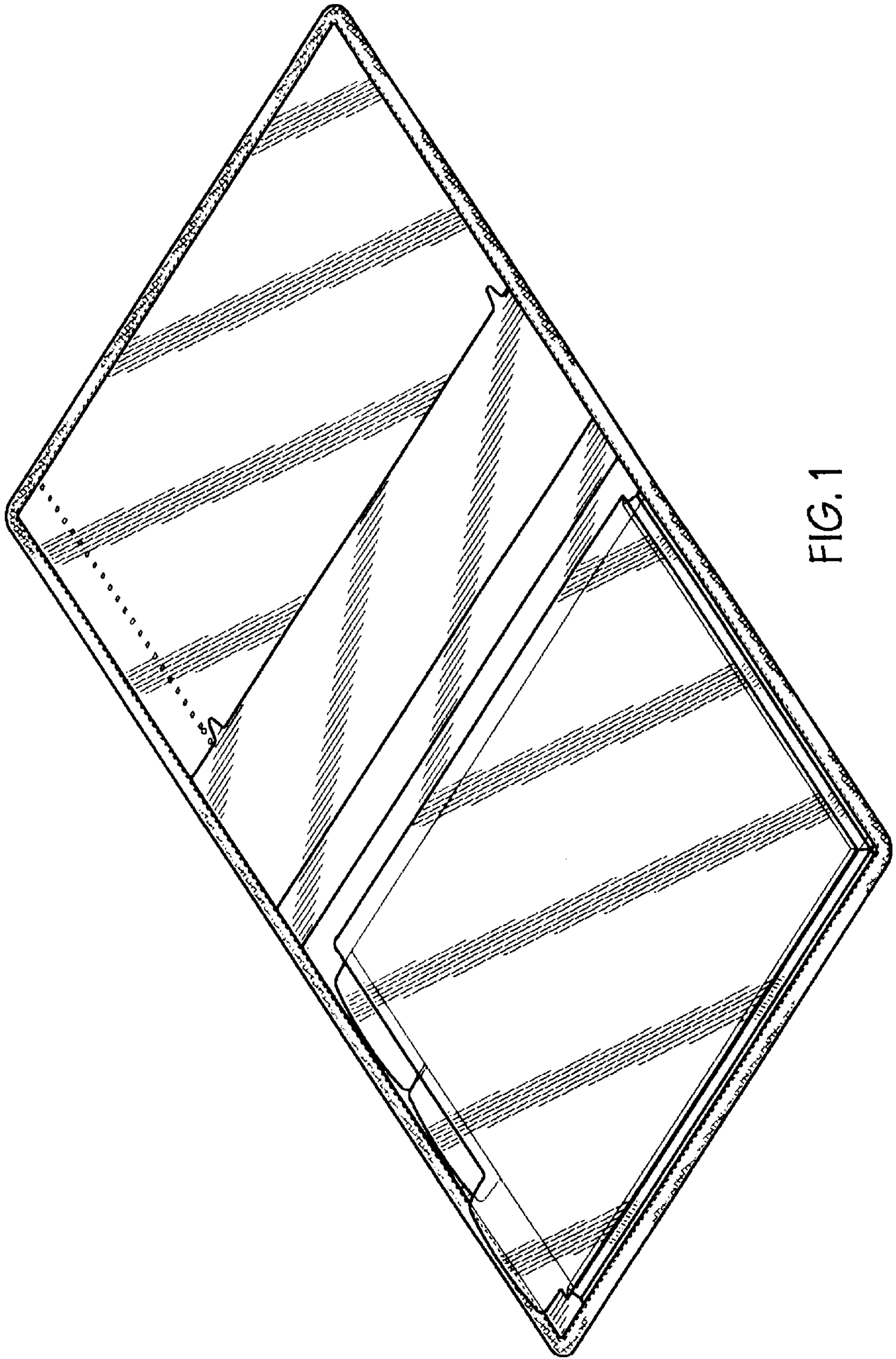

FIG. 1

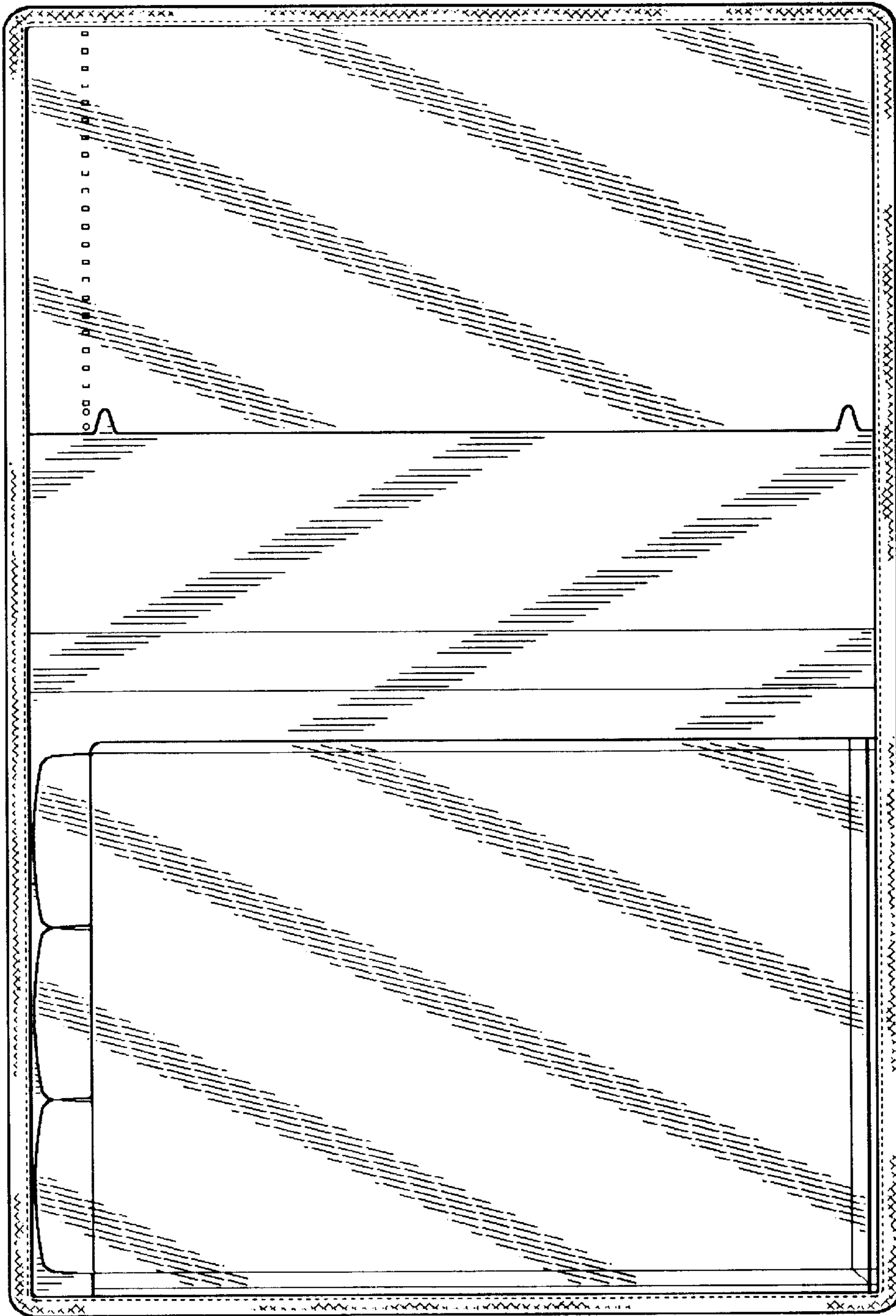

FIG. 2

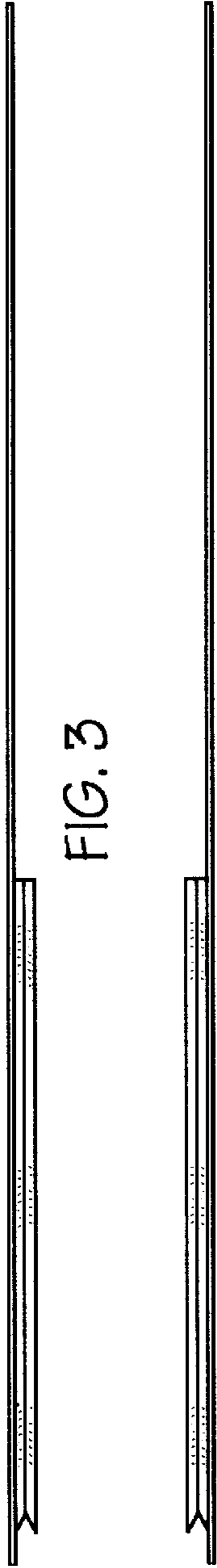

FIG. 3

FIG. 4

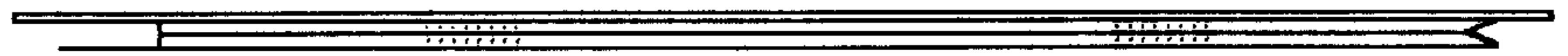

FIG. 6

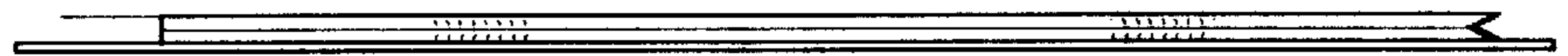

FIG. 5

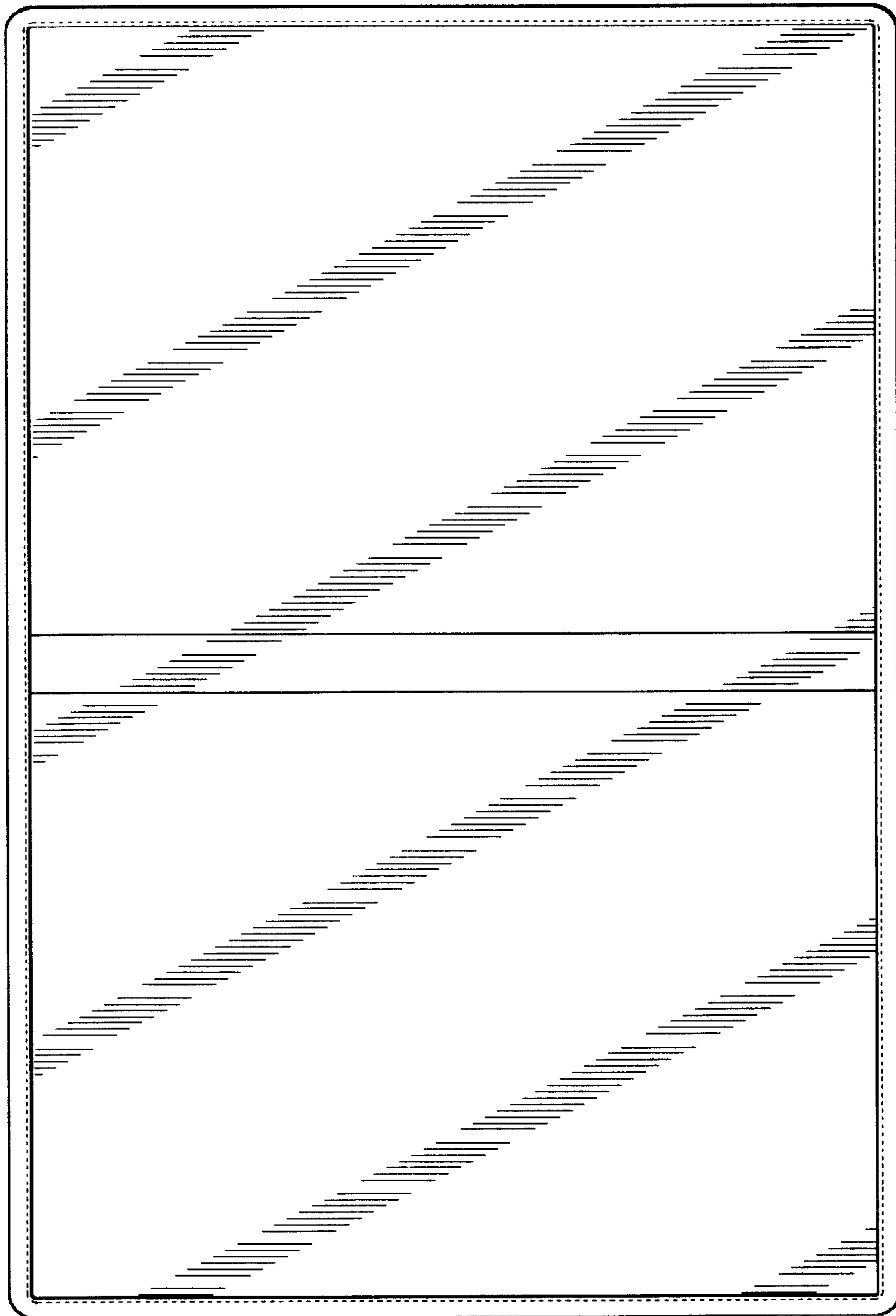

FIG. 7