



US00D450997B1

(12) **United States Design Patent**
Brady

(10) **Patent No.:** **US D450,997 S**

(45) **Date of Patent:** **** Nov. 27, 2001**

- (54) **KNOB**
- (75) **Inventor:** **Martin Brady**, Chesterfield, VA (US)
- (73) **Assignee:** **Hamilton Beach/Proctor-Silex, Inc.**,
Glen Allen, VA (US)
- (**) **Term:** **14 Years**
- (21) **Appl. No.:** **29/140,113**
- (22) **Filed:** **Apr. 12, 2001**
- (51) **LOC (7) Cl.** **08-06**
- (52) **U.S. Cl.** **D8/311**
- (58) **Field of Search** D8/300, 307-312;
D7/393, 395; 16/110.1, 412-417, 419, 420,
441, 443; 116/309, 319, 320; 74/553; D23/250-254

- 3,581,028 5/1971 Valbona .
- 5,974,028 11/1999 Bauer et al. .
- 6,105,461 8/2000 Bauer et al. .

OTHER PUBLICATIONS

Knob, 6 pictures attached, date unknown.

* cited by examiner

Primary Examiner—B. J. Bullock

(74) *Attorney, Agent, or Firm*—Atkin, Gump, Strauss,
Hauer & Feld, L.L.P.

(57) **CLAIM**

The ornamental design for a knob, as shown and described.

DESCRIPTION

FIG. 1 is a front perspective view of a knob in accordance with a first preferred embodiment of my new design; FIG. 2 is a right side elevational view thereof, a mirror image of which is a left side elevational view thereof; FIG. 3 is a front elevational view thereof; FIG. 4 is a rear elevational view thereof; FIG. 5 is a top plan view thereof; FIG. 6 is a bottom plan view thereof; FIG. 7 is a front perspective view of a knob in accordance with a second preferred embodiment of my new design; FIG. 8 is a right side elevational view thereof, a mirror image of which is a left side elevational view thereof; FIG. 9 is a front elevational view thereof; FIG. 10 is a rear elevational view thereof; FIG. 11 is a top plan view thereof; and, FIG. 12 is a bottom plan view thereof.

The broken lines showing the rear portion of the knob is for illustrative purposes only and forms no part of the claimed design.

(56) **References Cited**

U.S. PATENT DOCUMENTS

- D. 141,840 7/1945 Stewart .
- D. 145,188 7/1946 Stewart .
- D. 165,119 * 11/1951 Stuman .
- D. 166,874 * 5/1952 Reed .
- D. 315,272 3/1991 Moore et al. .
- D. 315,273 3/1991 Myerly .
- D. 328,685 8/1992 Wolfe .
- D. 369,938 5/1996 Figur .
- D. 379,899 6/1997 Barthelemy et al. .
- D. 427,838 7/2000 Lee .
- 2,235,723 3/1941 Myers .
- 2,420,985 5/1947 Simpson .
- 2,537,782 * 1/1951 Meyers .
- 2,744,995 5/1956 Jepson .
- 2,749,903 6/1956 Auster .
- 2,815,230 12/1957 Howie .
- 2,957,447 10/1960 Pearce .
- 3,188,124 6/1965 Pestka et al. .
- 3,534,706 10/1970 Crispell .

1 Claim, 1 Drawing Sheet

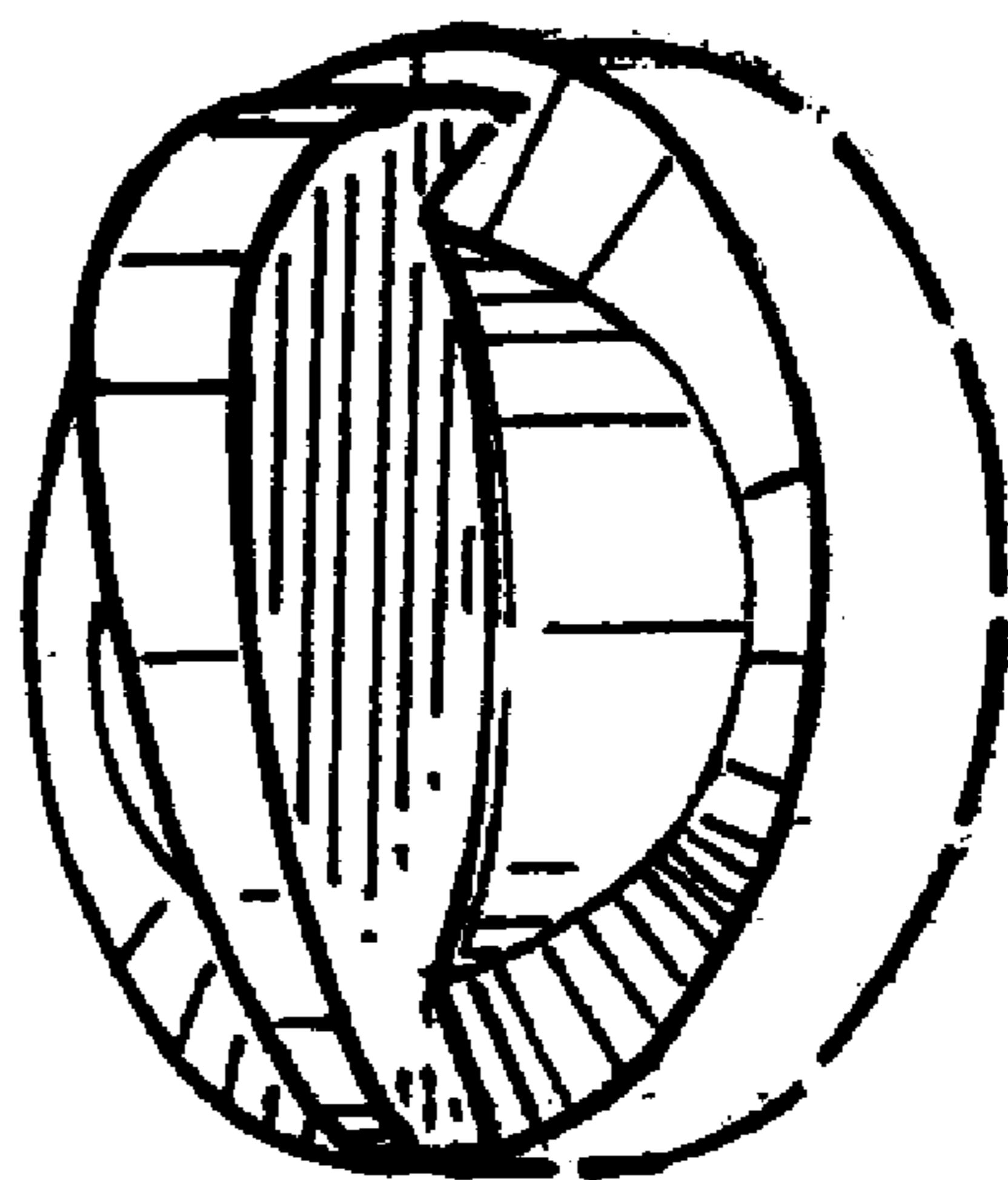
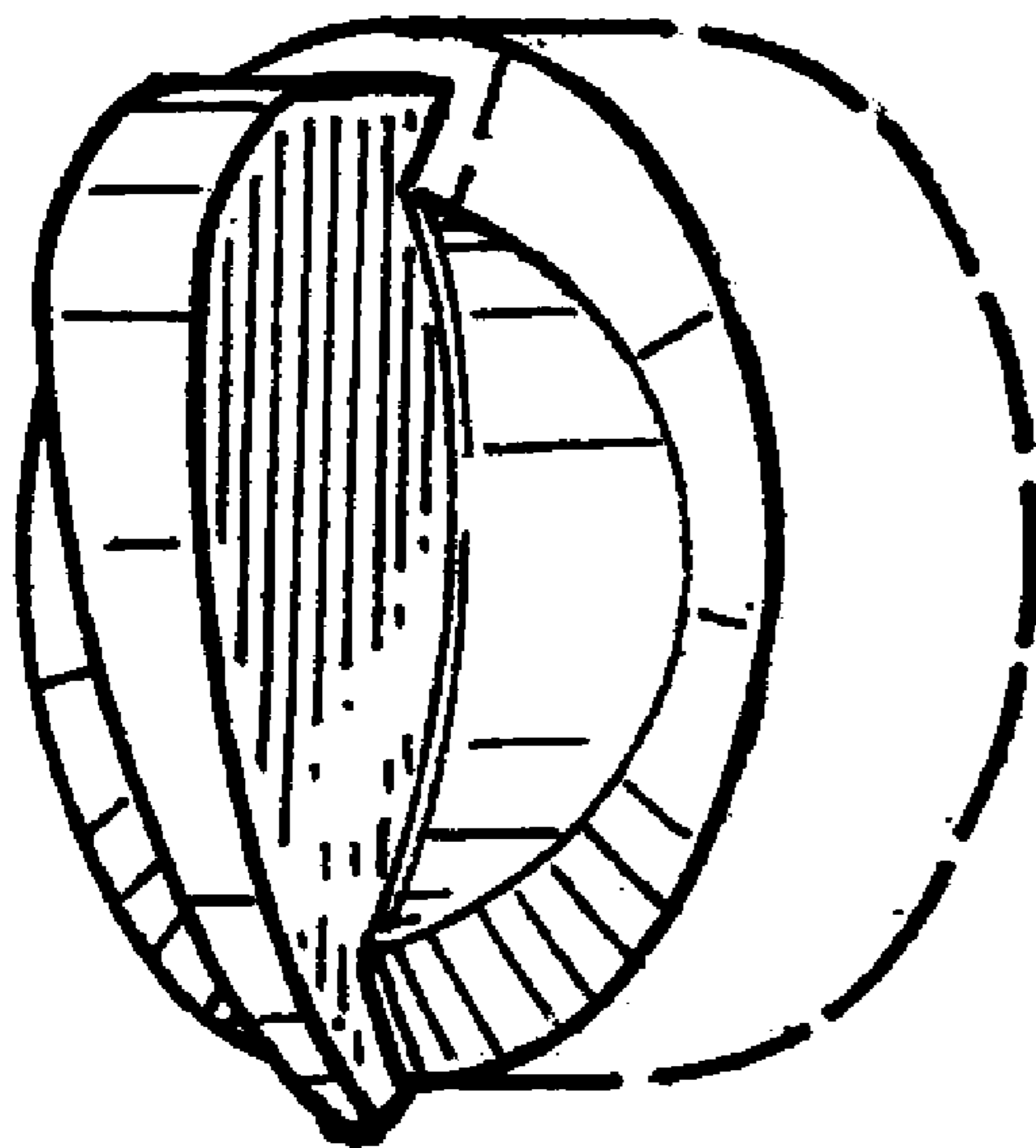

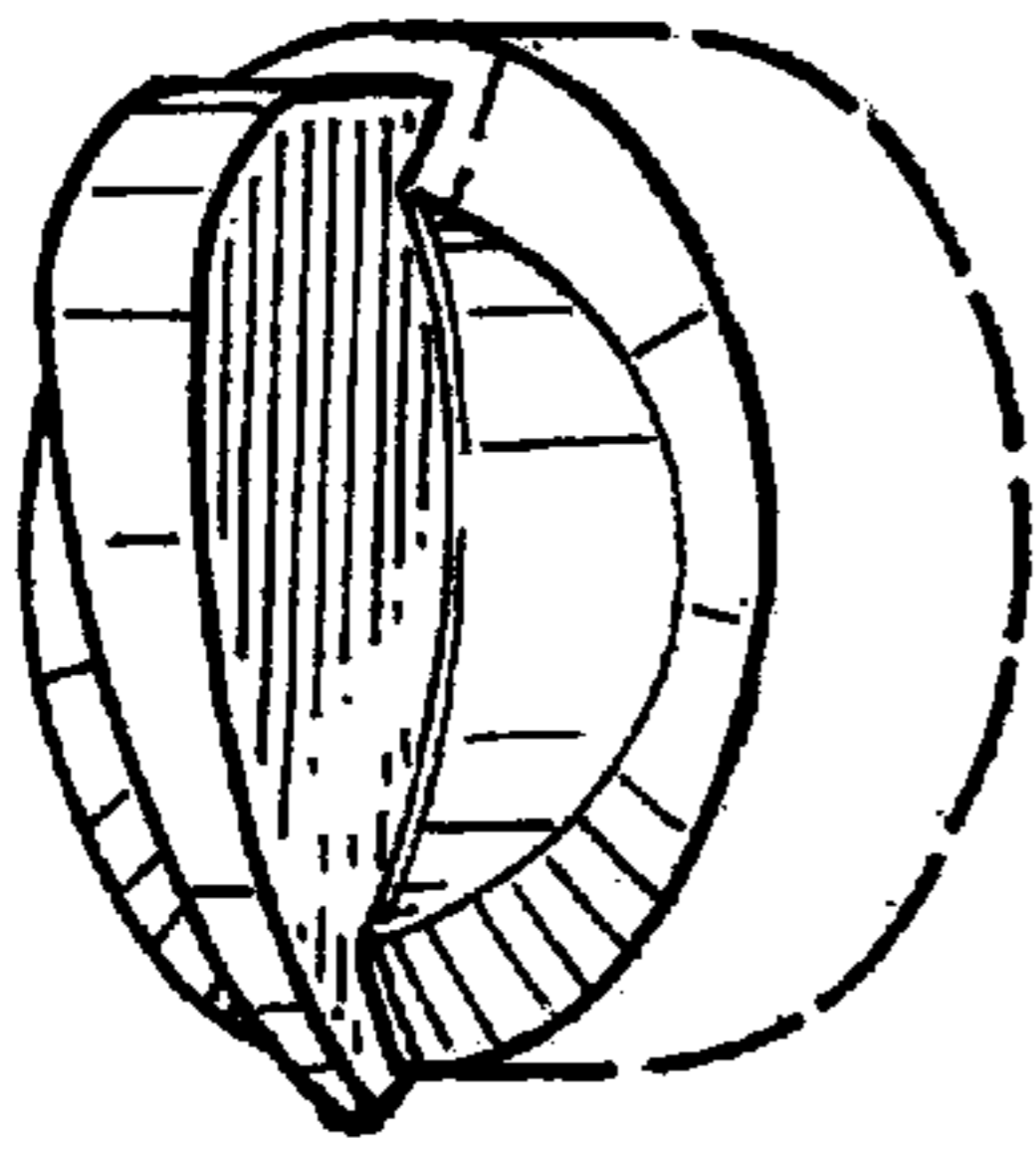

FIG. 1

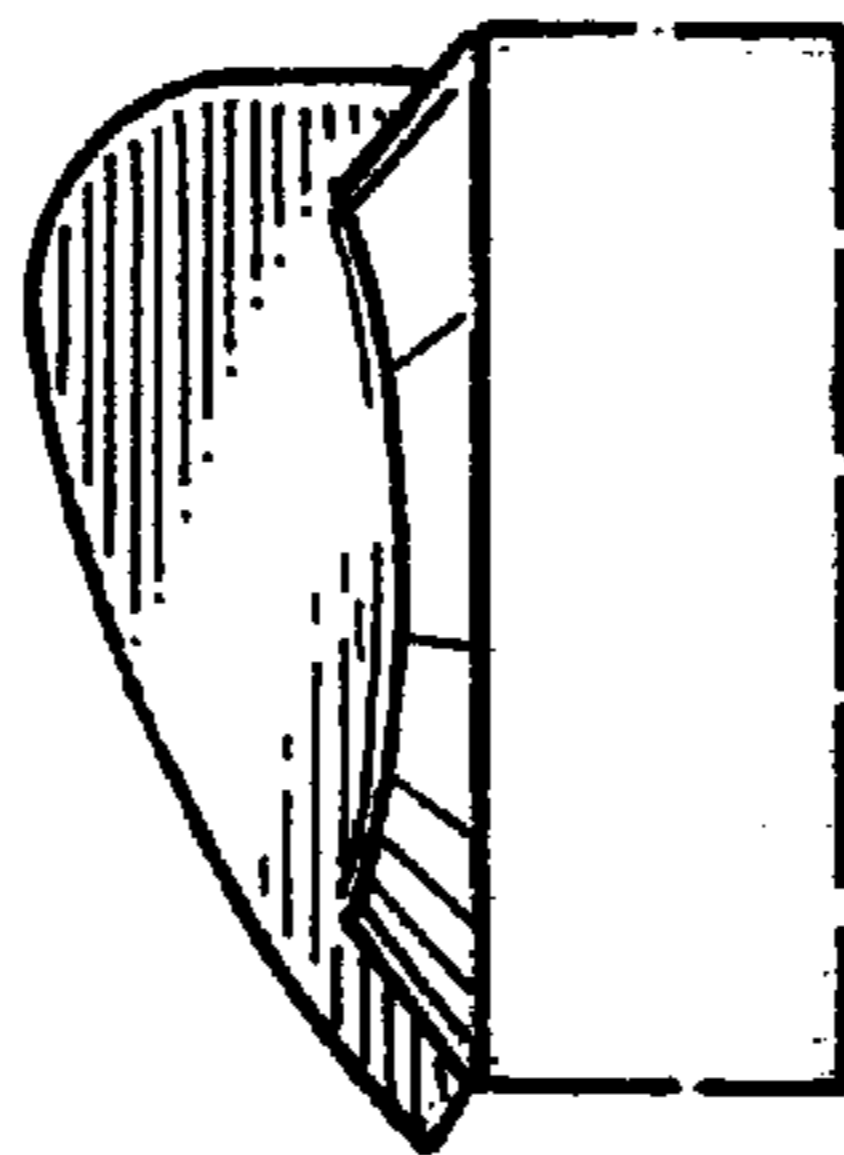

FIG. 2

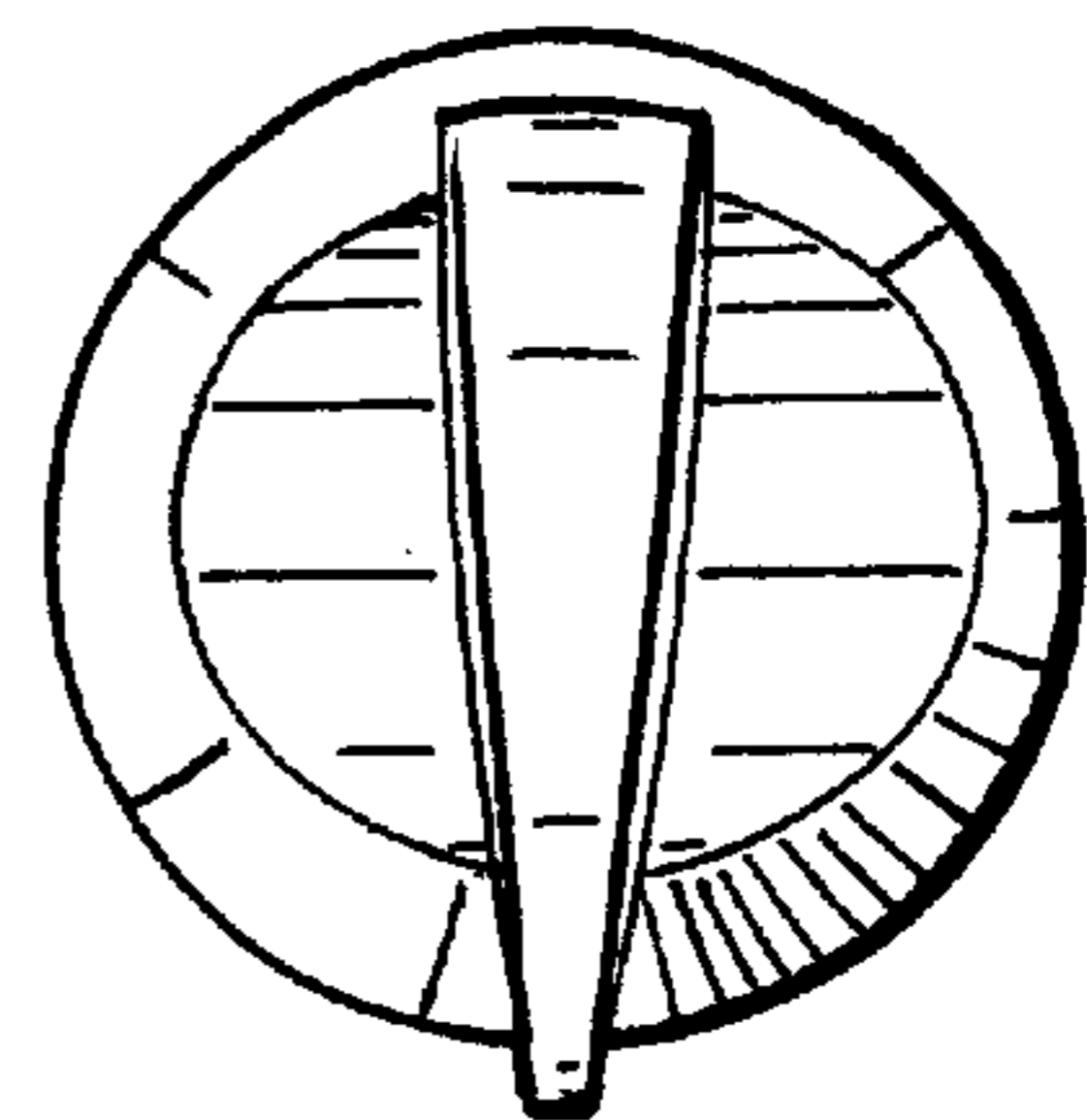

FIG. 3

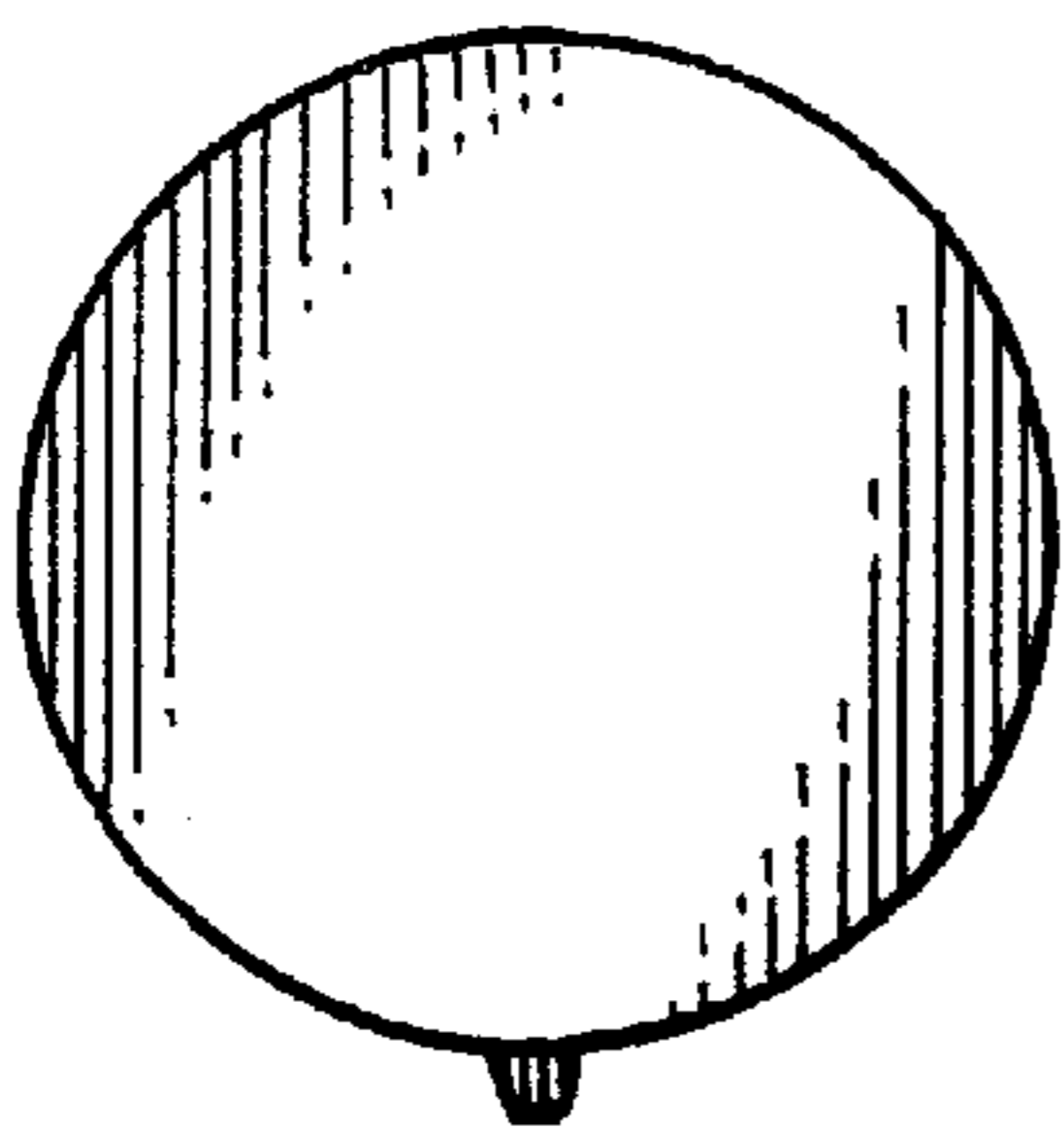

FIG. 4

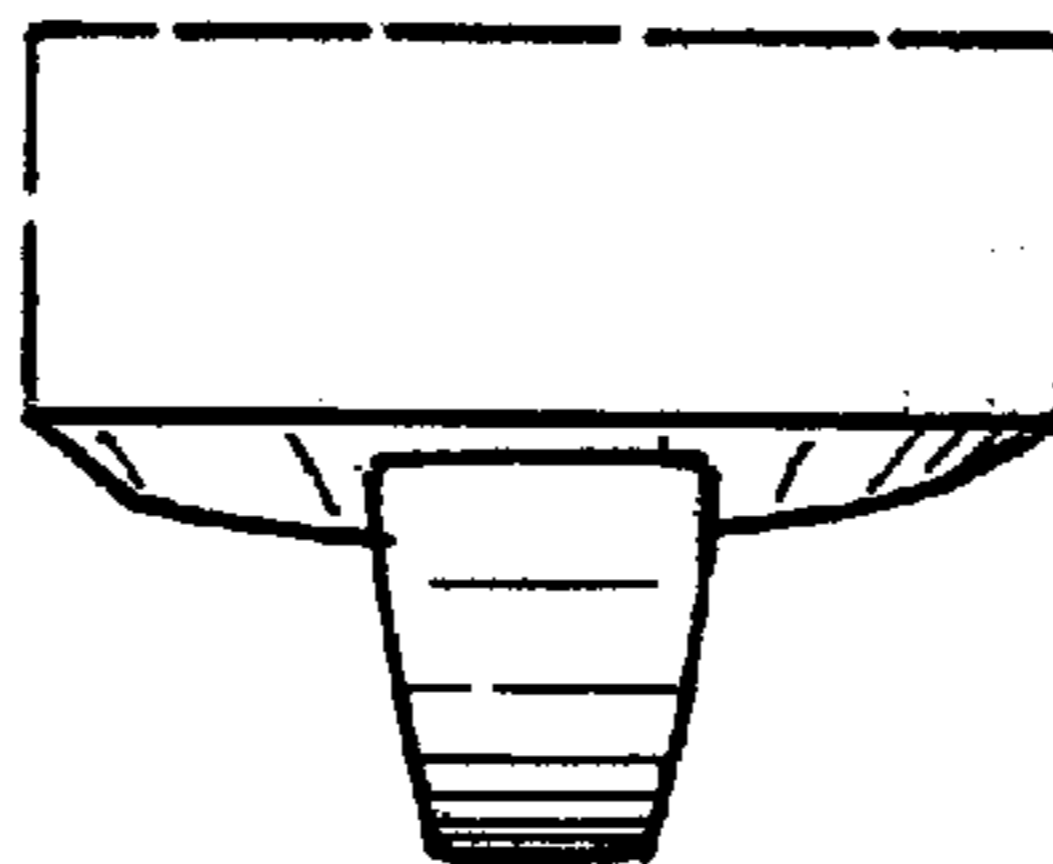

FIG. 5

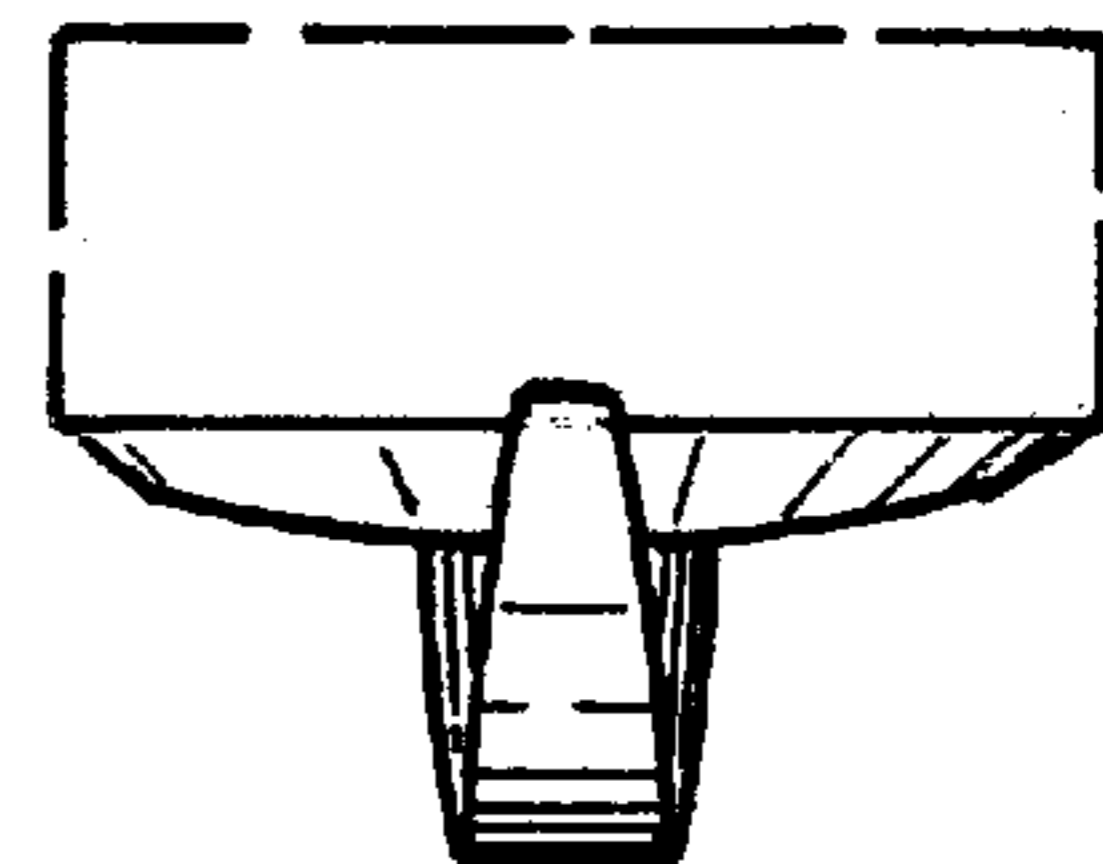

FIG. 6

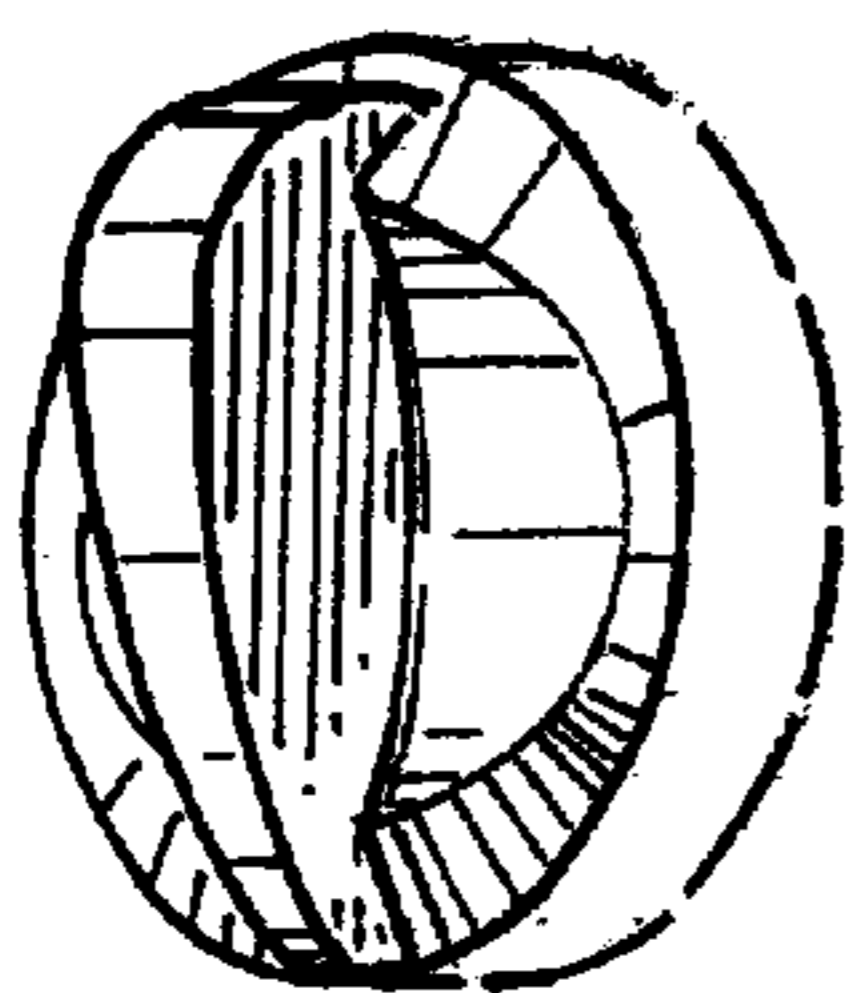

FIG. 7

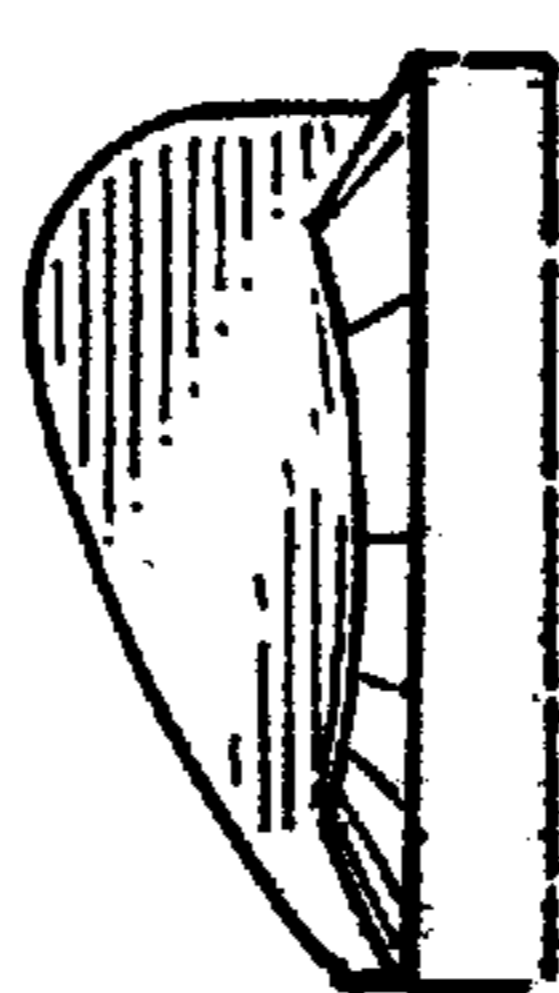

FIG. 8

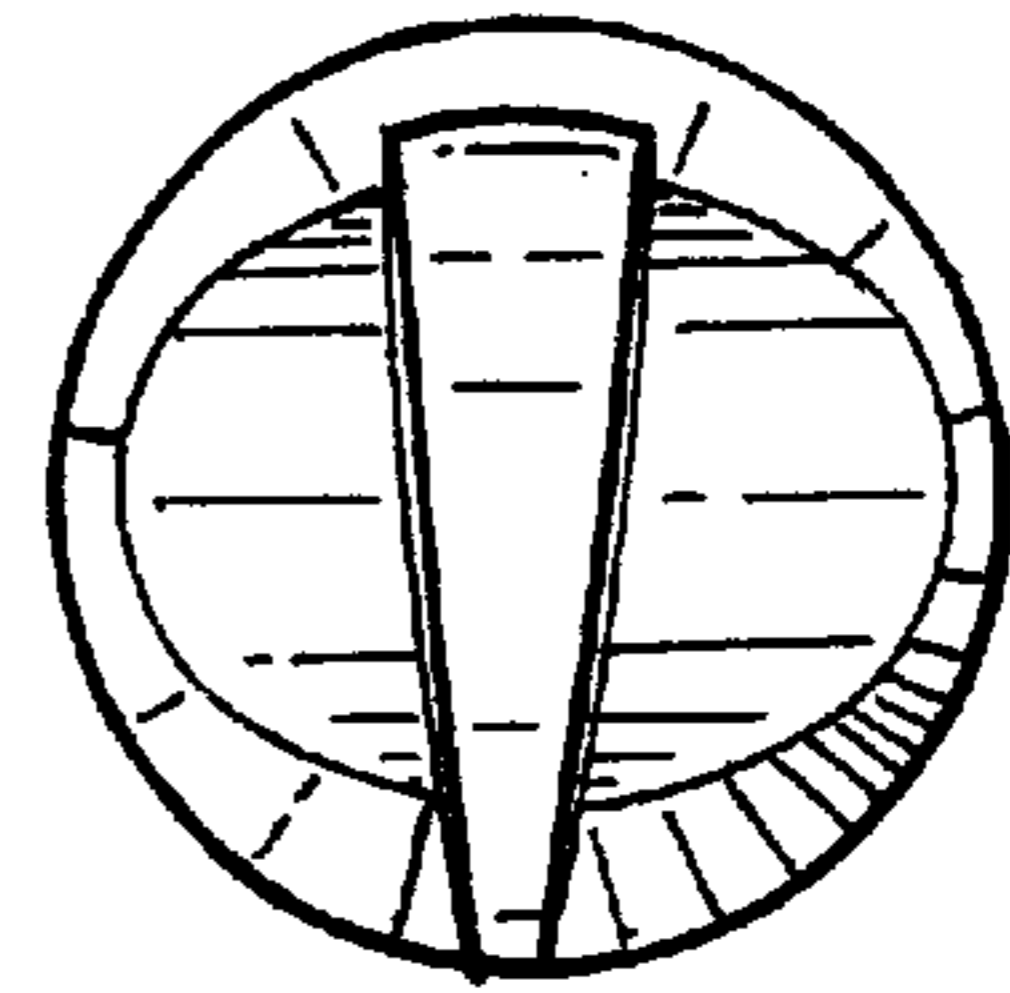

FIG. 9

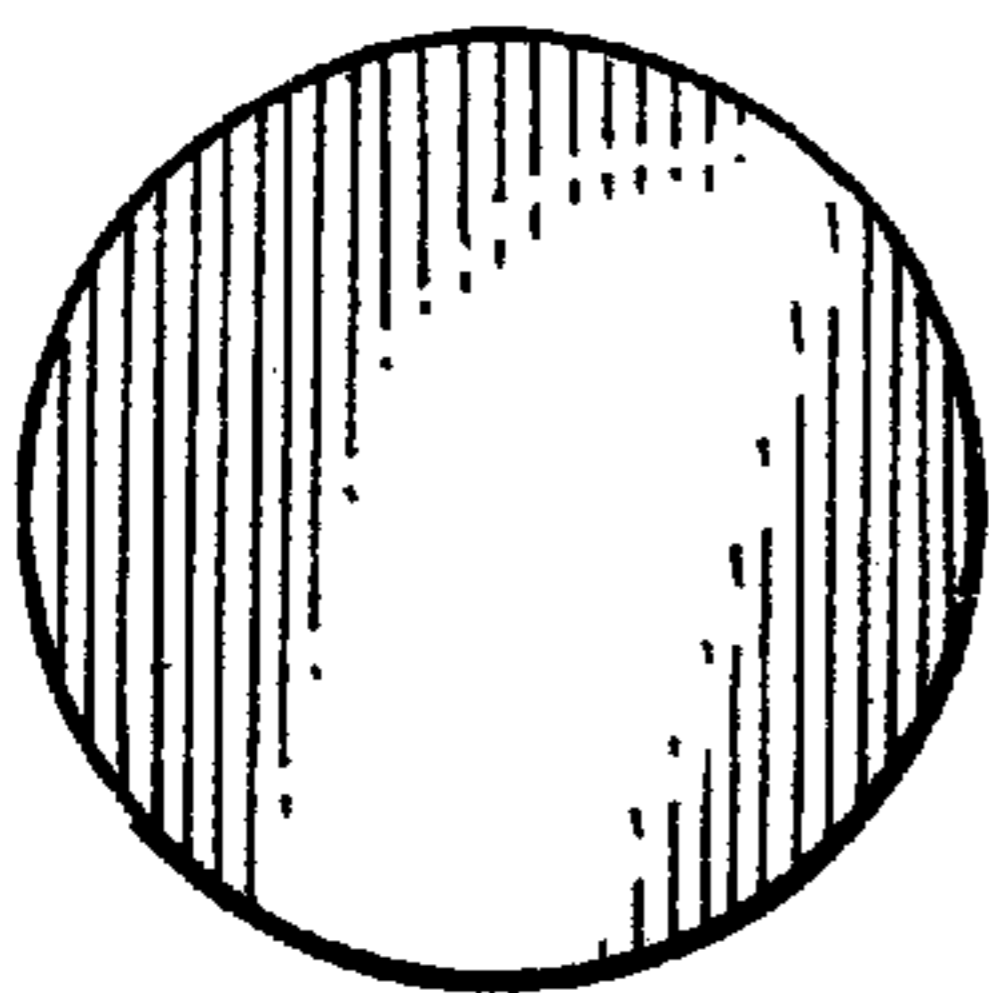

FIG. 10

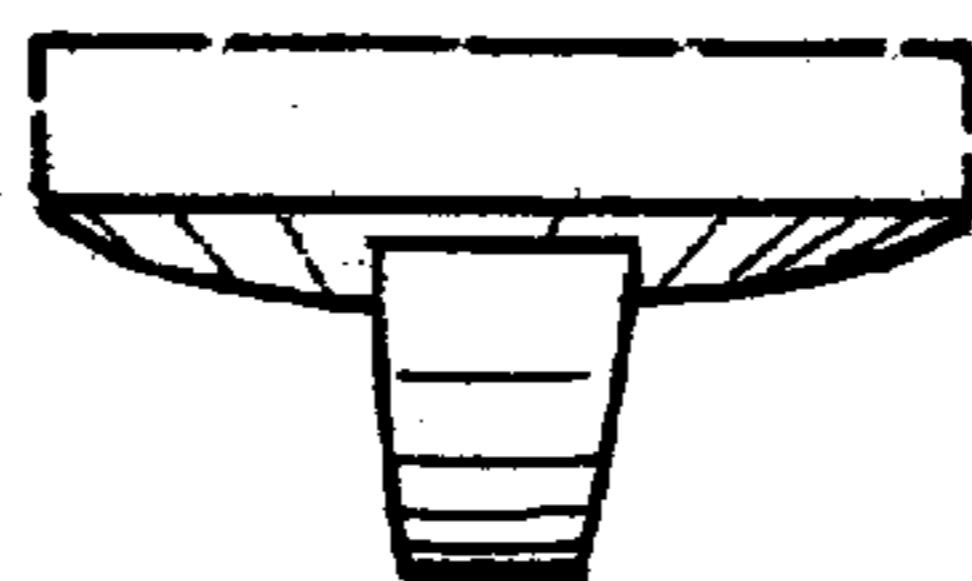

FIG. 11

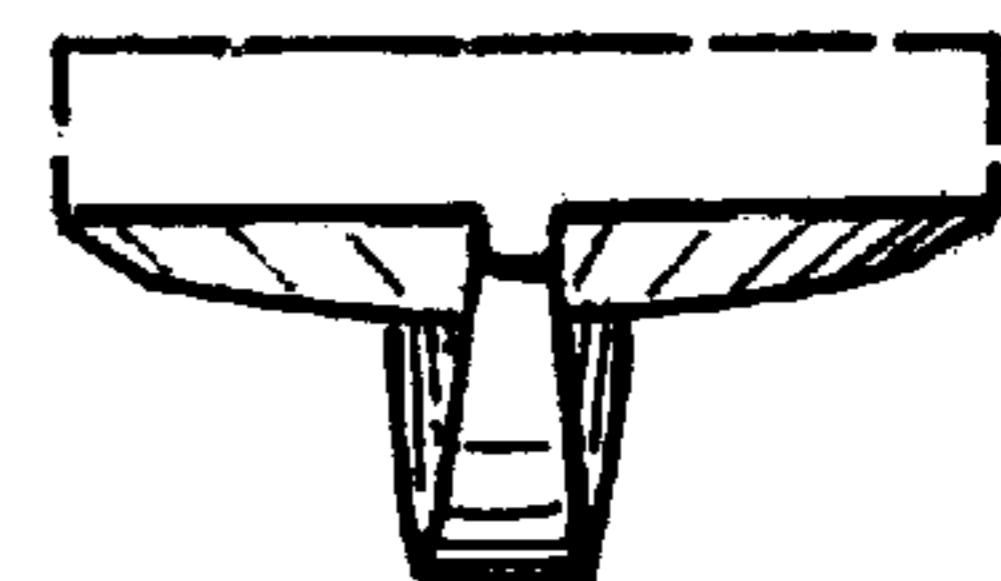

FIG. 12