



US00D450844B1

(12) **United States Design Patent**
Lewis

(10) **Patent No.:** **US D450,844 S**

(45) **Date of Patent:** **** Nov. 20, 2001**

(54) **OSTEOTOME BLADE**

(75) Inventor: **Randall J. Lewis**, Washington, DC
(US)

(73) Assignee: **Zimmer, Inc.**, Warsaw, IN (US)

(**) Term: **14 Years**

(21) Appl. No.: **29/137,351**

(22) Filed: **Feb. 16, 2001**

(51) **LOC (7) Cl.** **24-02**

(52) **U.S. Cl.** **D24/146**

(58) **Field of Search** D24/146, 147;
606/79, 84, 87

(56) **References Cited**

U.S. PATENT DOCUMENTS

D. 331,113	*	11/1992	Buss et al.	D24/147
4,150,675	*	4/1979	Comparetto	606/84
4,600,005	*	7/1986	Hendel	606/84
4,750,481	*	6/1988	Reese	606/87
5,722,977	*	3/1998	Wilhelmy	606/84

* cited by examiner

Primary Examiner—Stella Reid

(74) *Attorney, Agent, or Firm*—Baker & Daniels

(57) **CLAIM**

The ornamental design for an osteotome blade, as shown and described.

DESCRIPTION

FIG. 1 is a perspective view of an osteotome blade showing a first embodiment of my new design.

FIG. 2 is a left side elevational view thereof.

FIG. 3 is a right side elevational view thereof.

FIG. 4 is a front elevational view thereof.

FIG. 5 is a rear elevational view thereof.

FIG. 6 is a top view thereof.

FIG. 7 is a bottom view thereof.

FIG. 8 is a perspective view of an osteotome blade showing a second embodiment of my new design.

FIG. 9 is a left side elevational view thereof.

FIG. 10 is a right side elevational view thereof.

FIG. 11 is a front elevational view thereof.

FIG. 12 is a rear elevational view thereof.

FIG. 13 is a top view thereof; and,

FIG. 14 is a bottom view thereof.

The broken lines showing an osteotome instrument in FIGS. 1 and 8 are for environmental purposes only and form no part of the claimed design.

1 Claim, 4 Drawing Sheets

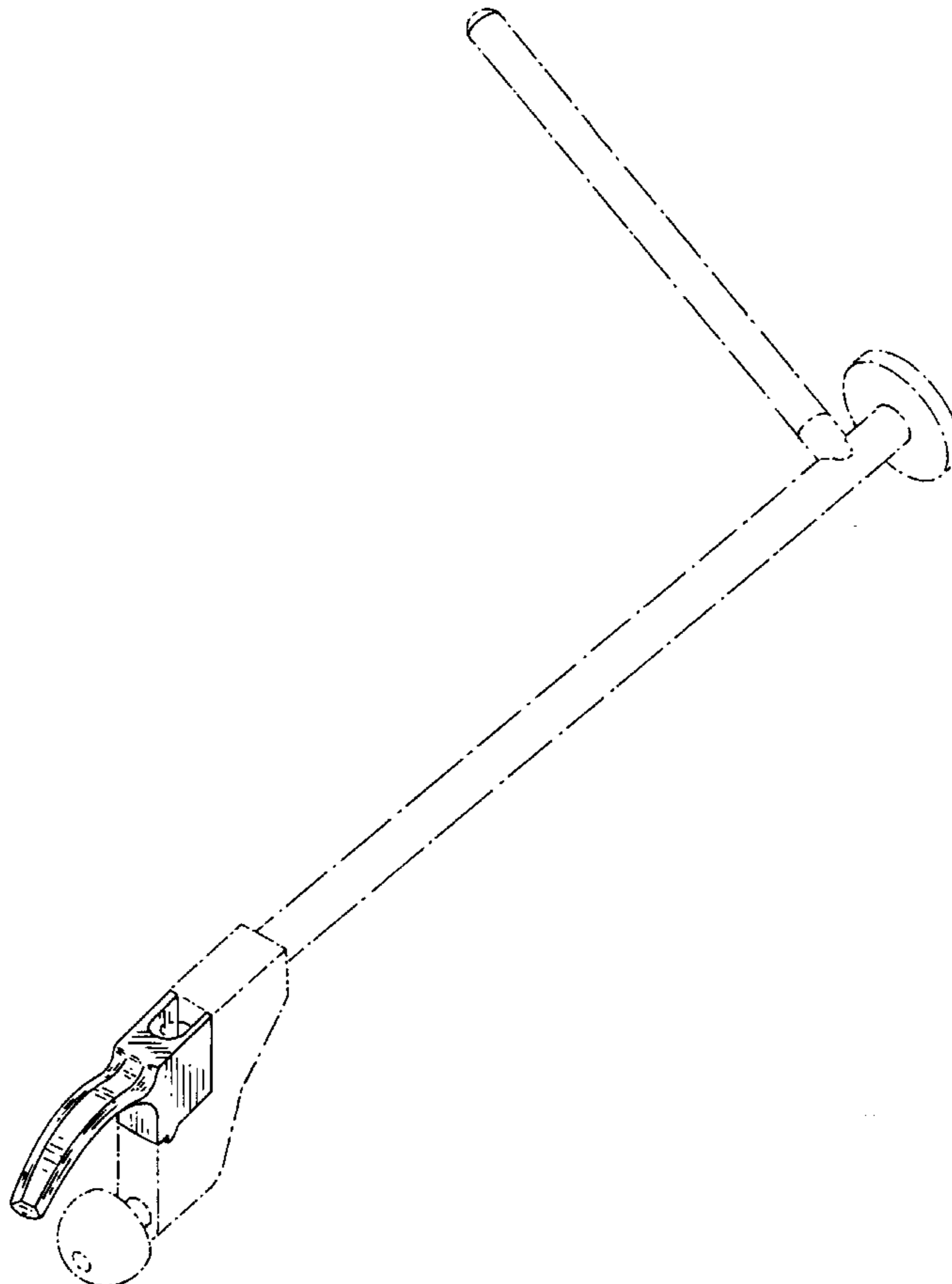

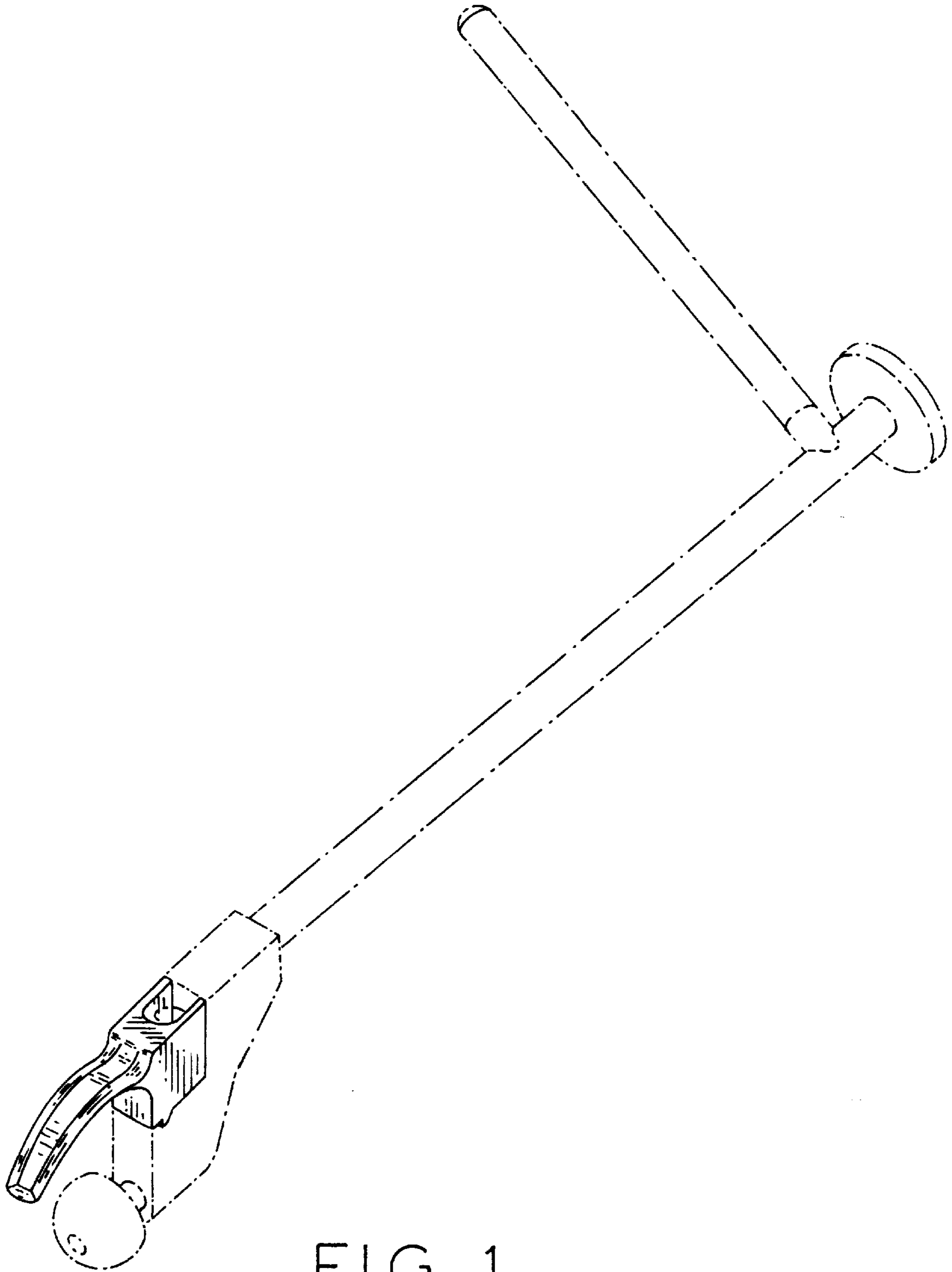

FIG. 1

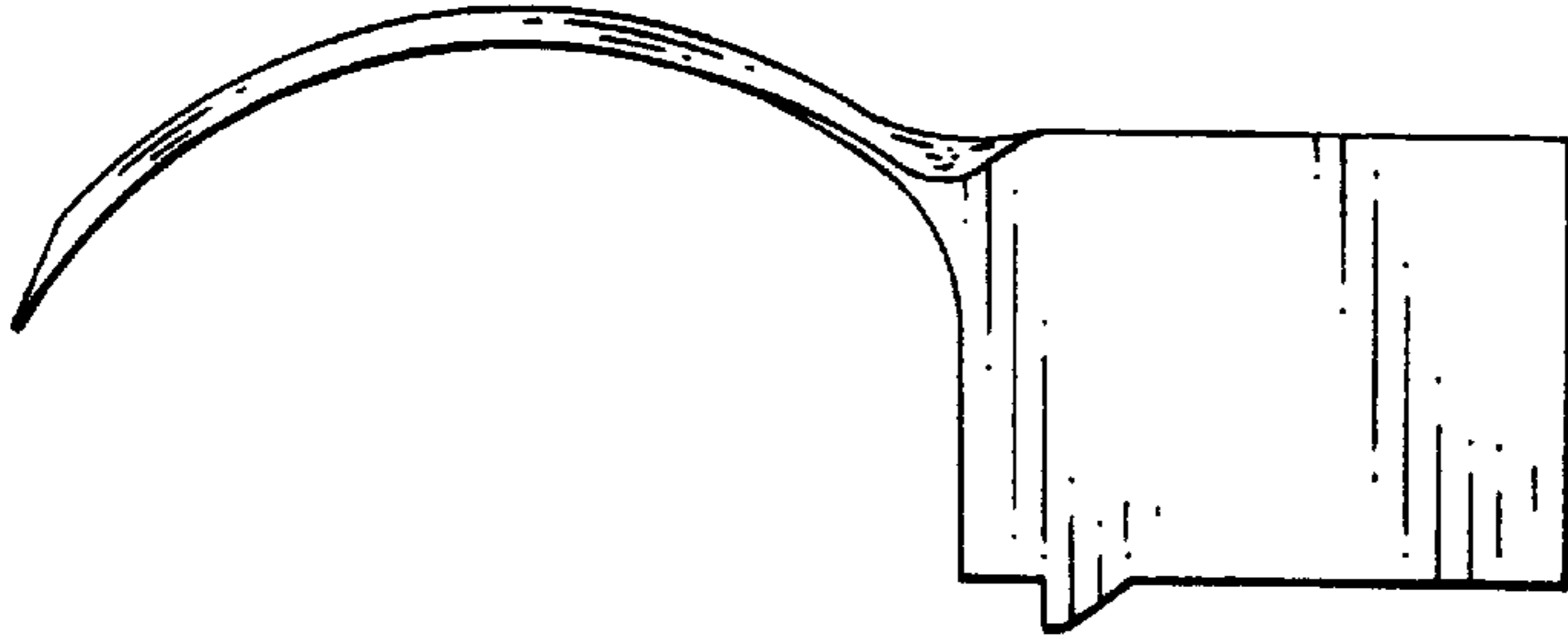

FIG. 2

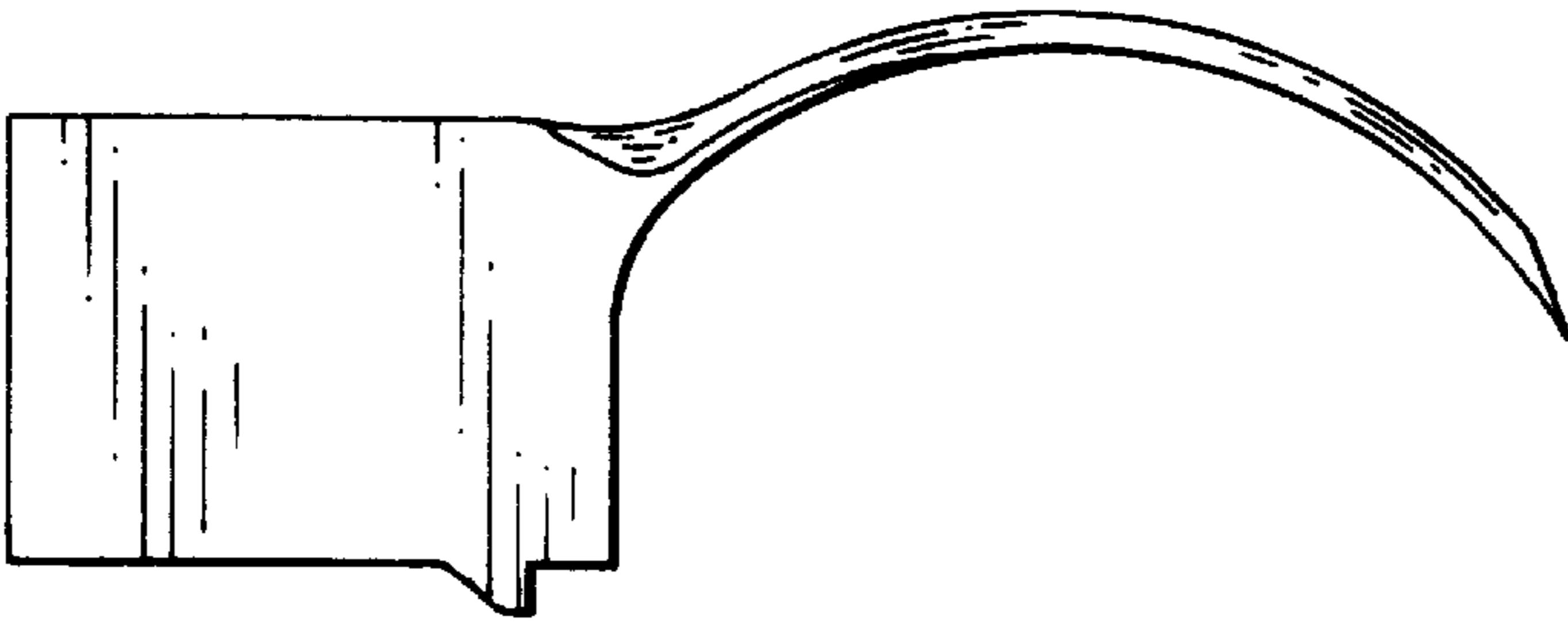

FIG. 3

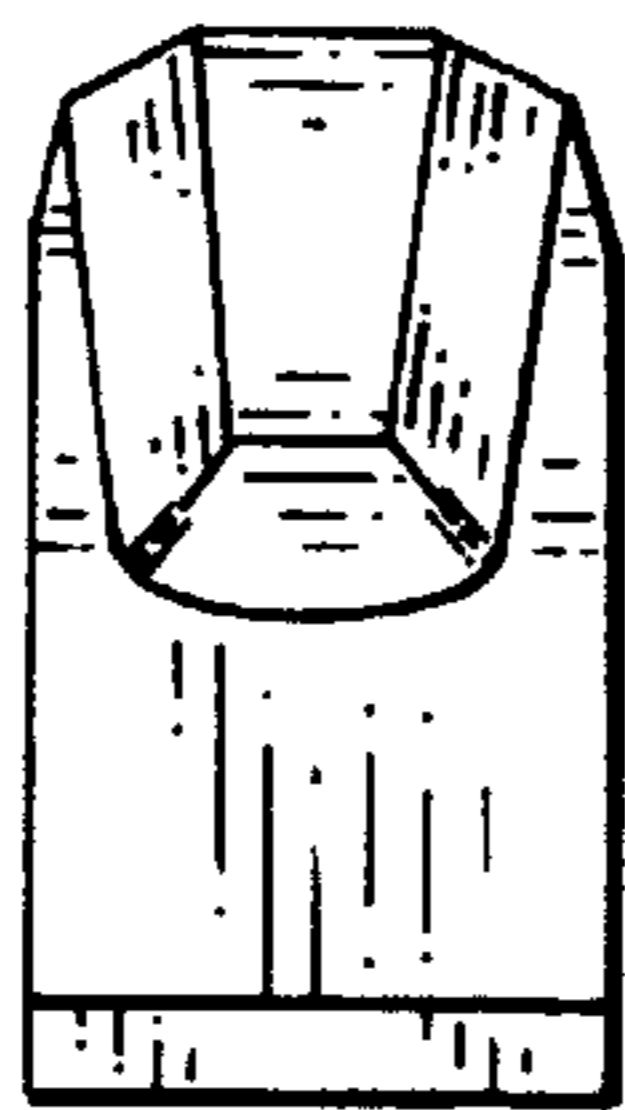

FIG. 4

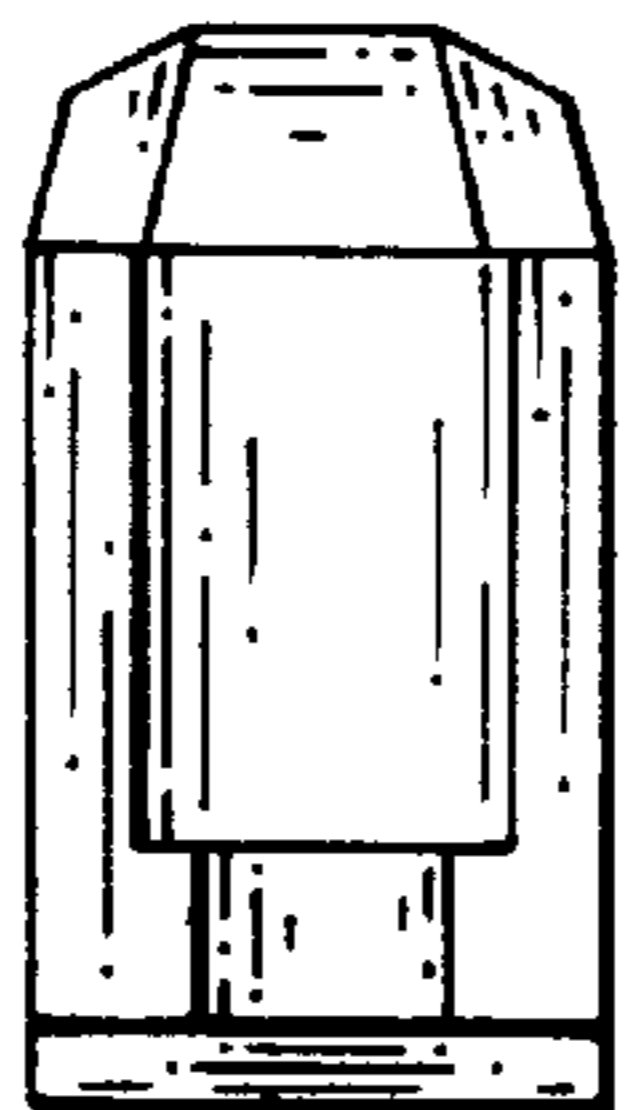

FIG. 5

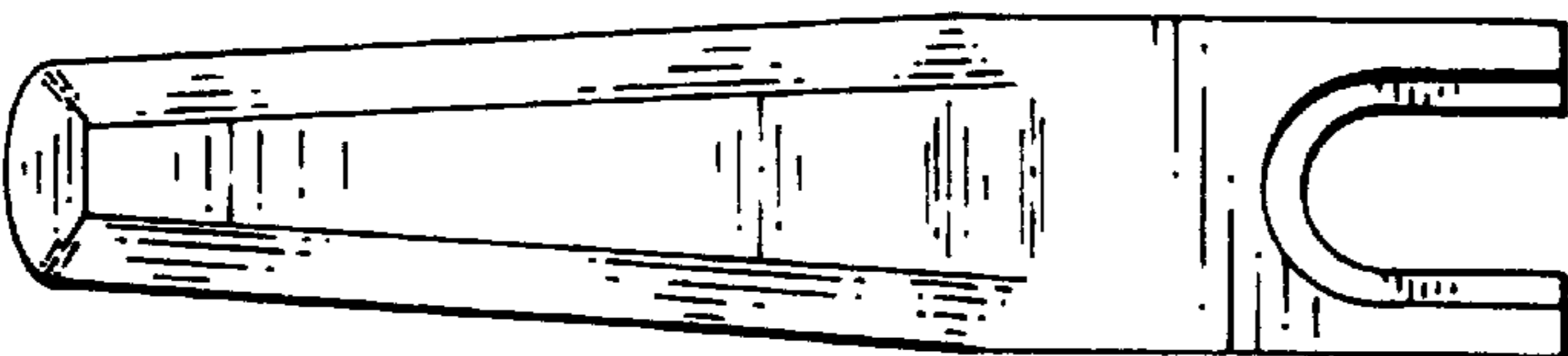

FIG. 6

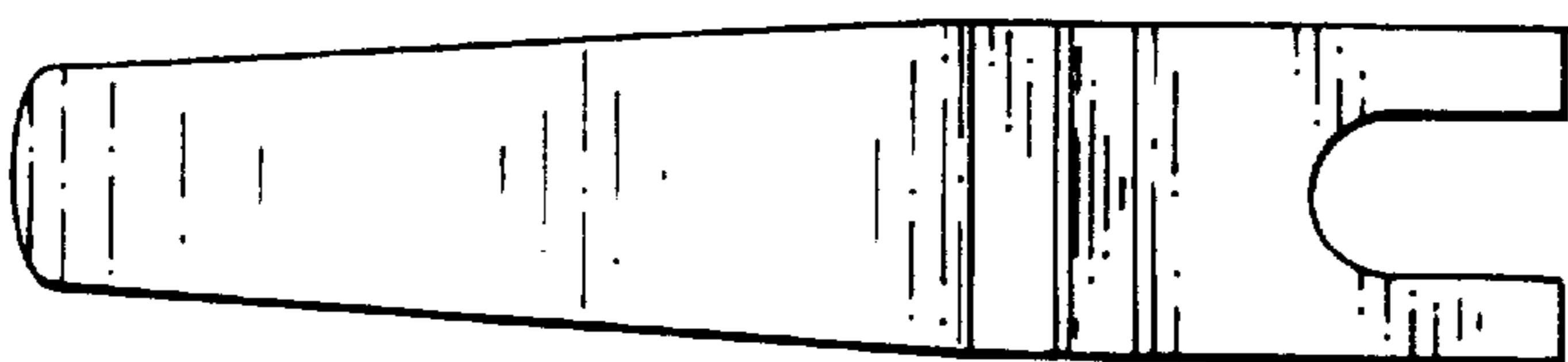

FIG. 7

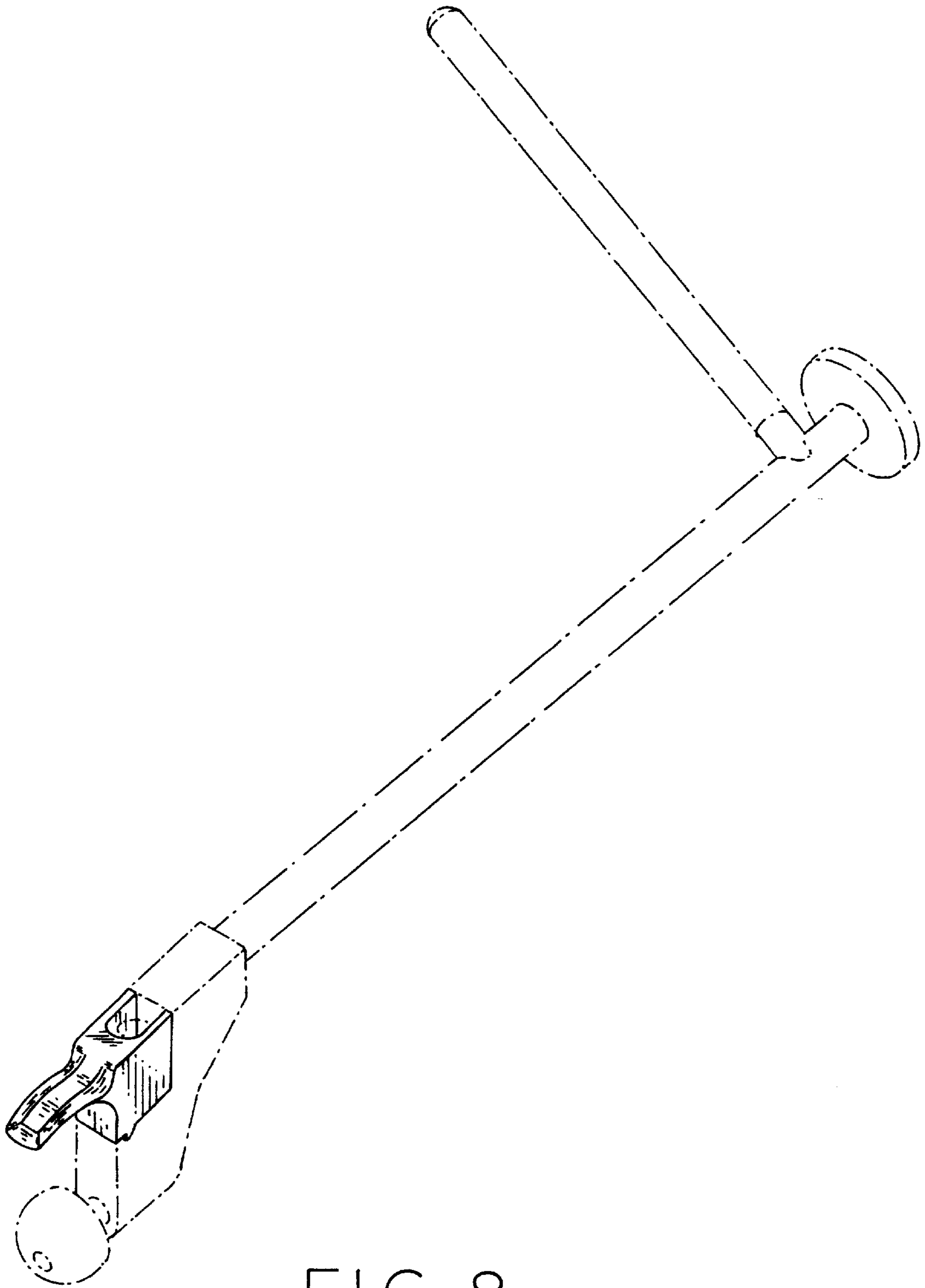

FIG. 8

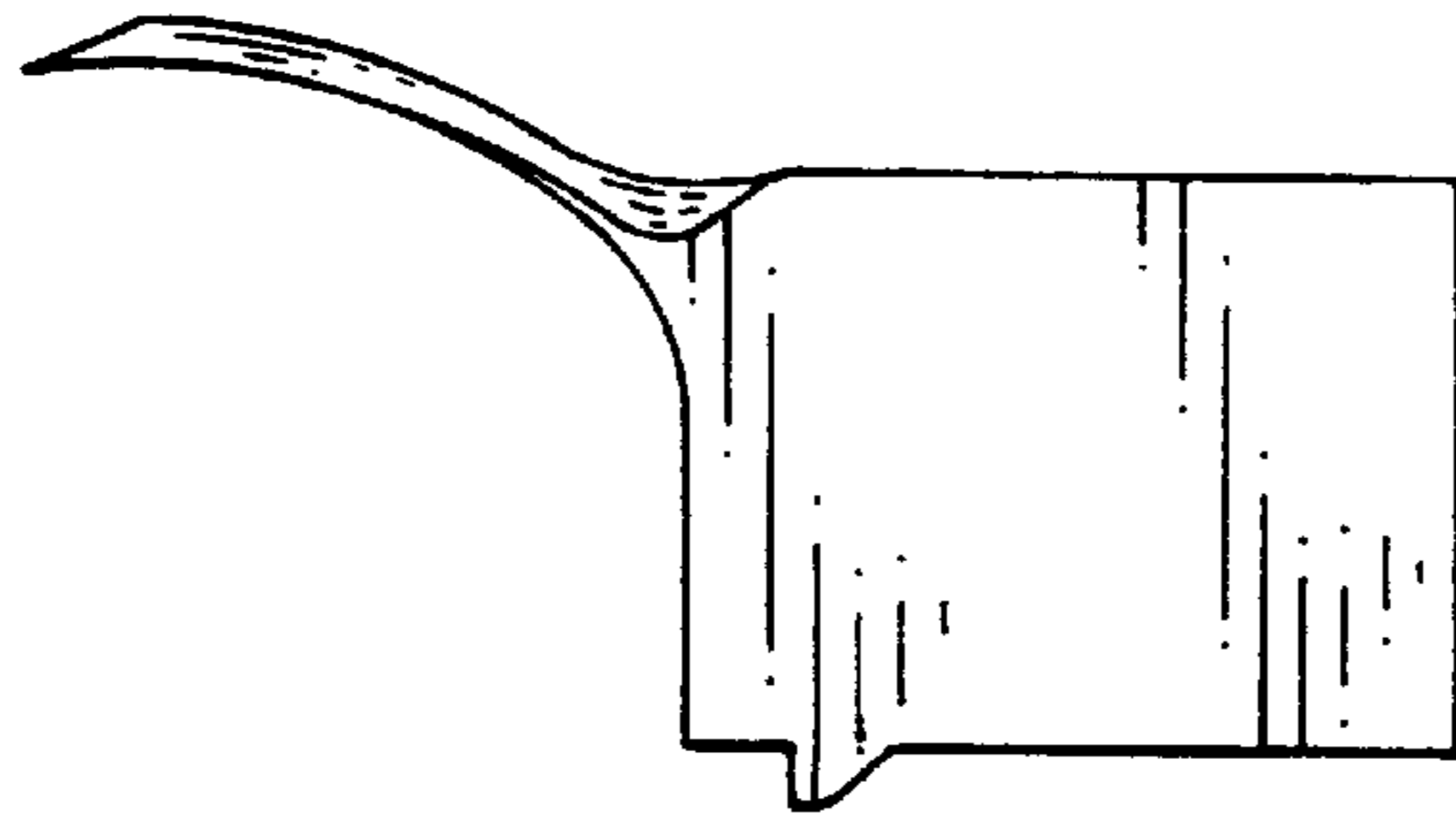

FIG. 9

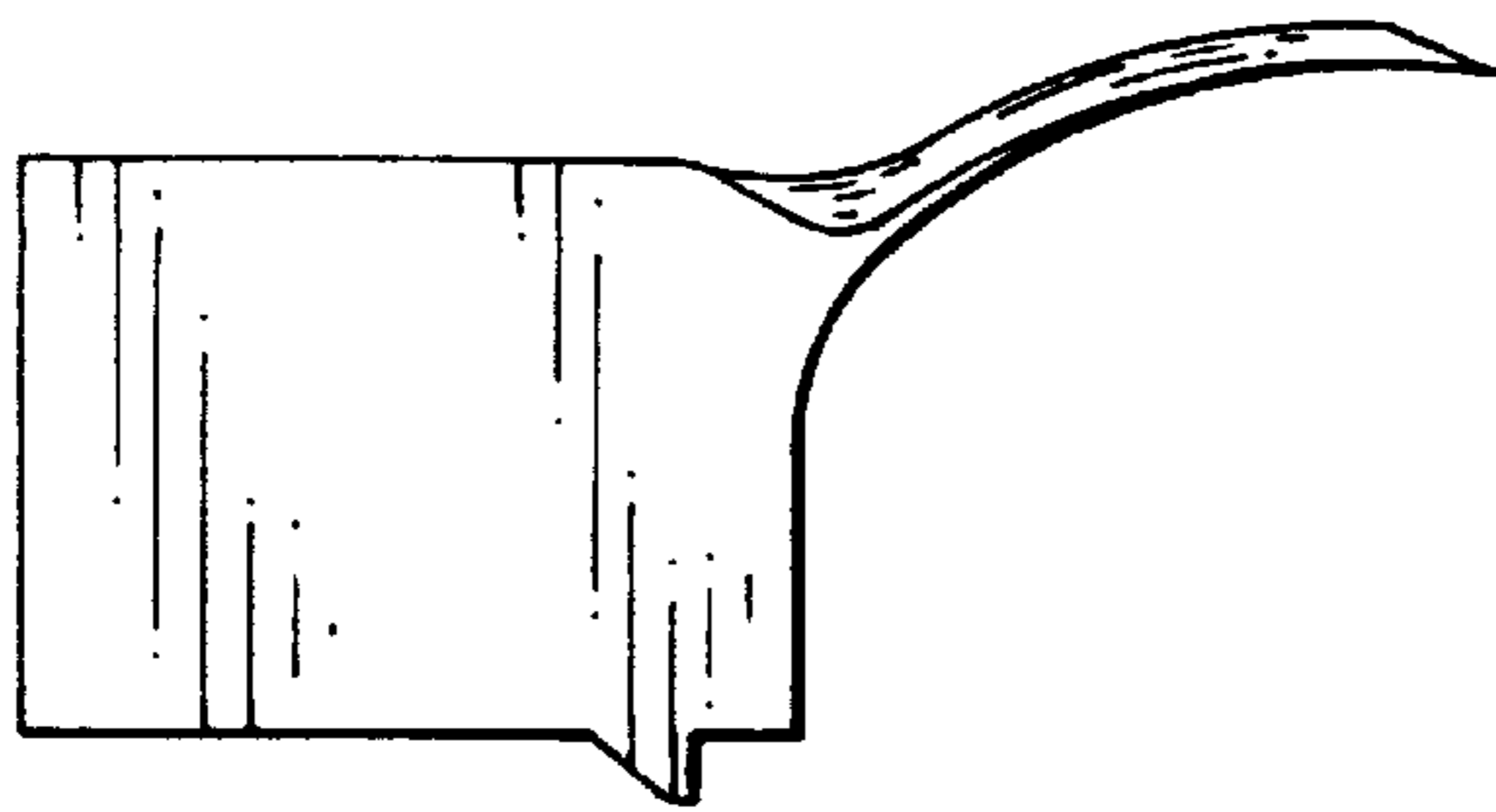

FIG. 10

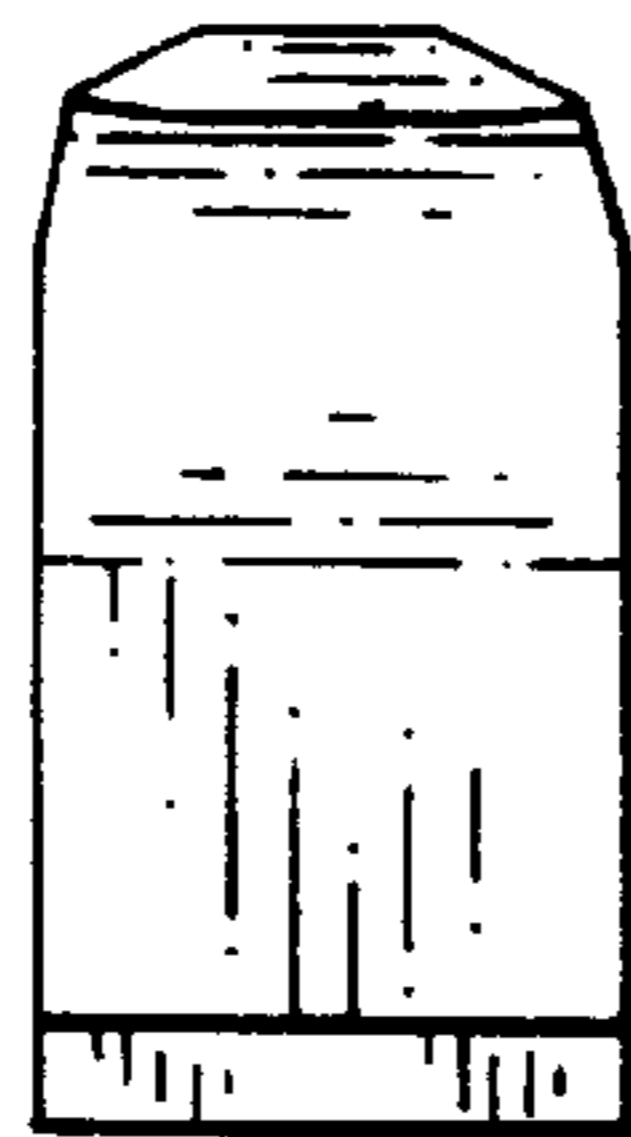

FIG. 11

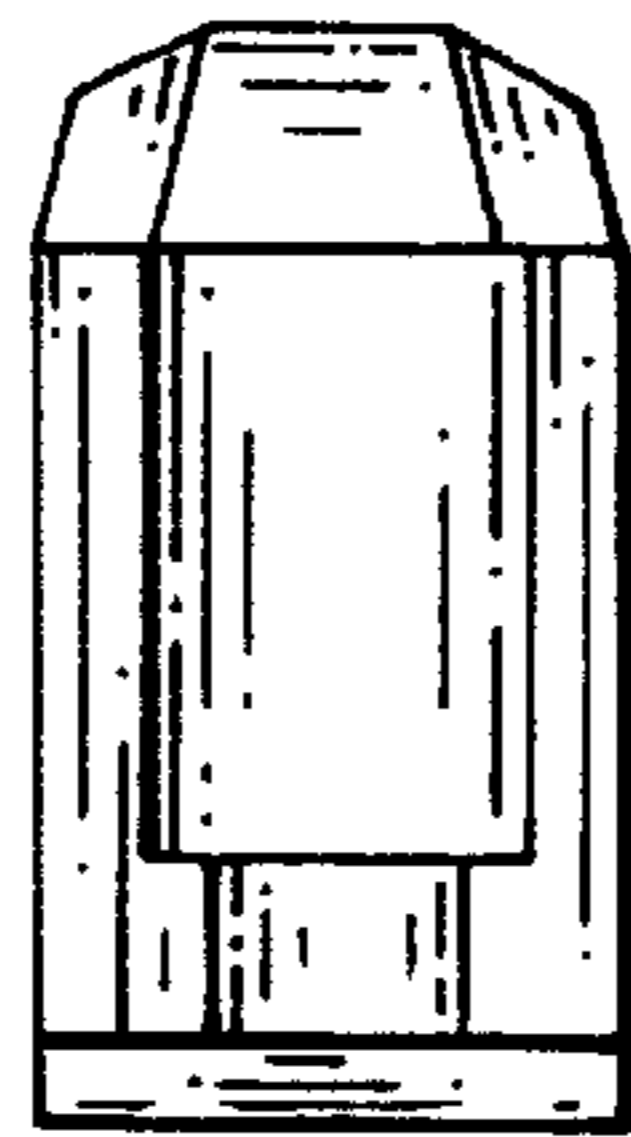

FIG. 12

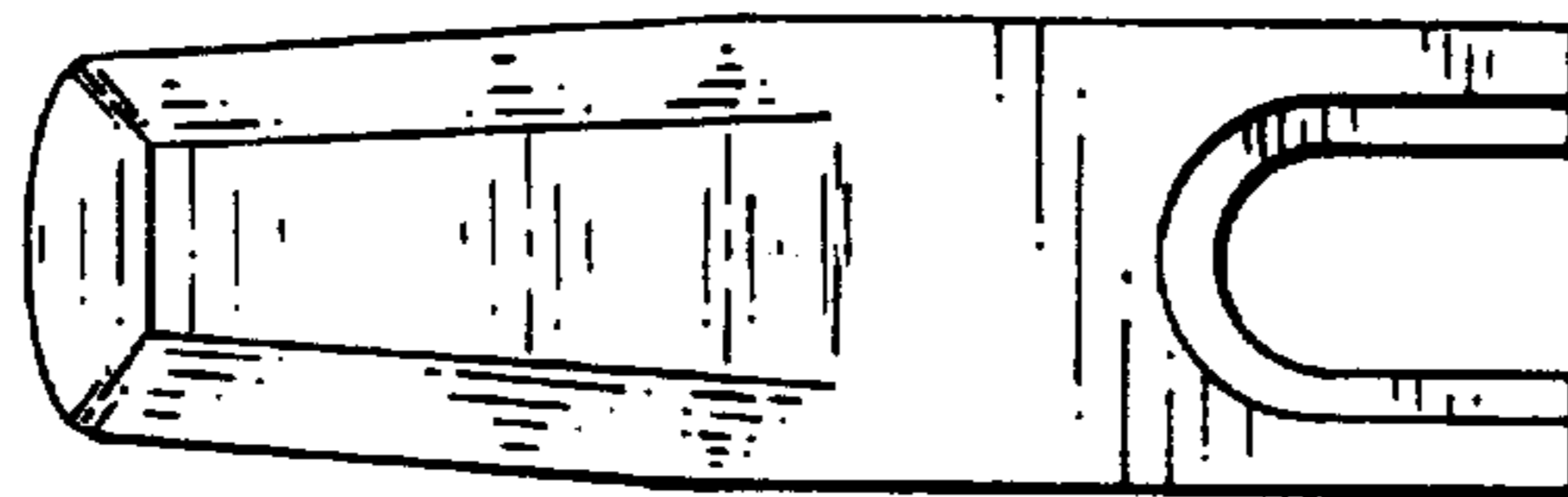

FIG. 13

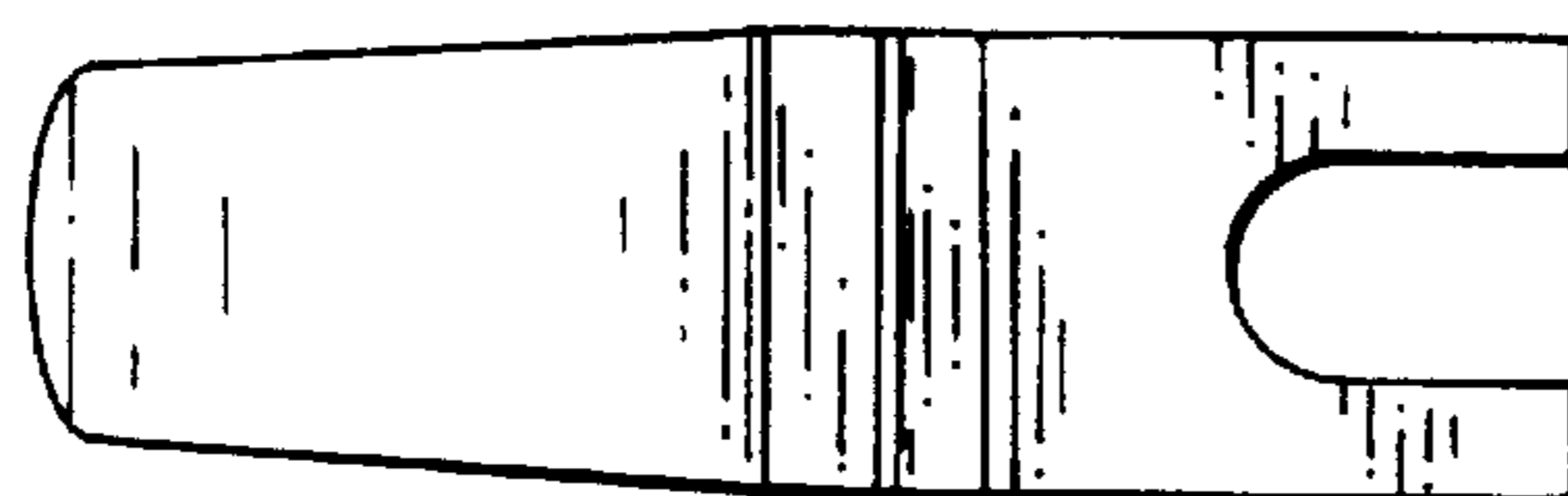

FIG. 14