



US00D450829B1

(12) **United States Design Patent**
Bothe et al.

(10) **Patent No.:** **US D450,829 S**

(45) **Date of Patent:** **** Nov. 20, 2001**

(54) **RANGE HOOD**

(75) Inventors: **Danny W. Bothe**, Watertown; **Brian R. Wellnitz**, Grafton; **David H. Roland**, Cedarburg; **Brett Vladika**, Milwaukee, all of WI (US)

(73) Assignee: **Broan-Nutone LLC**, Hartford, WI (US)

(**) Term: **14 Years**

(21) Appl. No.: **29/119,202**

(22) Filed: **Feb. 24, 2000**

(51) **LOC (7) Cl.** **23-04**

(52) **U.S. Cl.** **D23/372**

(58) **Field of Search** D23/372; 126/299 R,
126/299 D

(56) **References Cited**

U.S. PATENT DOCUMENTS

- D. 315,204 * 3/1991 Fleming et al. 126/299 D
- D. 375,351 * 11/1996 Conforti 126/299 D
- 5,027,790 * 7/1991 Chern 126/299 D
- 5,363,837 * 11/1994 Jang 126/299 D

* cited by examiner

Primary Examiner—Lisa Lichtenstein

(74) *Attorney, Agent, or Firm*—Michael Best & Friedrich LLP

(57) **CLAIM**

The ornamental design of a range hood, as shown and described.

DESCRIPTION

FIG. 1 is a perspective view of a range hood embodying the present invention;

FIG. 2 is a front view of the range hood;

FIG. 3 is a right side view thereof, with the opposite side being a mirror image;

FIG. 4 is a top view thereof;

FIG. 5 is a bottom view thereof; and,

FIG. 6 is a back view of the range hood.

The broken line showing of environmental structure in FIGS. 1–6 is for illustrative purposes only and forms no part of the claimed design.

1 Claim, 3 Drawing Sheets

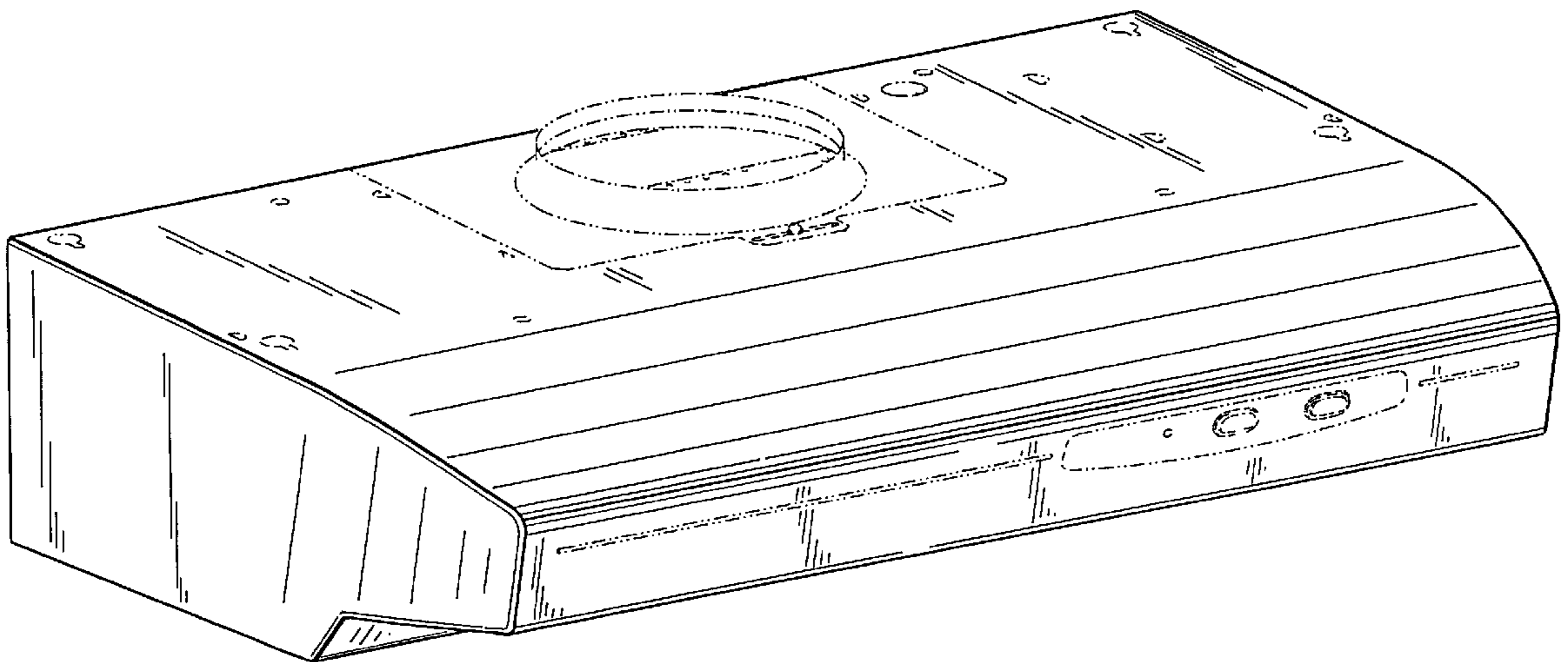

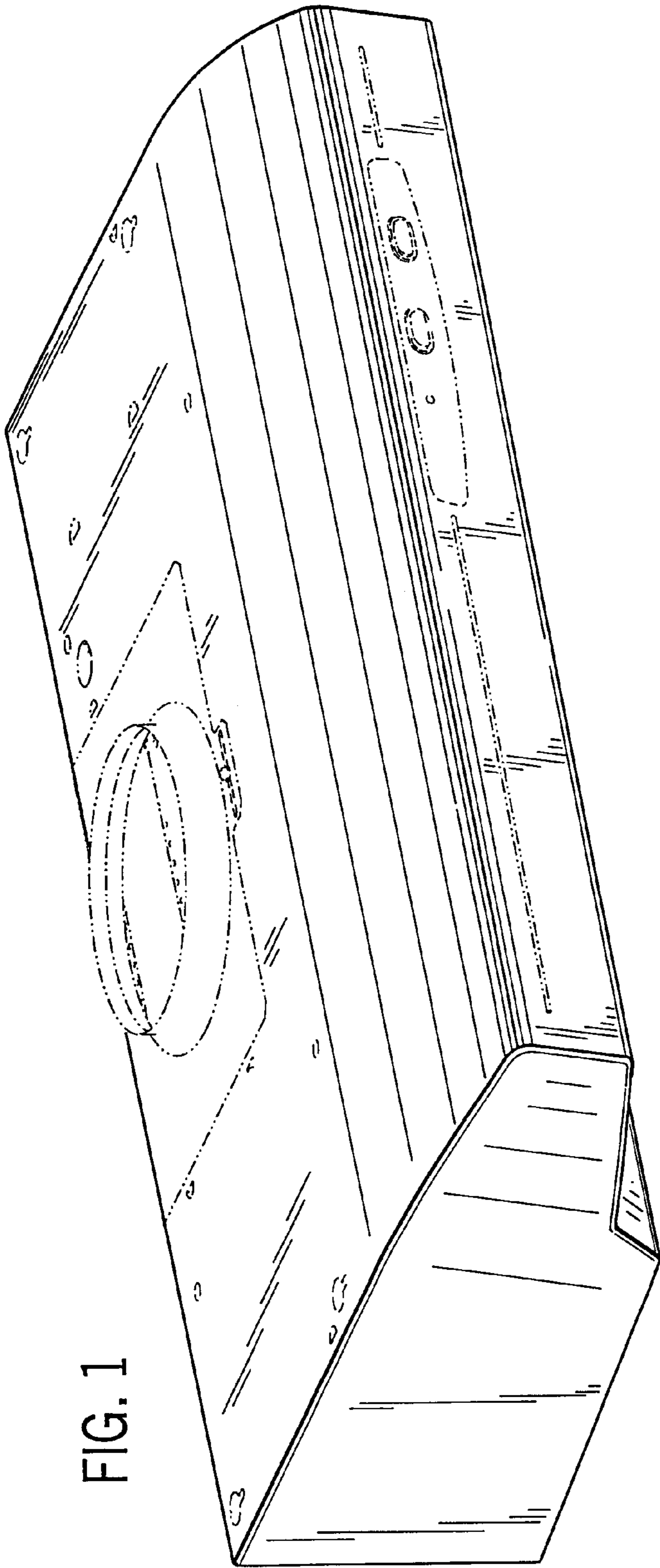

FIG. 1

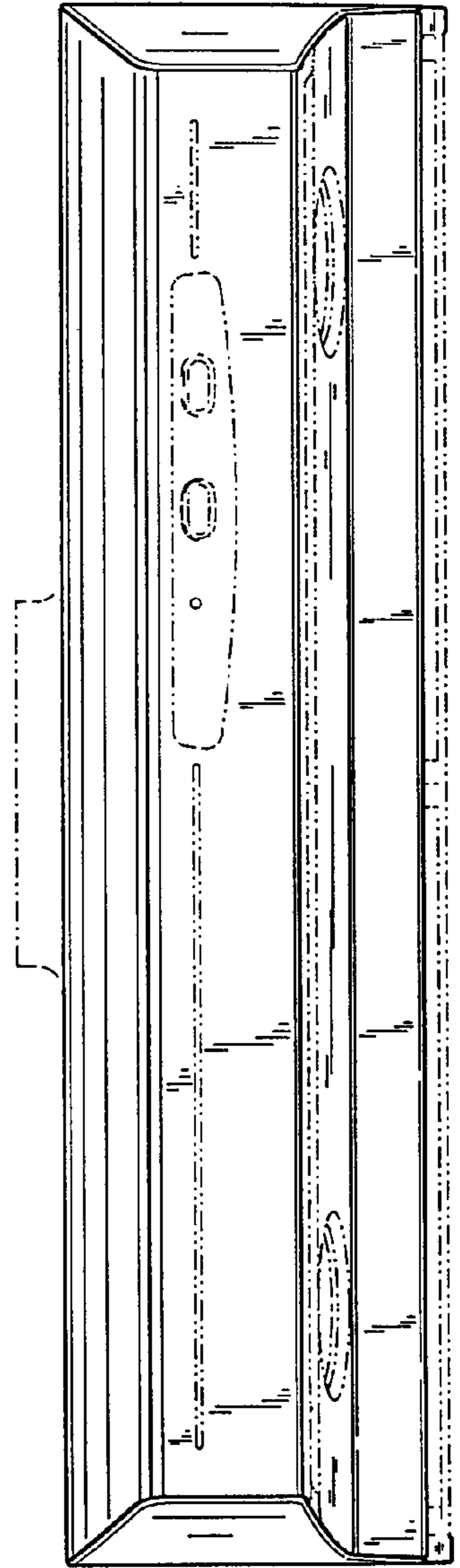

FIG. 2

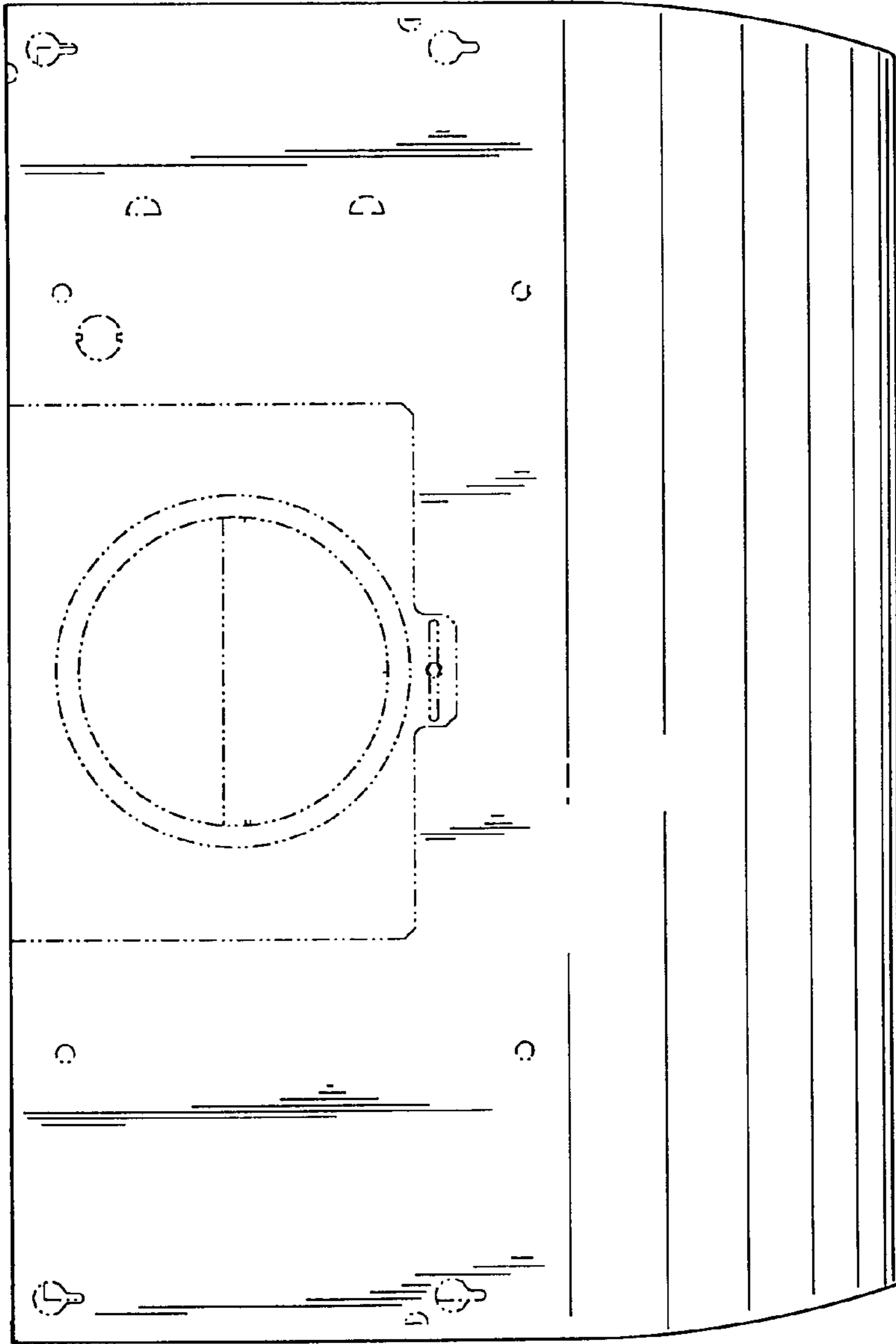

FIG. 4

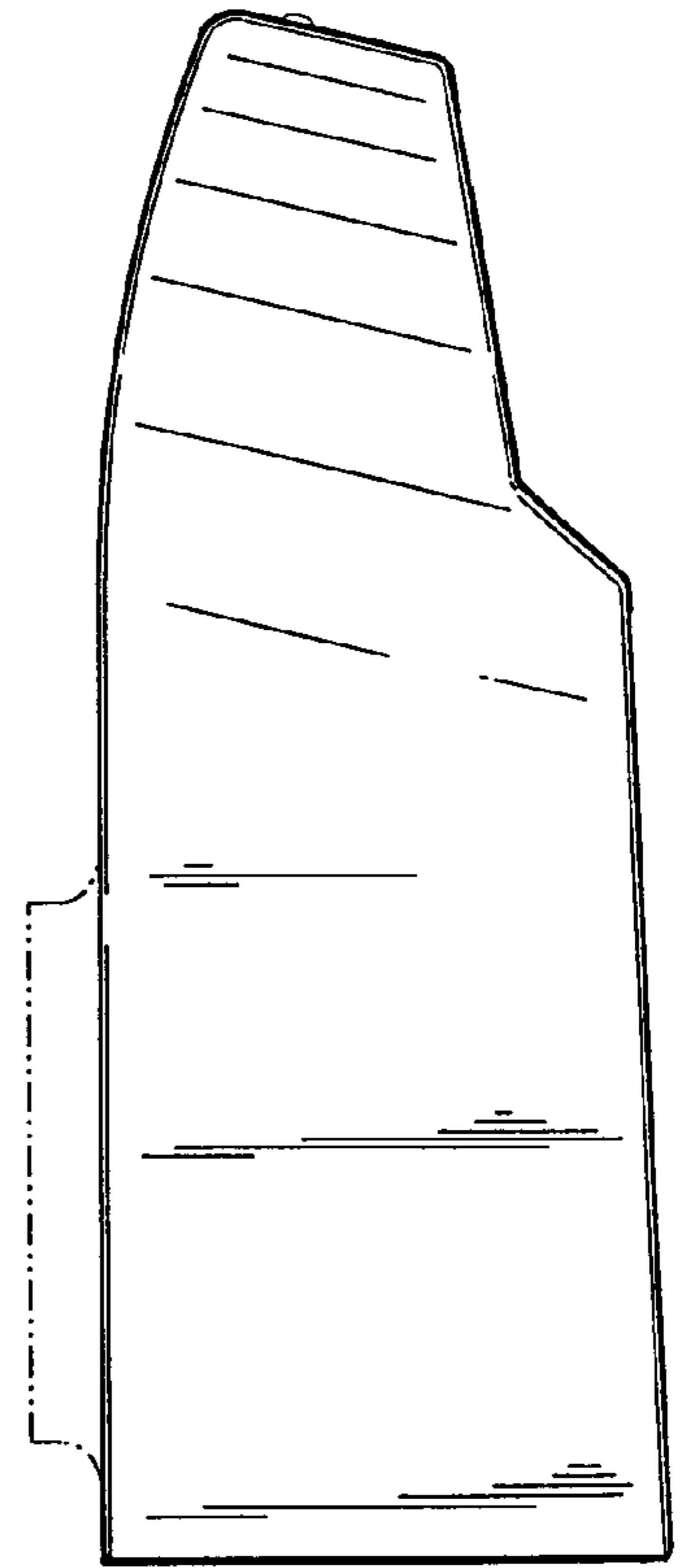

FIG. 3

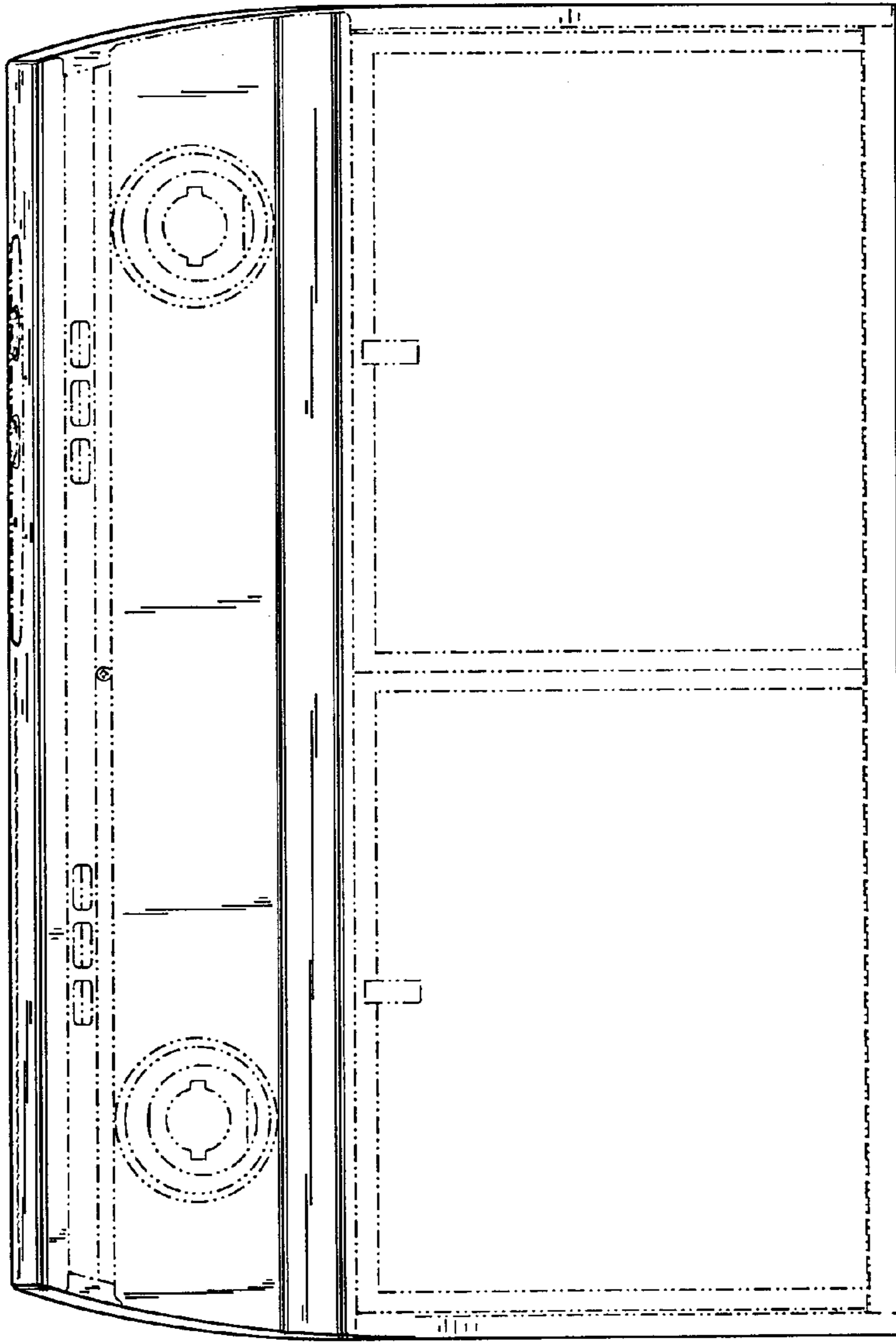

FIG. 5

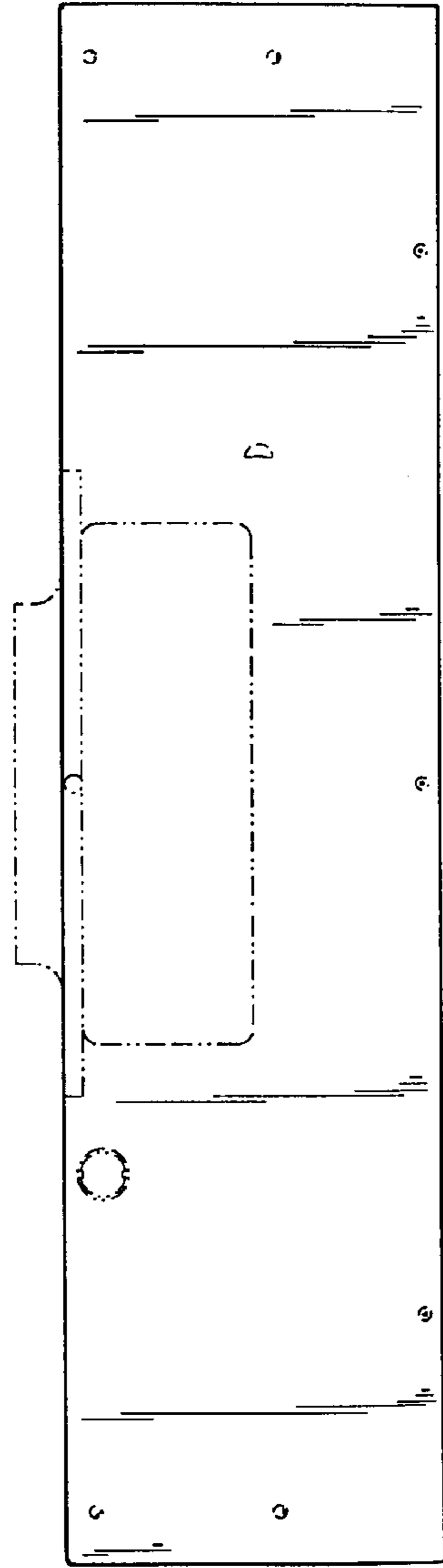

FIG. 6