



US00D450768B1

(12) **United States Design Patent**
Keda

(10) **Patent No.:** **US D450,768 S**

(45) **Date of Patent:** **** Nov. 20, 2001**

(54) **WRITING INSTRUMENT**

(75) Inventor: **Tadashi Keda**, Kawagoe (JP)

(73) Assignee: **Kotobuki & Co., Ltd.**, Kyoto (JP)

(**) Term: **14 Years**

(21) Appl. No.: **29/135,932**

(22) Filed: **Jan. 23, 2001**

(30) **Foreign Application Priority Data**

Jul. 24, 2000 (JP) 12-023543

(51) **LOC (7) Cl.** **19-06**

(52) **U.S. Cl.** **D19/48; D19/49; D19/56**

(58) **Field of Search** D19/35, 36, 41-51,
D19/53-58, 81-85; 401/49-52, 99, 100-106,
110-117, 209, 195, 6, 7, 88

(56) **References Cited**

U.S. PATENT DOCUMENTS

D. 155,429	*	10/1949	Kahn	D19/48
D. 155,806	*	11/1949	Kahn	D19/48
D. 177,560	*	5/1956	Ensign et al.	D19/49
D. 190,262	*	5/1961	Schier	D19/49
D. 213,341	*	2/1969	Fields	D19/49
D. 240,817	*	8/1976	Funahashi	D19/48
D. 397,723	*	9/1998	Izushima	D19/49
D. 423,578	*	4/2000	Izushima	D19/48

* cited by examiner

Primary Examiner—Martie K. Holtje

(74) *Attorney, Agent, or Firm*—McGinn & Gibb, PLLC

(57) **CLAIM**

The ornamental design for a writing instrument, as shown and described.

DESCRIPTION

FIG. 1 is a front elevational view of the writing instrument according to the present invention;

FIG. 2 is a right side elevational view of the writing instrument of FIG. 1, the left side being a mirror image of the right side;

FIG. 3 is a rear elevational view of the writing instrument of FIG. 1;

FIG. 4 is a top plan view of the writing instrument of FIG. 1;

FIG. 5 is a bottom plan view of the writing instrument of FIG. 1;

FIG. 6 is a perspective view of the writing instrument of FIG. 1, with a writing tip of the writing instrument being projected and with an eraser being extended;

FIG. 7 is an enlarged sectional view of the writing instrument of FIG. 1, taken on a plane indicated in FIG. 1 by a line 7—7, in which an internal mechanism of the writing instrument is removed for clarity of illustration;

FIG. 8 is an enlarged sectional view of the writing instrument of FIG. 1, taken on a plane indicated in FIG. 1 by a line 8—8, in which the internal mechanism of the writing instrument is removed for clarity of illustration;

FIG. 9 is an enlarged sectional view of the writing instrument of FIG. 1, taken on a plane indicated in FIG. 1 by a line 9—9, in which the internal mechanism of the writing instrument is removed for clarity of illustration; and,

FIG. 10 is an enlarged sectional view of the writing instrument of FIG. 1, taken on a plane indicated in FIG. 1 by a line 10—10, in which the internal mechanism of the writing instrument is removed for clarity of illustration.

1 Claim, 3 Drawing Sheets

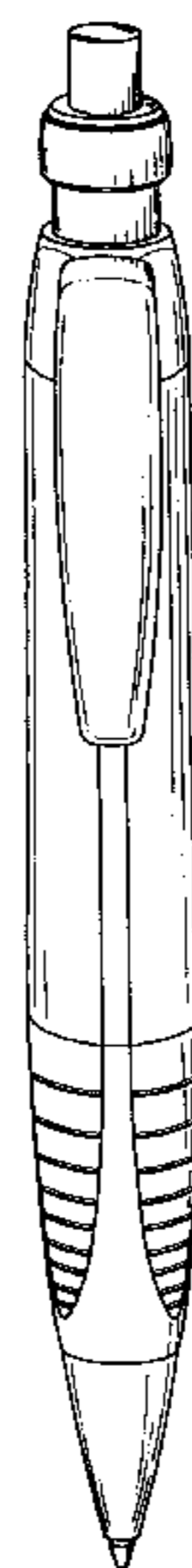

FIG. 2

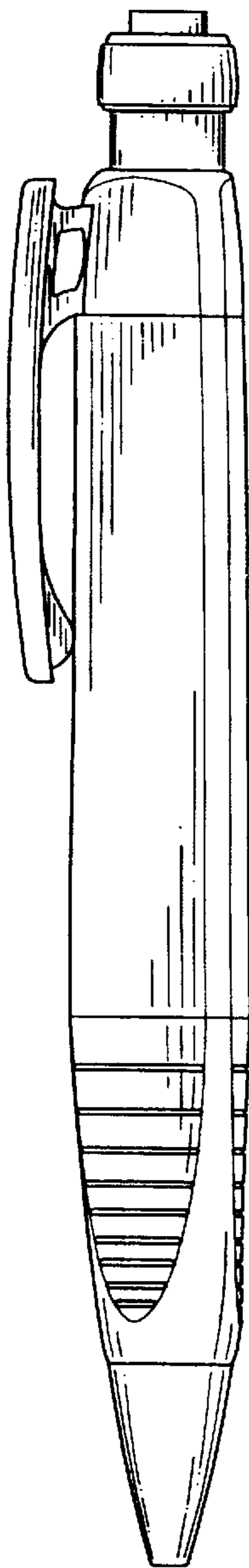

FIG. 1

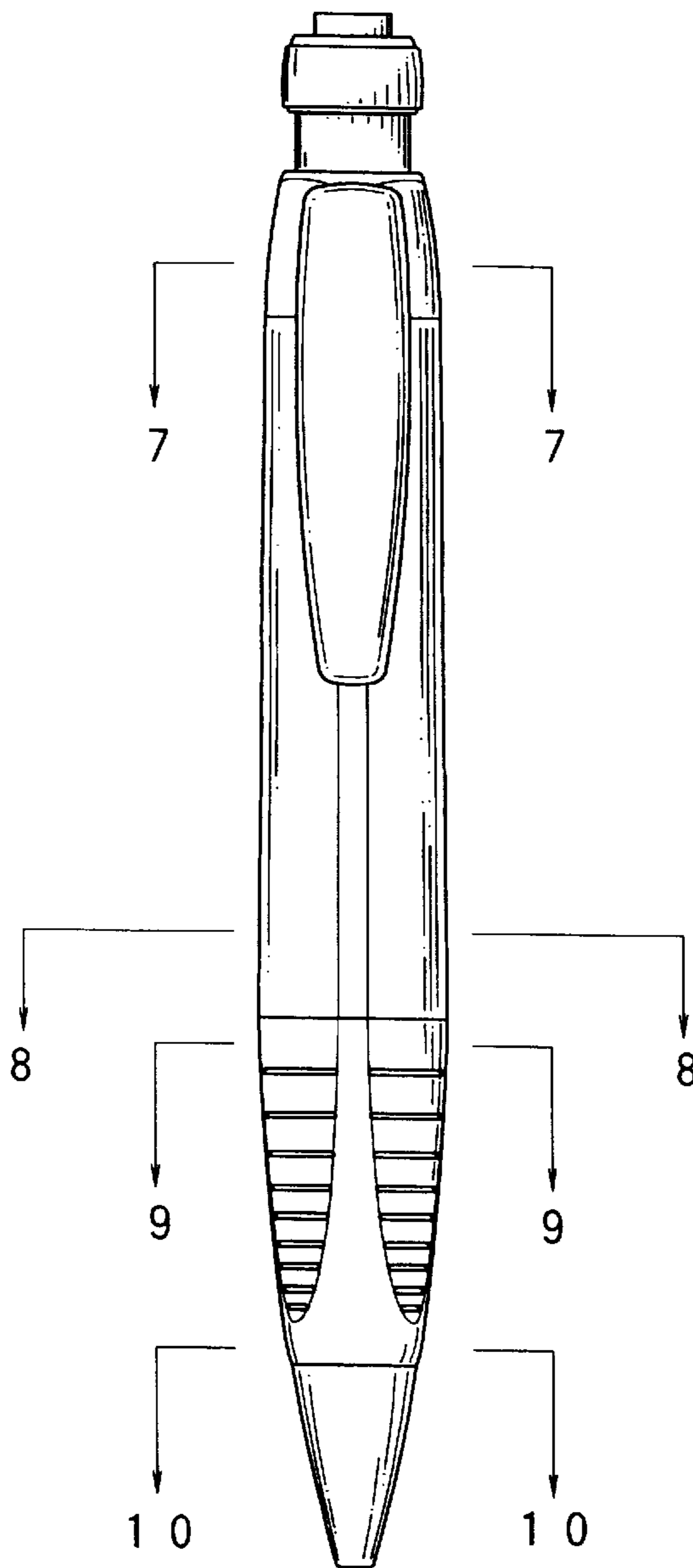

FIG. 3

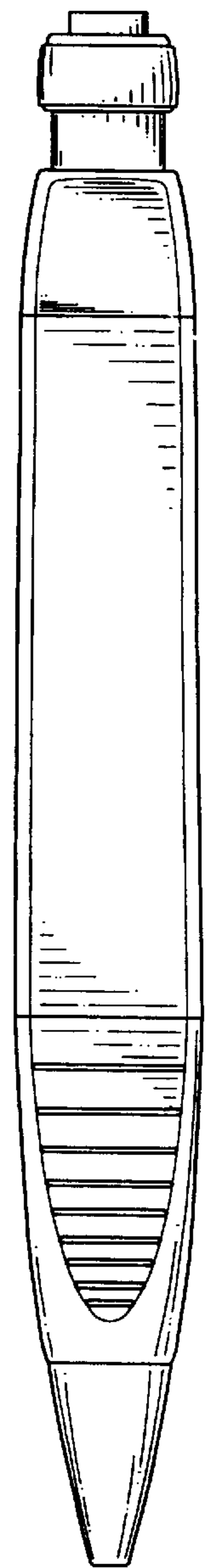

FIG. 6

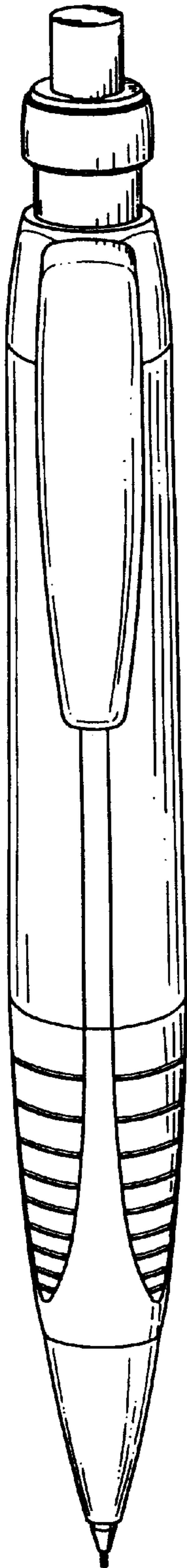

FIG. 4

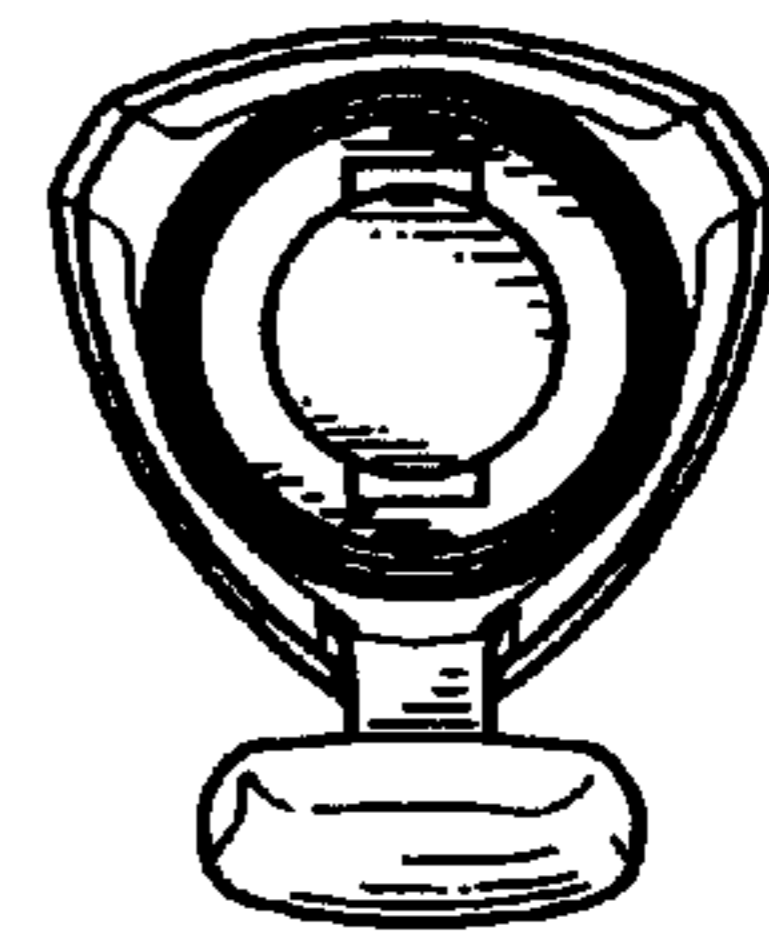

FIG. 5

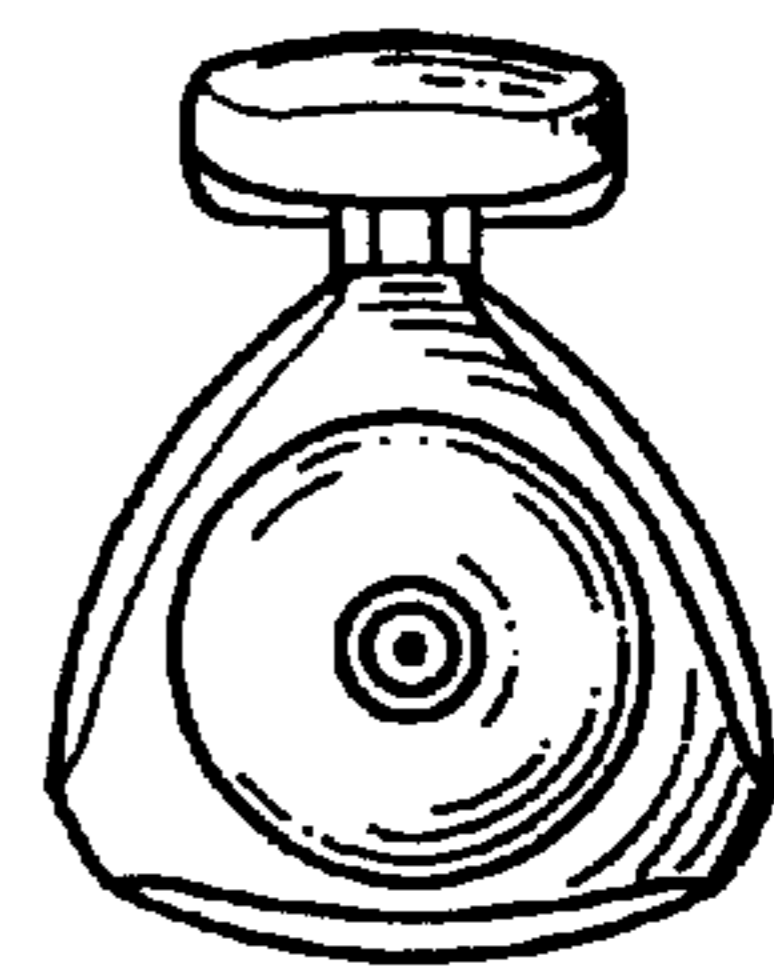

FIG. 9

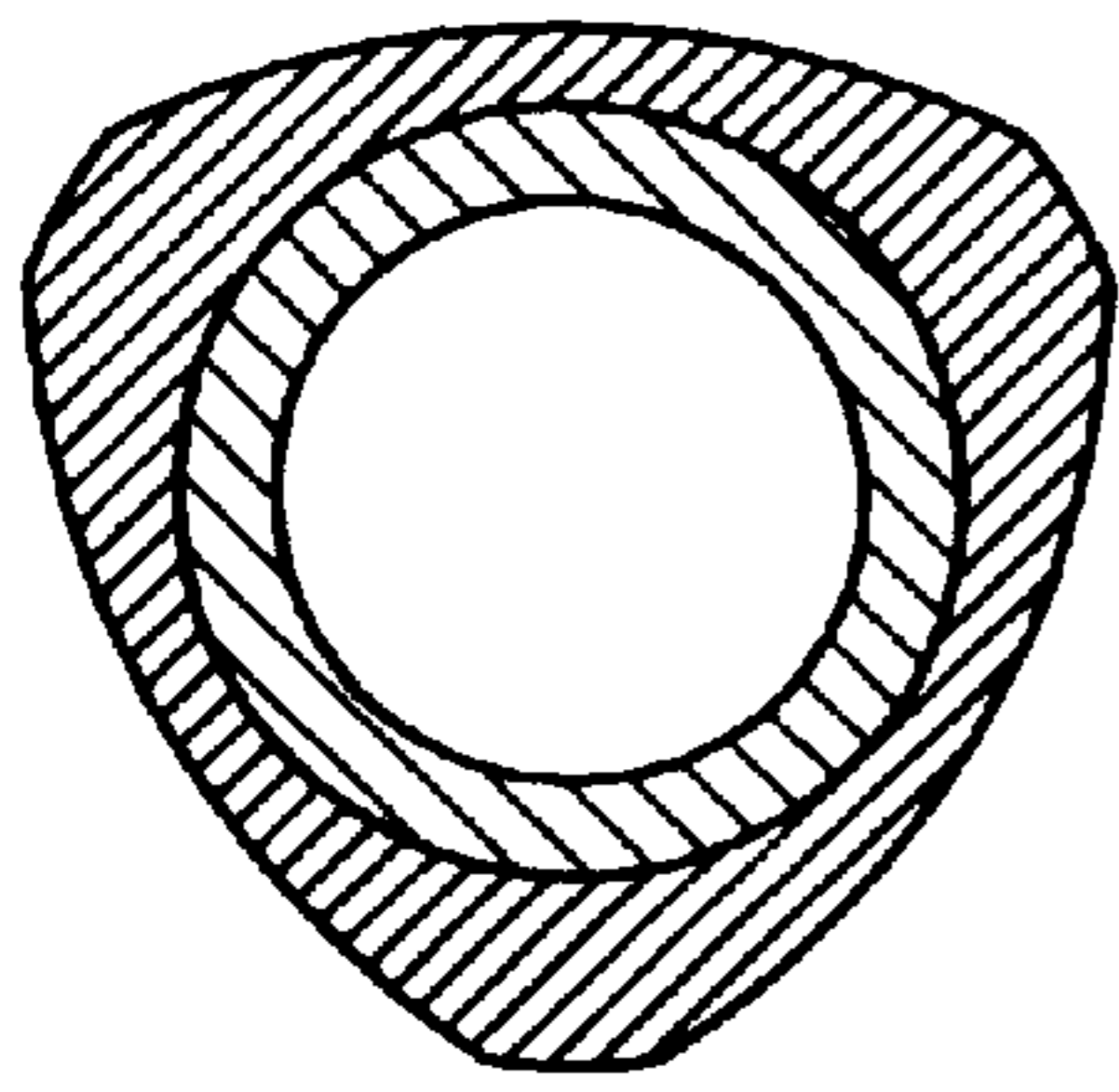

FIG. 7

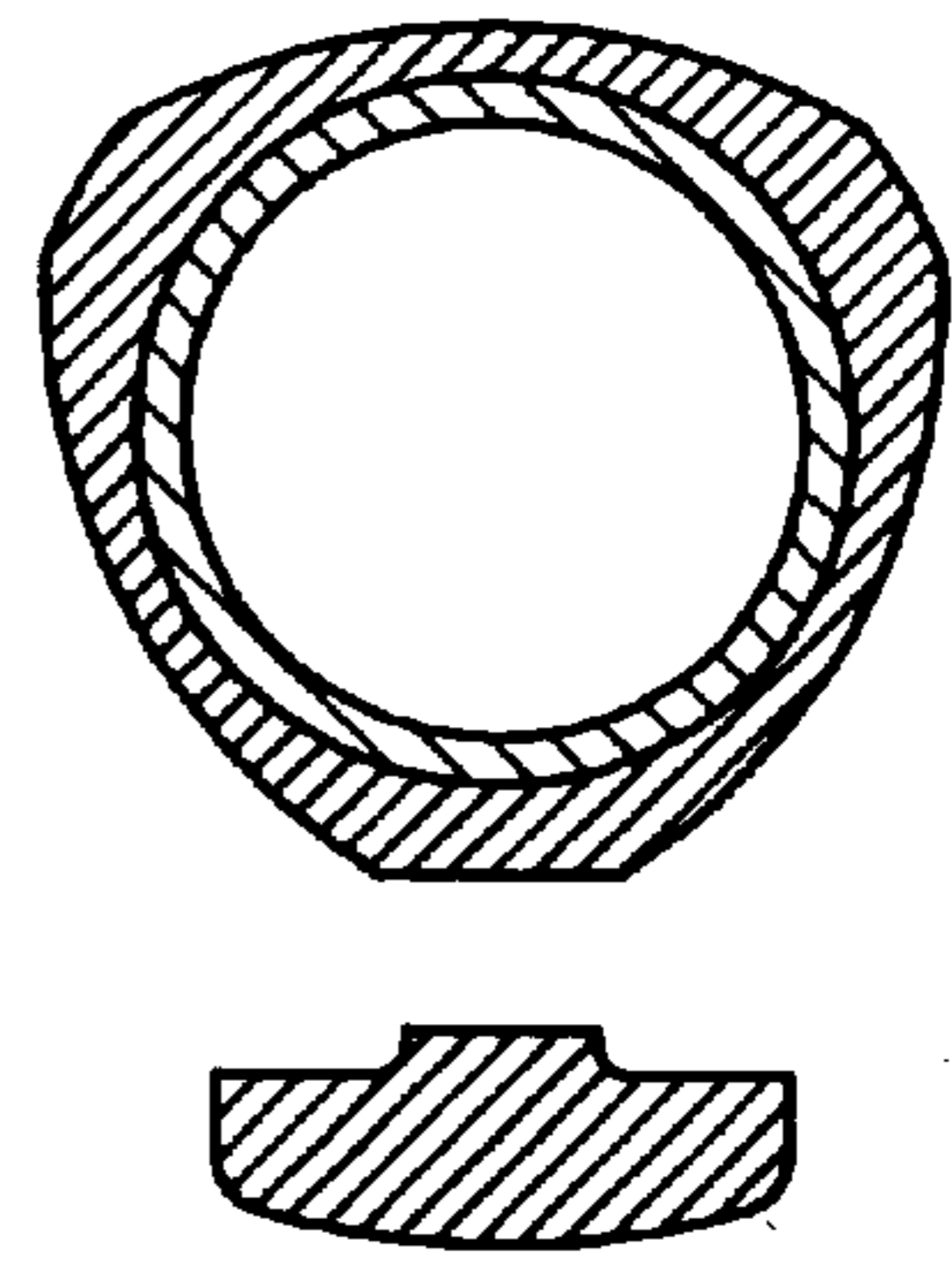

FIG. 10

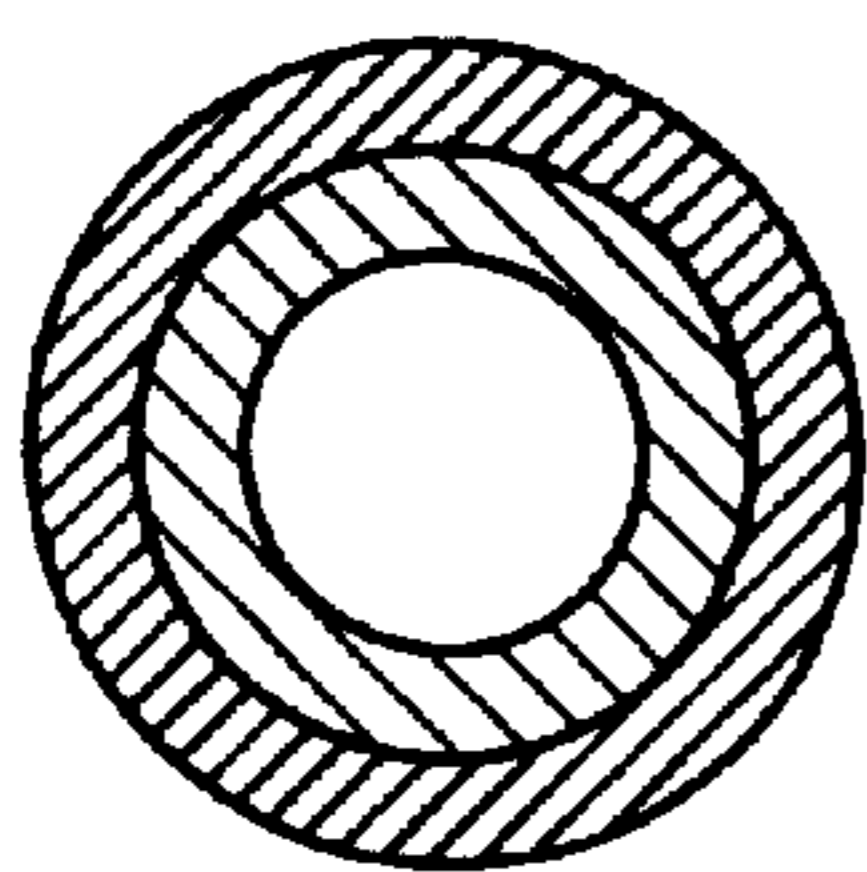

FIG. 8

