



US00D450753B1

(12) **United States Design Patent**
Nomura et al.

(10) **Patent No.:** **US D450,753 S**

(45) **Date of Patent:** **** Nov. 20, 2001**

(54) **GATHERER FOR COPYING MACHINE**

D. 423,041 * 4/2000 Takeuchi D18/46
D. 438,239 * 2/2001 Agata D18/47

(75) Inventors: **Kanae Nomura**, Tokyo; **Masaaki Kabumoto**, Chiba; **Masahiro Kurita**, Kanagawa, all of (JP)

* cited by examiner

(73) Assignee: **Ricoh Company, Ltd.**, Tokyo (JP)

Primary Examiner—Caron D. Veynar
(74) *Attorney, Agent, or Firm*—Dickstein Shapiro Morin & Oshinsky LLP

(**) Term: **14 Years**

(57) **CLAIM**

(21) Appl. No.: **29/127,964**

The ornamental design for the gatherer for copying machine, as shown and described.

(22) Filed: **Aug. 15, 2000**

DESCRIPTION

(30) **Foreign Application Priority Data**

Feb. 23, 2000 (JP) 12-003425

(51) **LOC (7) Cl.** **18-99**

(52) **U.S. Cl.** **D18/47**

(58) **Field of Search** D18/46-49; 399/361, 399/405, 407, 411; 271/8.1, 3.14, 278

FIG. 1 is a front elevation of a gatherer for copying machine showing our new design;
FIG. 2 is a rear elevation thereof;
FIG. 3 is a top plan view thereof;
FIG. 4 is a bottom plan view thereof;
FIG. 5 is a left side elevation thereof;
FIG. 6 is a right side elevation thereof; and,
FIG. 7 is a top, front, and left side perspective view.
The broken lines shown are for illustrative purposes only and form no part of the claimed design.

(56) **References Cited**

U.S. PATENT DOCUMENTS

D. 421,044 * 2/2000 Komatsu D18/47

1 Claim, 4 Drawing Sheets

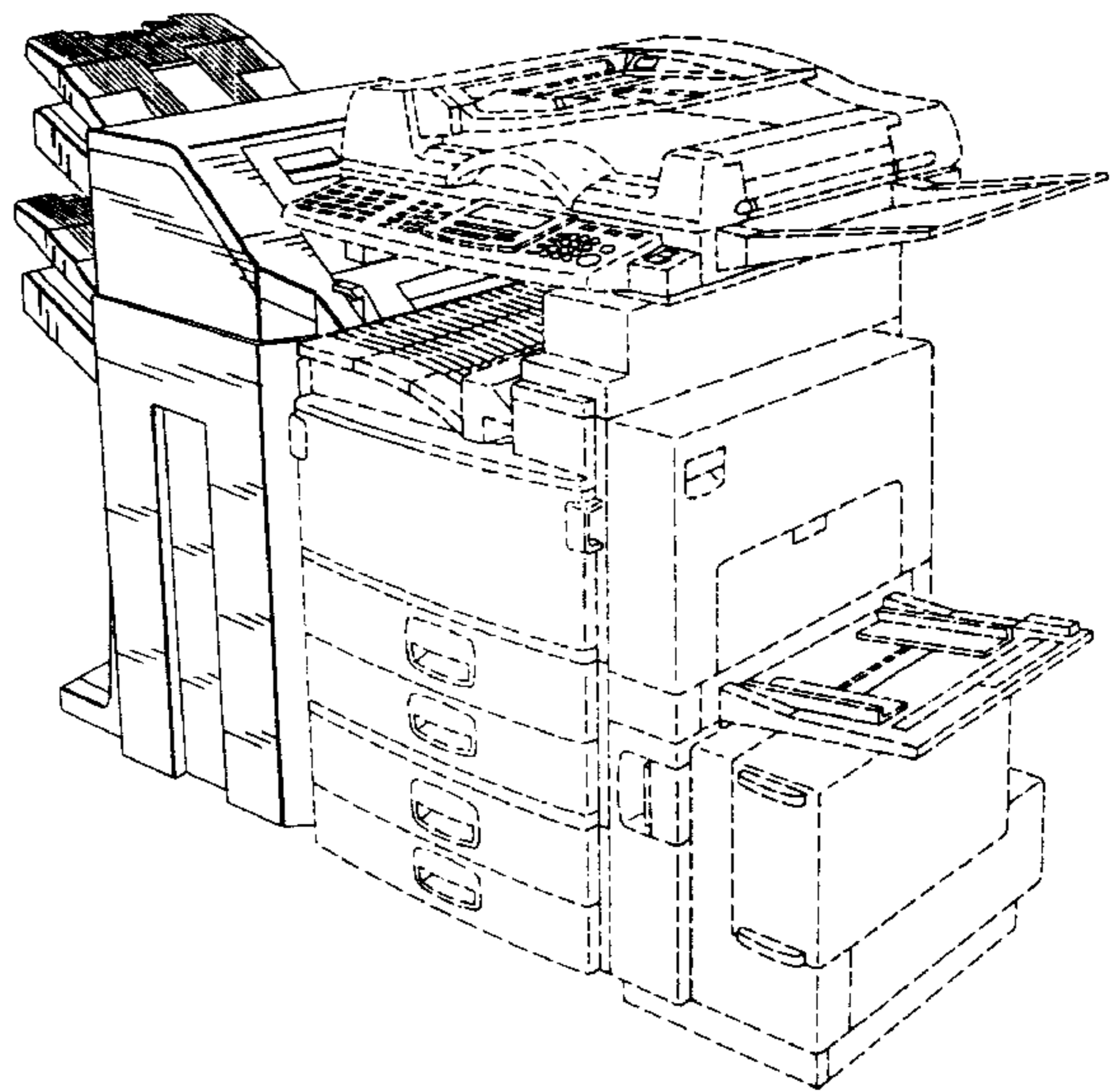
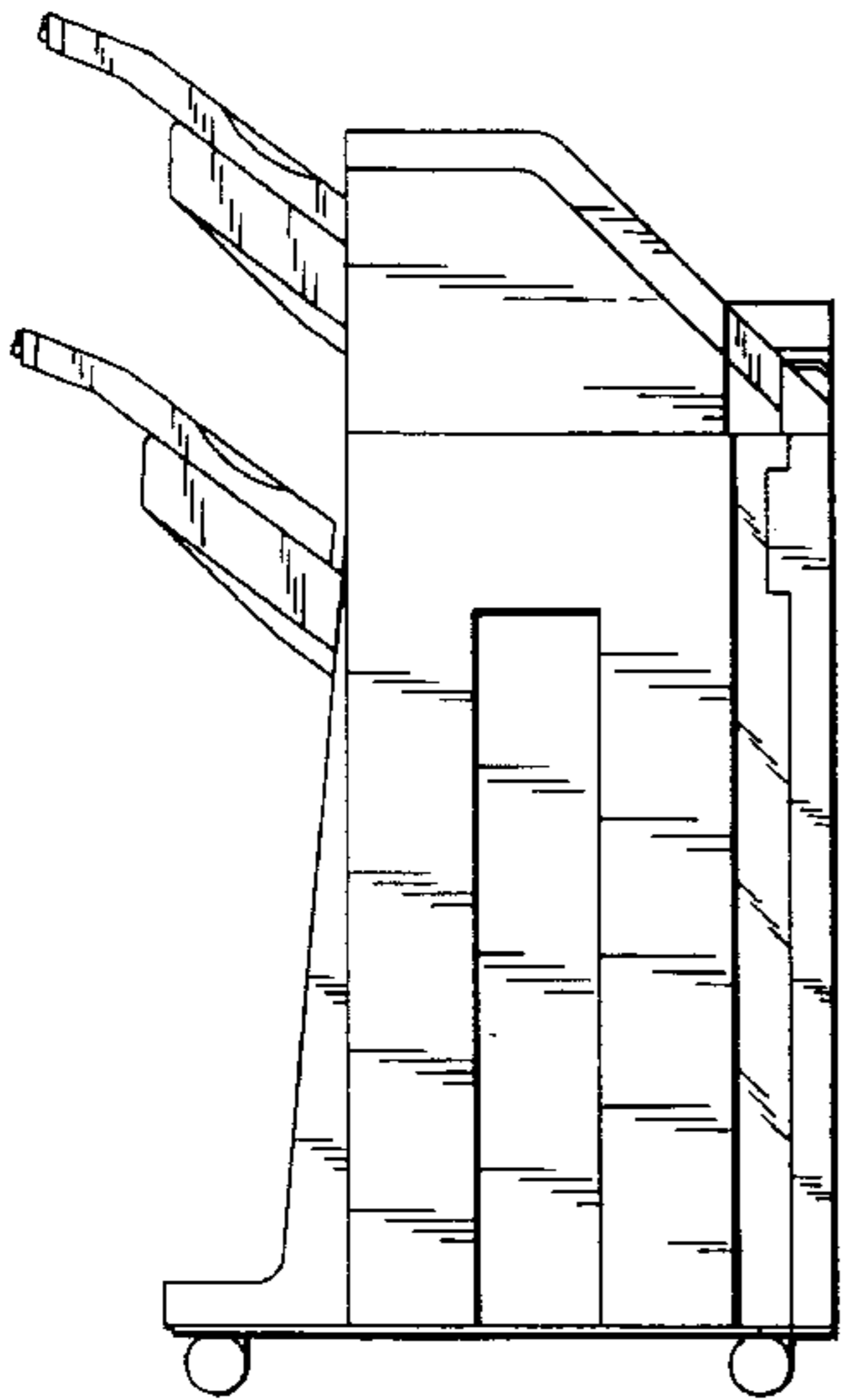

FIG. 1

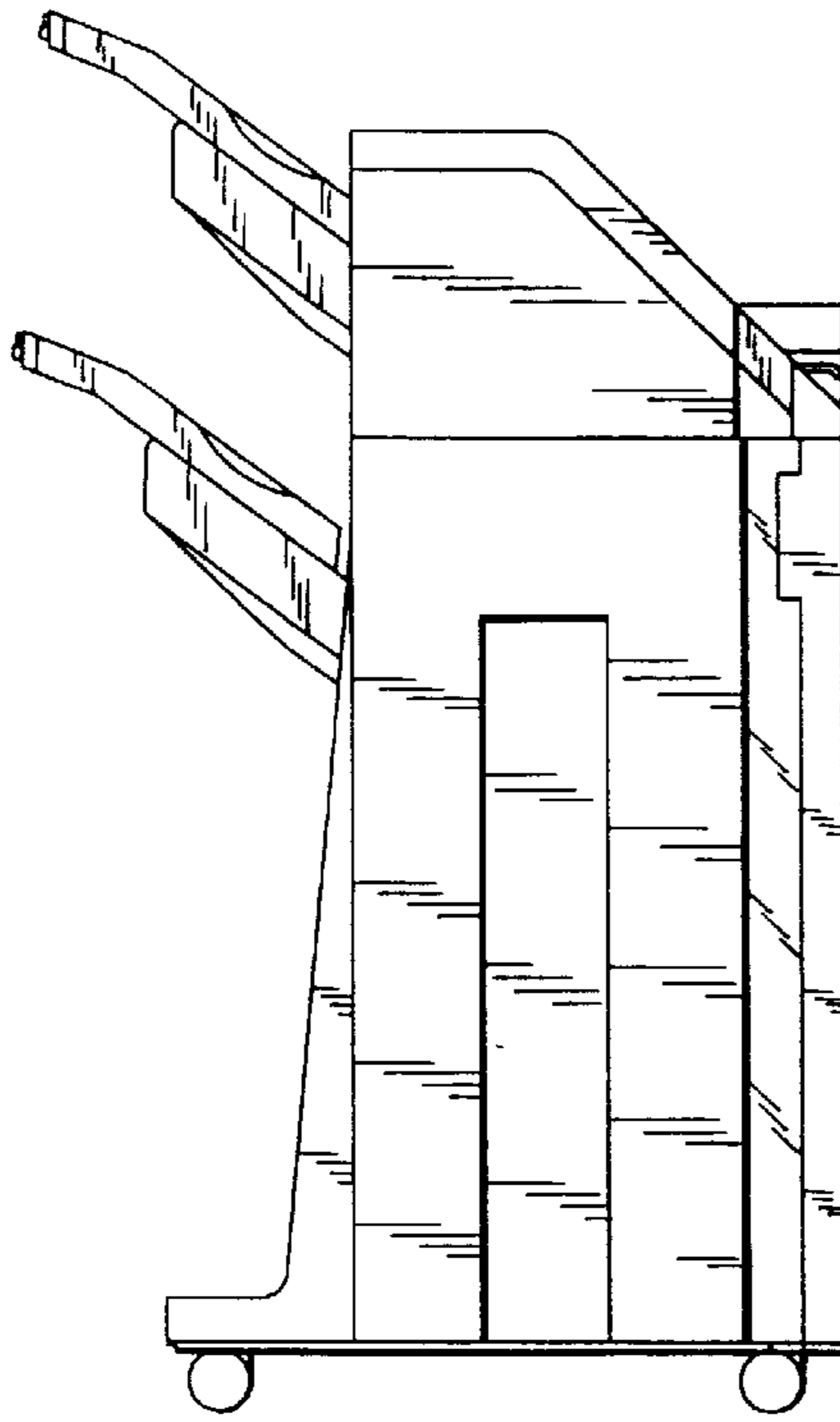

FIG. 2

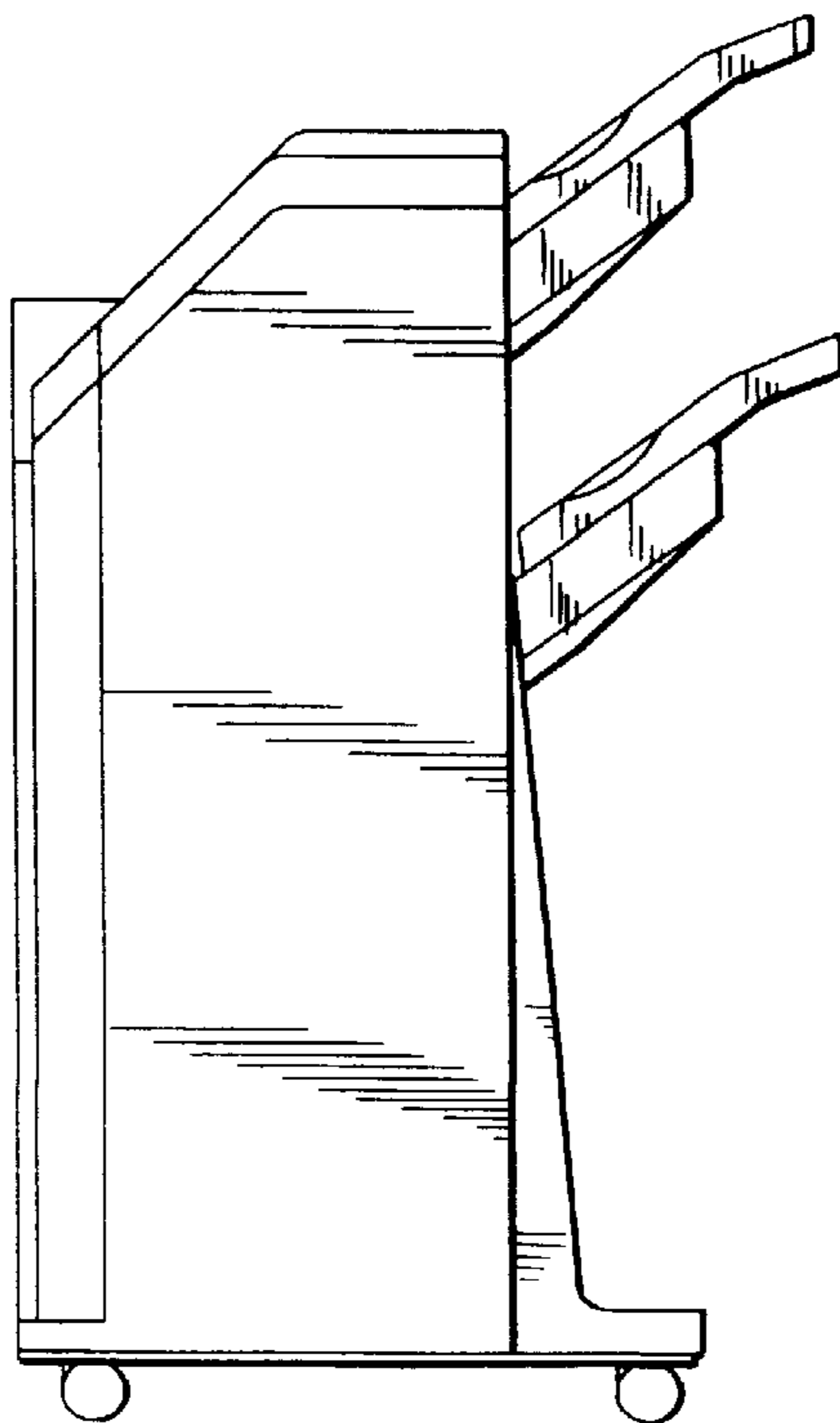

FIG. 3

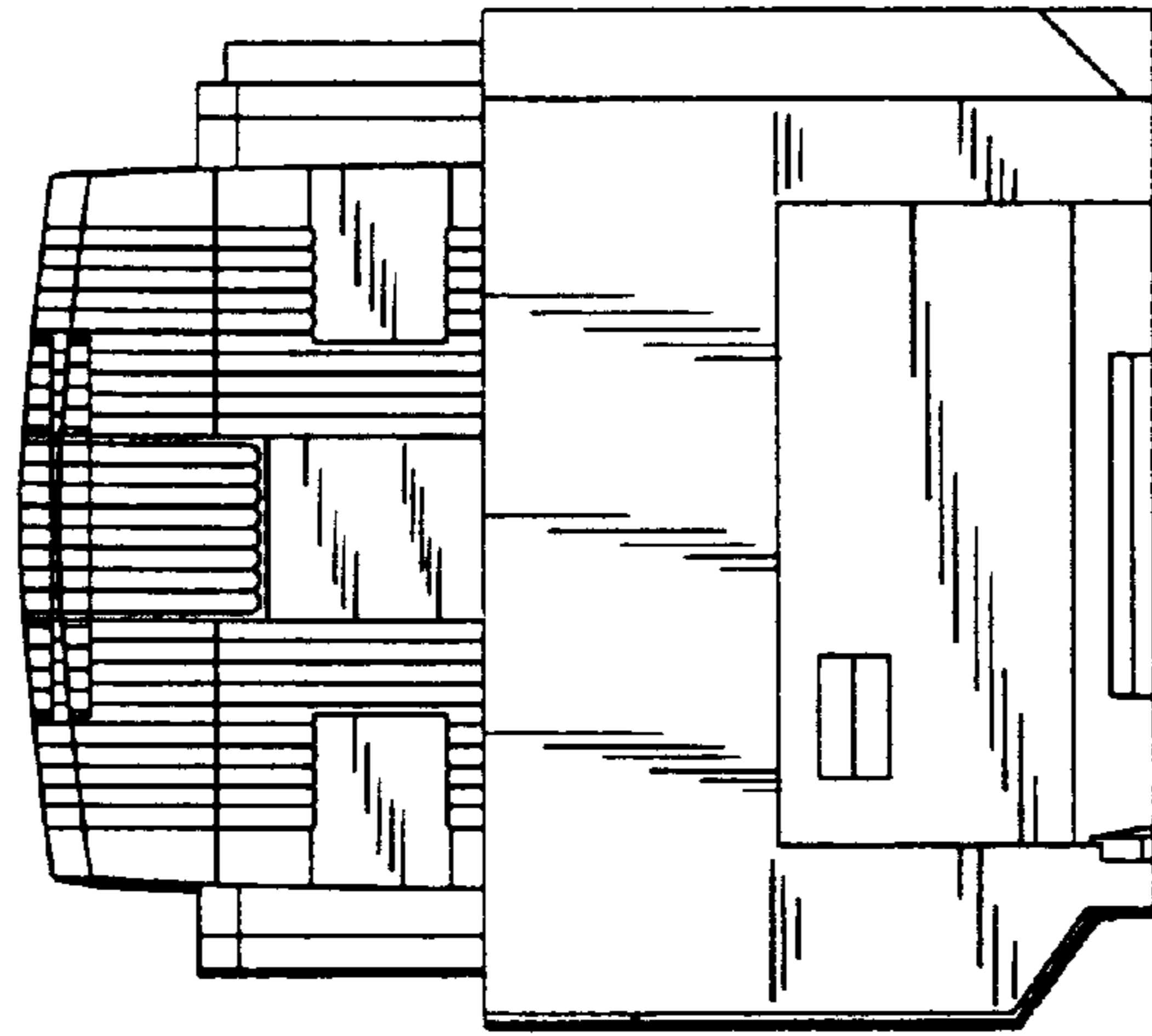

FIG. 4

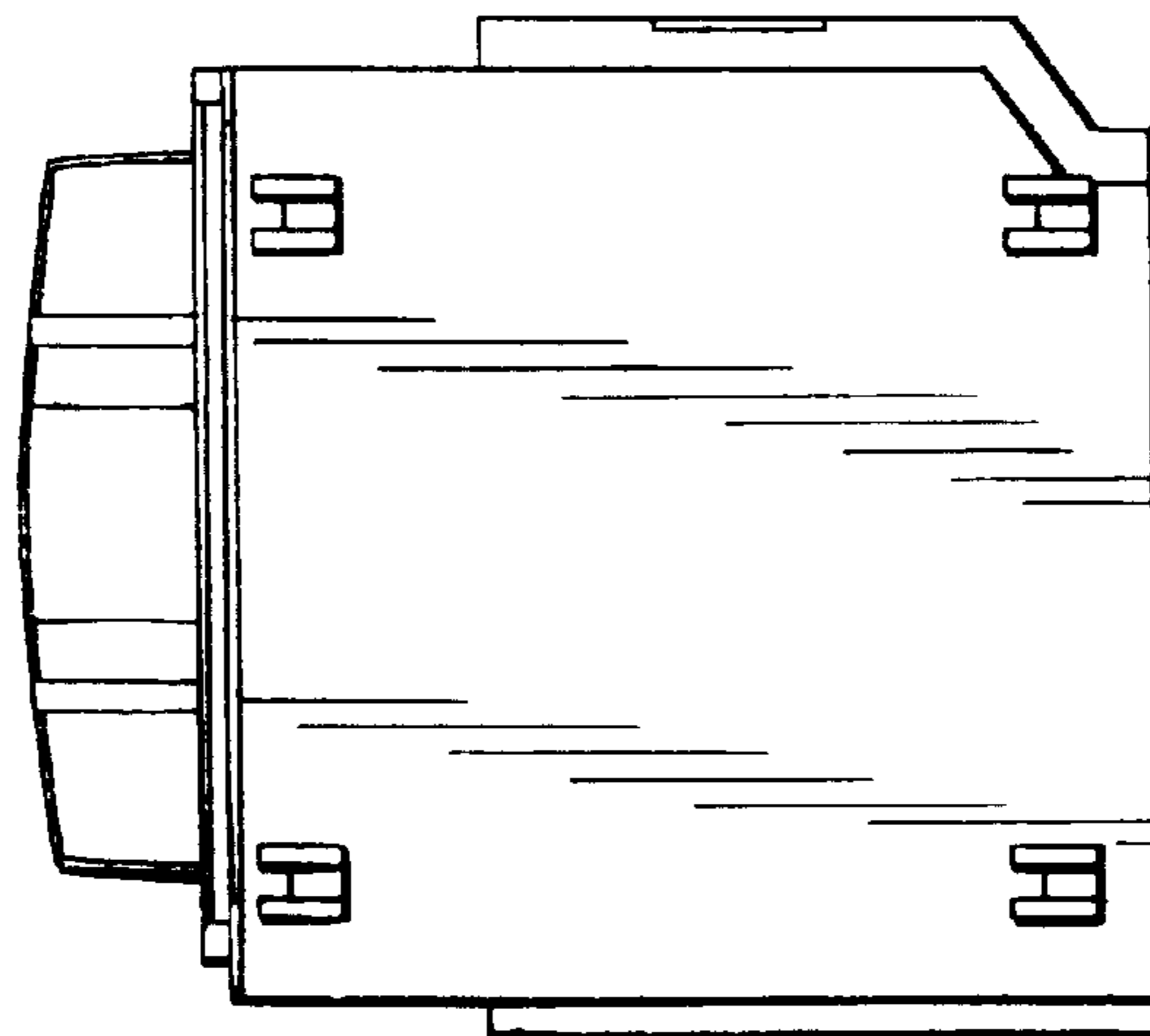

FIG. 5

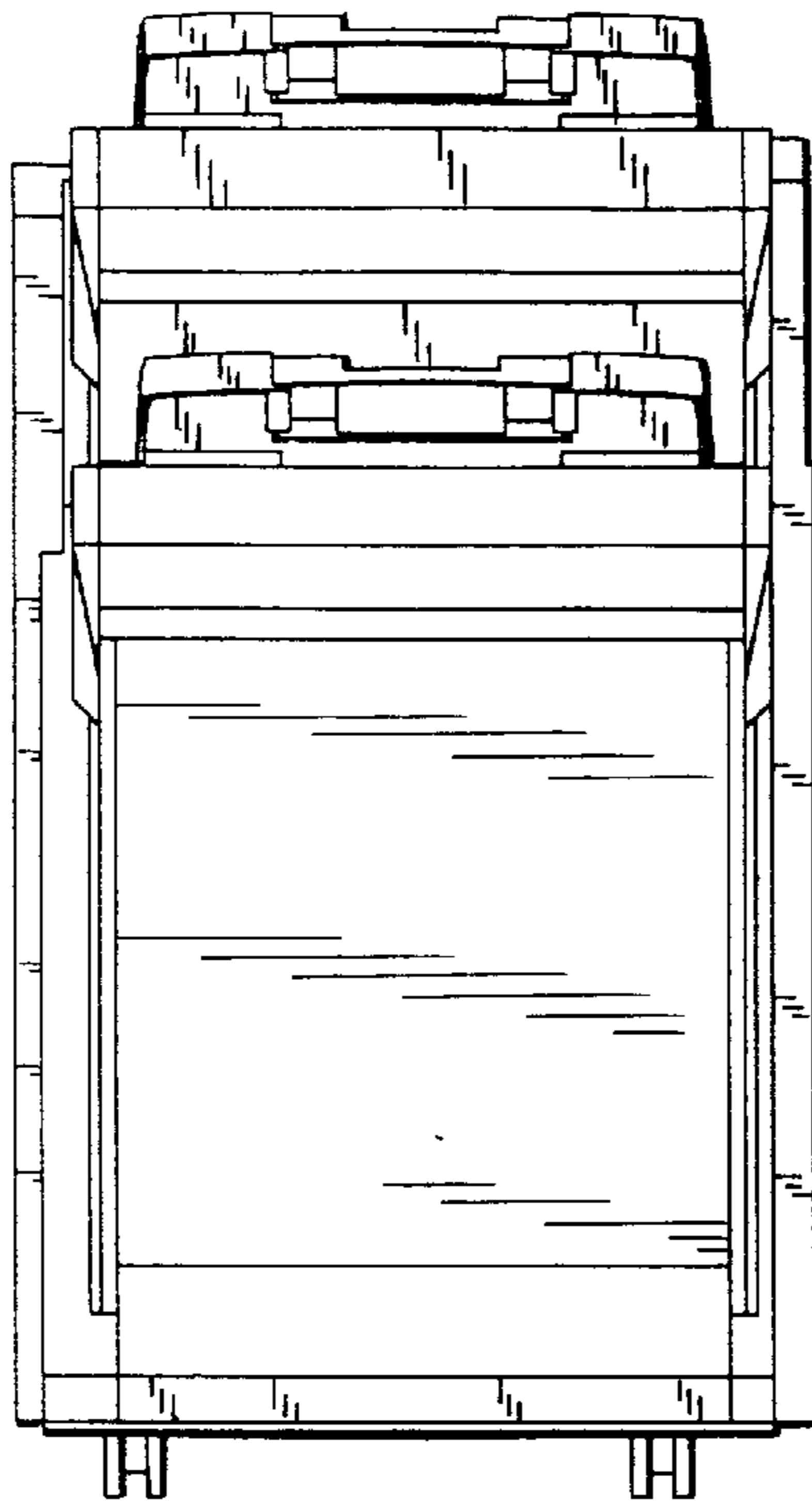

FIG. 6

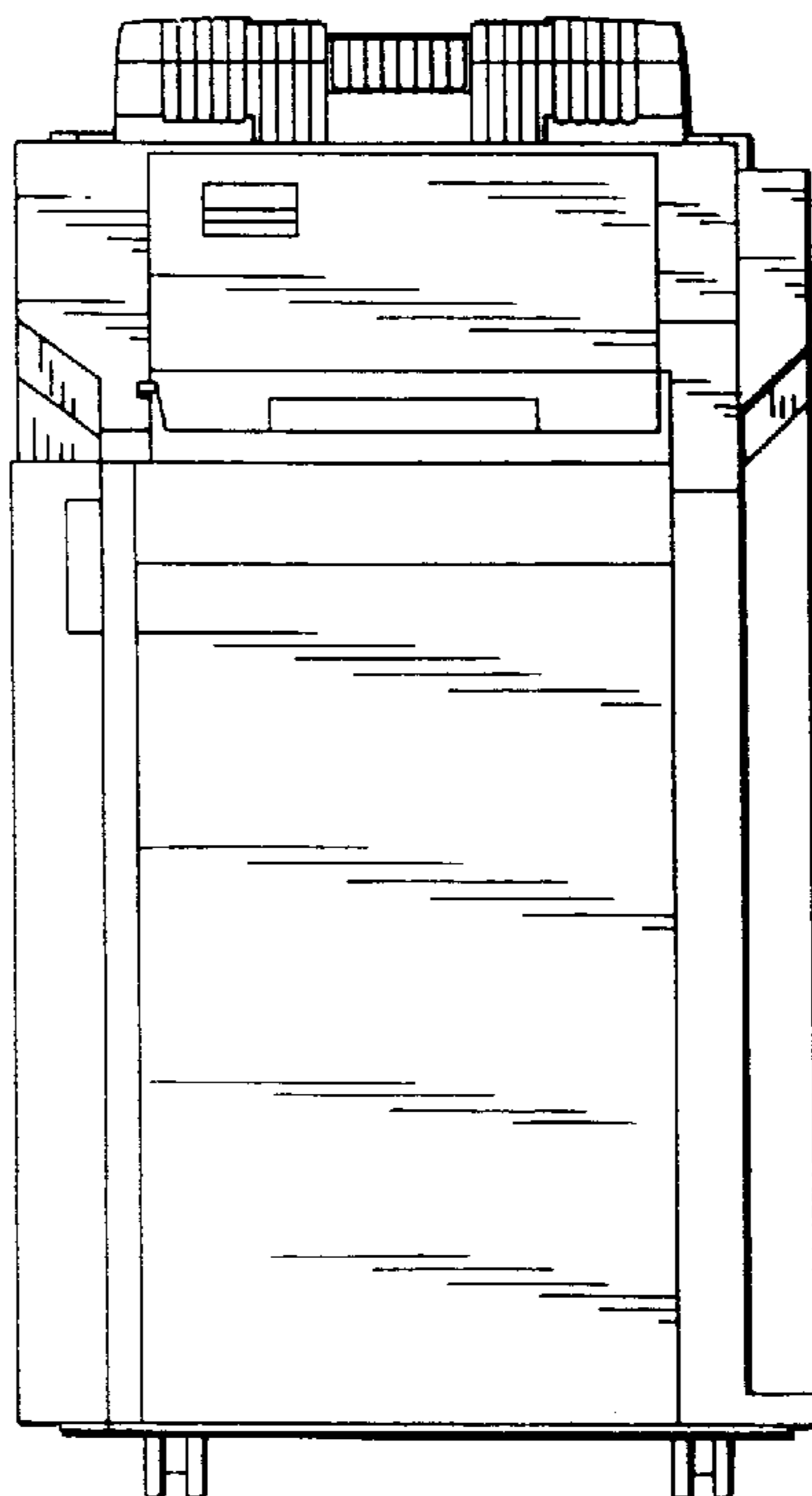

FIG. 7

