



US00D450709B1

(12) **United States Design Patent**
Nakamura

(10) **Patent No.:** **US D450,709 S**

(45) **Date of Patent:** **** Nov. 20, 2001**

(54) **FACSIMILE MACHINE**

(75) **Inventor:** **Masahiro Nakamura, Nara-ken (JP)**

(73) **Assignee:** **Sharp Kabushiki Kaisha, Osaka (JP)**

(**) **Term:** **14 Years**

(21) **Appl. No.:** **29/139,927**

(22) **Filed:** **Apr. 10, 2001**

(30) **Foreign Application Priority Data**

Oct. 16, 2000 (JP) 12-029037

(51) **LOC (7) Cl.** **16-03**

(52) **U.S. Cl.** **D14/463**

(58) **Field of Search** D14/462-471,
D14/496; 358/400, 401, 425; D18/36, 37,
50

(56) **References Cited**

U.S. PATENT DOCUMENTS

- D. 332,094 12/1992 Sawada et al. .
- D. 339,333 9/1993 Sawada et al. .
- D. 355,178 2/1995 Sawada et al. .
- D. 355,179 2/1995 Sawada et al. .
- D. 357,677 4/1995 Sawada et al. .
- D. 361,994 9/1995 Sawada et al. .
- D. 363,713 10/1995 Kanari et al. .
- D. 376,793 12/1996 Satoh et al. .

- D. 383,742 9/1997 Sawada et al. .
- D. 383,744 * 9/1997 Matsushima et al. D14/463
- D. 385,266 10/1997 Matsushima .
- D. 386,490 11/1997 Fujimoto .
- D. 390,551 * 2/1998 Omino D14/462
- D. 407,083 3/1999 Yamamizu .
- D. 431,251 * 9/2000 Fujimoto D14/463
- 5,610,724 * 3/1997 Kaneko et al. 358/400
- 6,144,468 * 11/2000 Watanabe 358/401
- 6,154,286 * 11/2000 Konno et al. 358/401

* cited by examiner

Primary Examiner—Prabhakar Deshmukh

(74) *Attorney, Agent, or Firm*—Nixon & Vanderhye

(57) **CLAIM**

The ornamental design for a “facsimile machine,” as shown and described.

DESCRIPTION

FIG. 1 is a top, front and right side perspective view of a facsimile machine according to my design;
 FIG. 2 is a right side elevational view thereof;
 FIG. 3 is a left side elevational view thereof;
 FIG. 4 is a front elevational view thereof;
 FIG. 5 is a rear elevational view thereof;
 FIG. 6 is a bottom plan view thereof; and,
 FIG. 7 is a top plan view thereof.

1 Claim, 7 Drawing Sheets

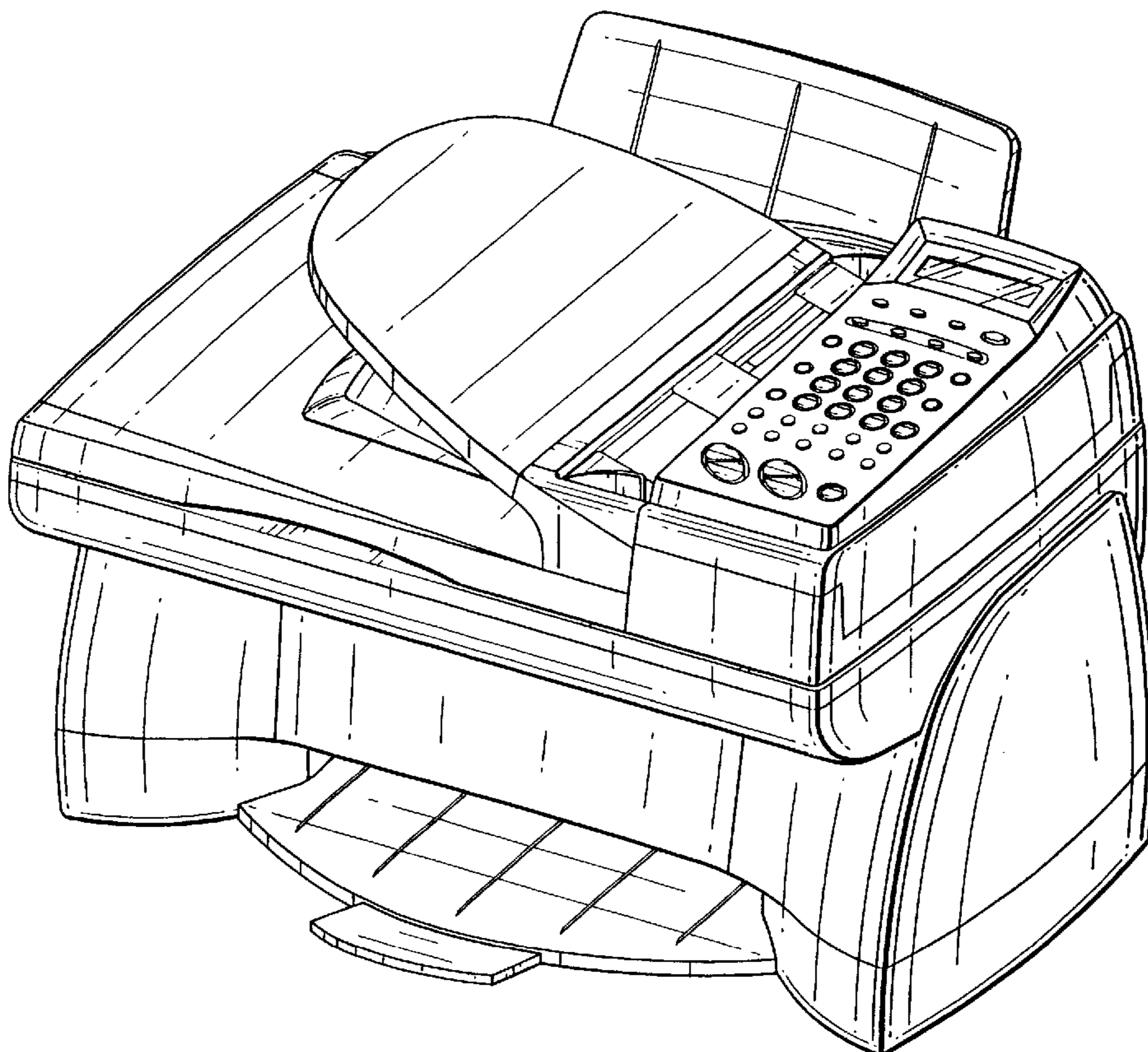

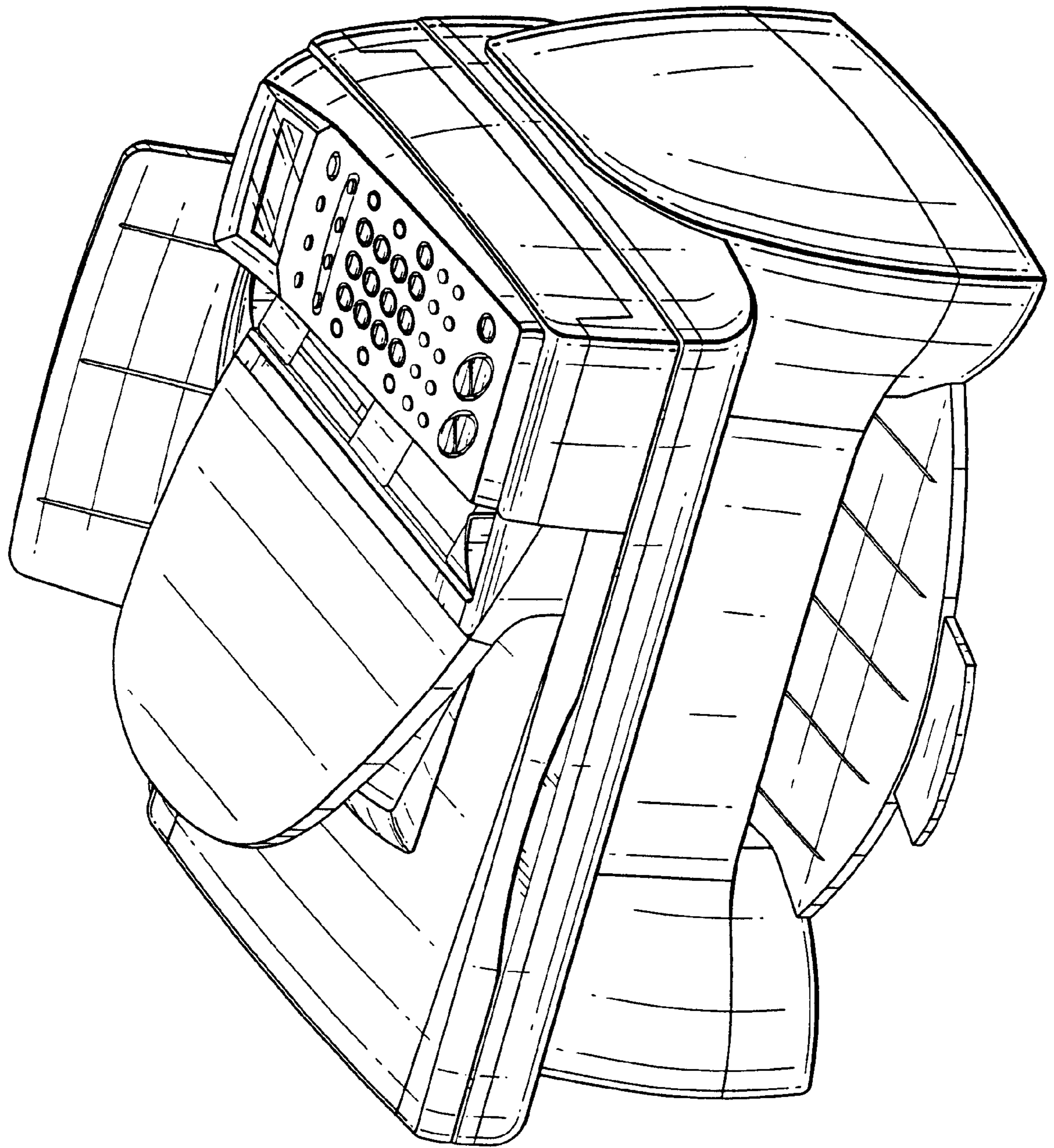

Fig. 1

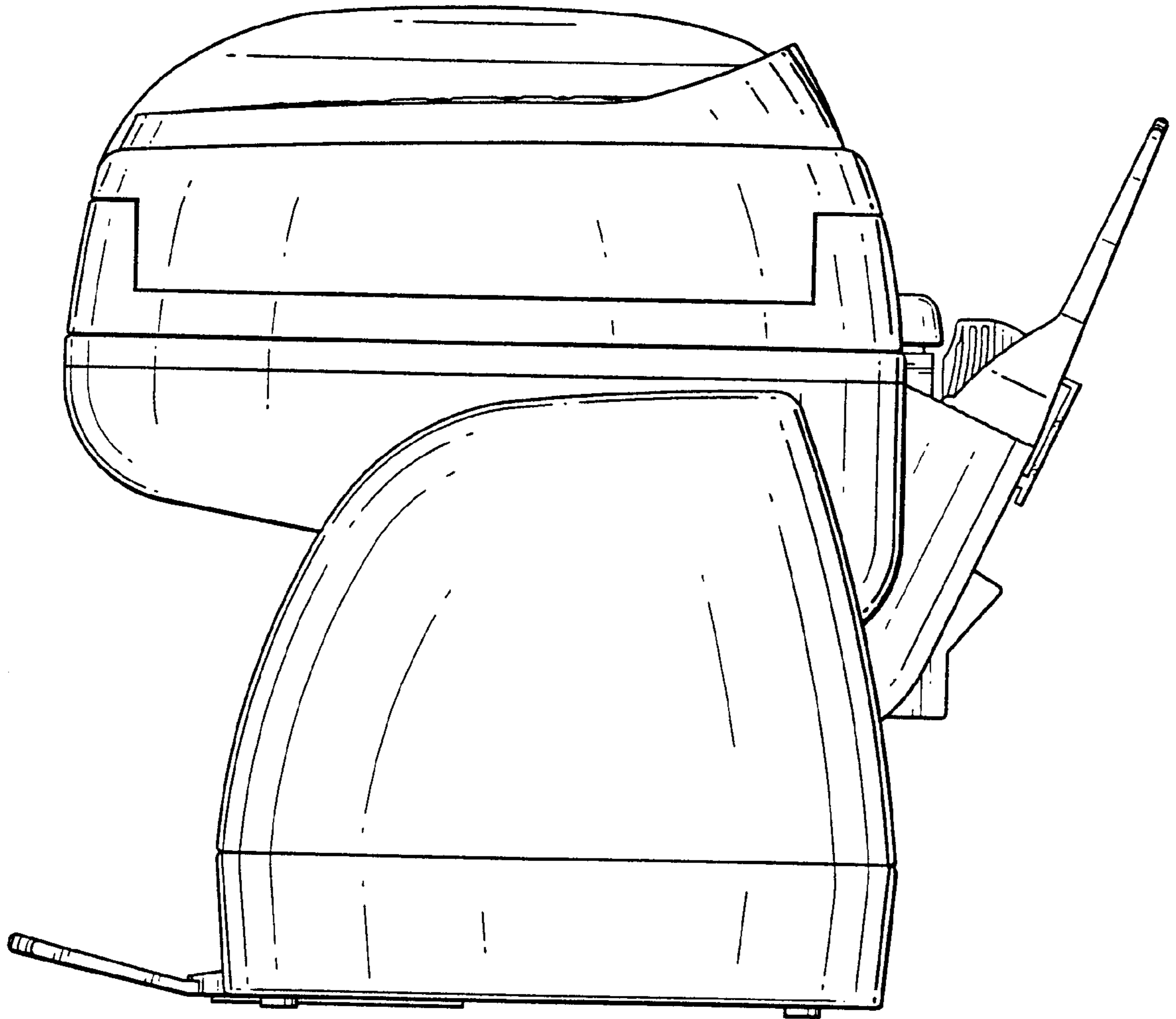

Fig. 2

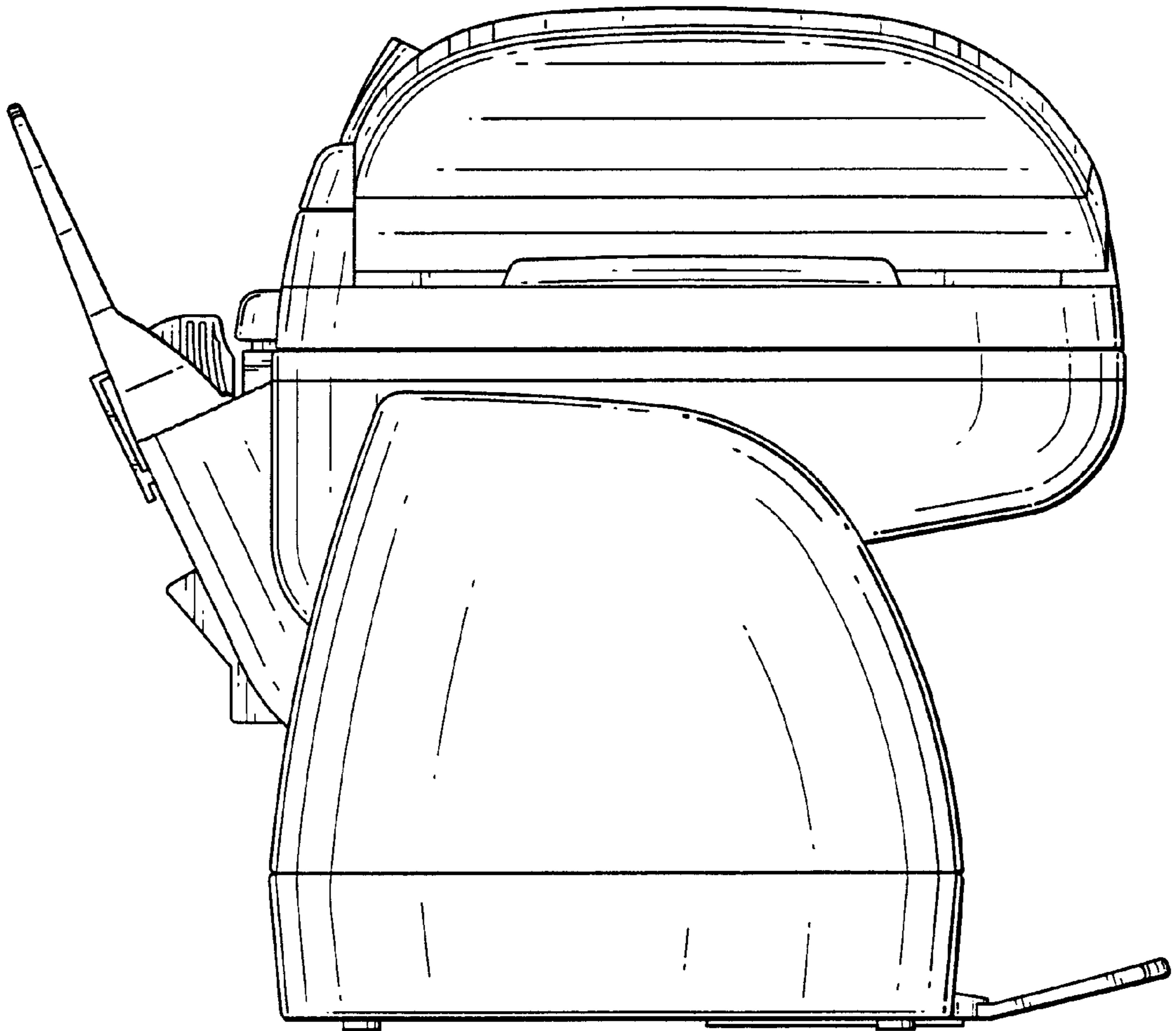

Fig. 3

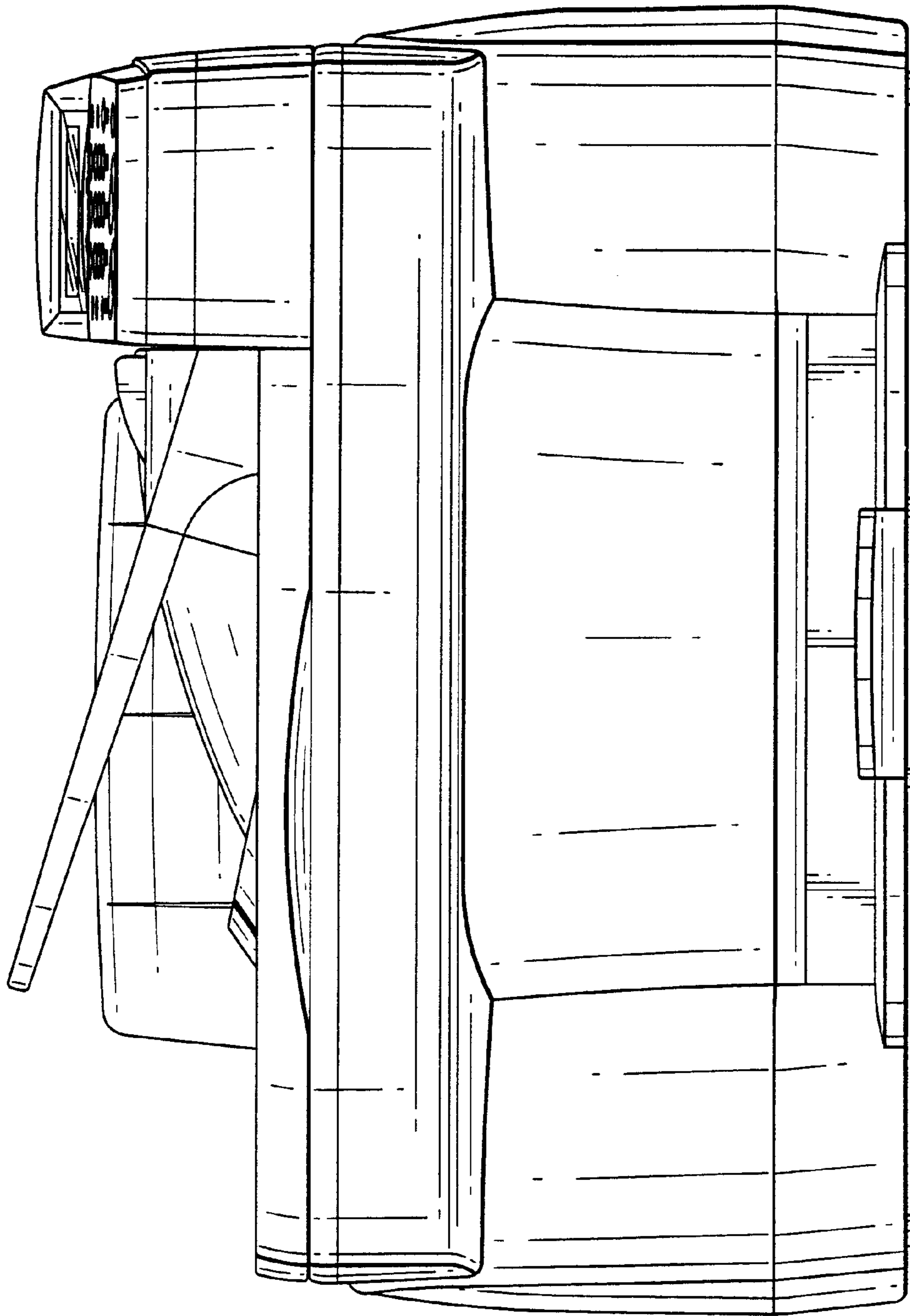

Fig. 4

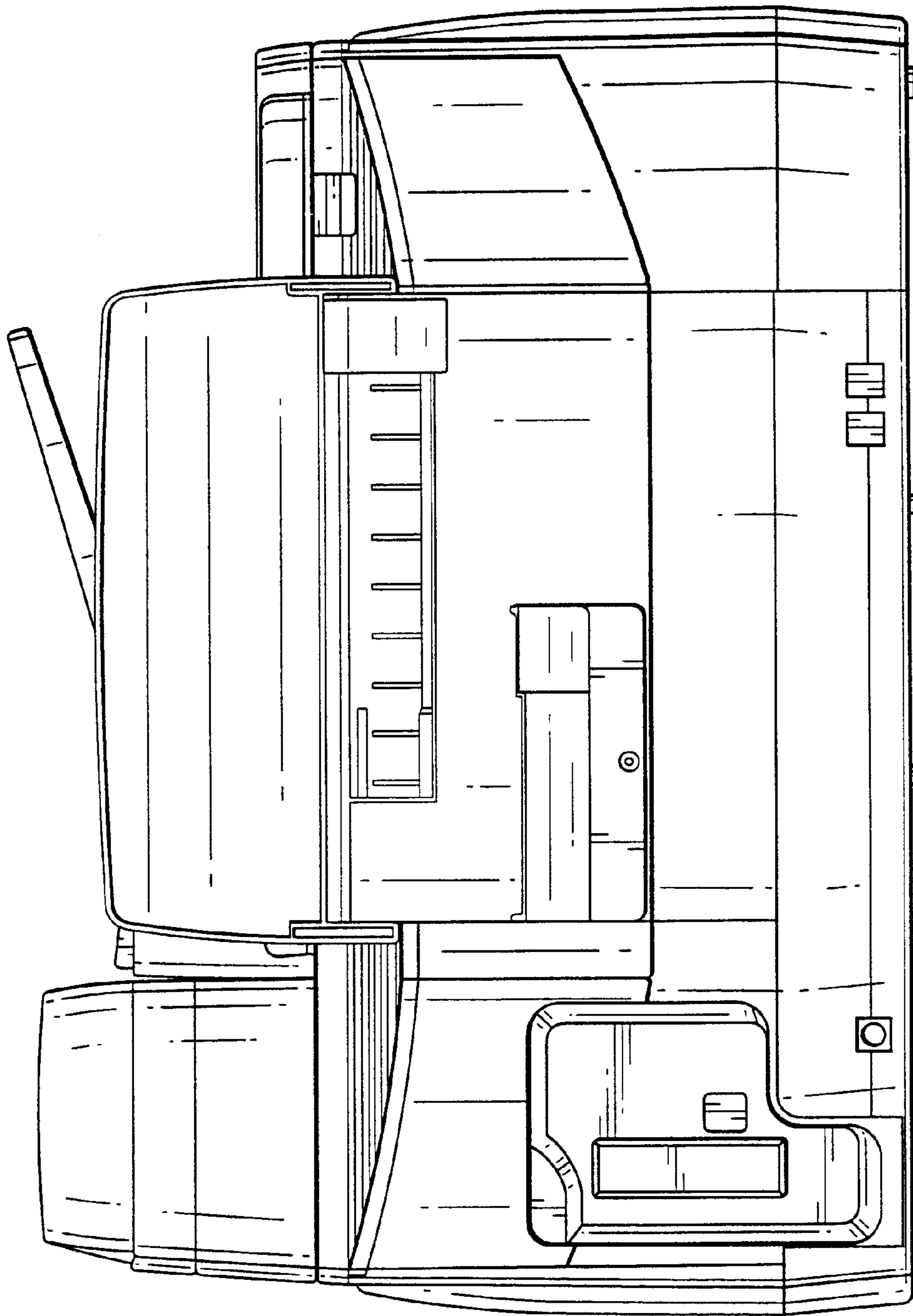

Fig. 5

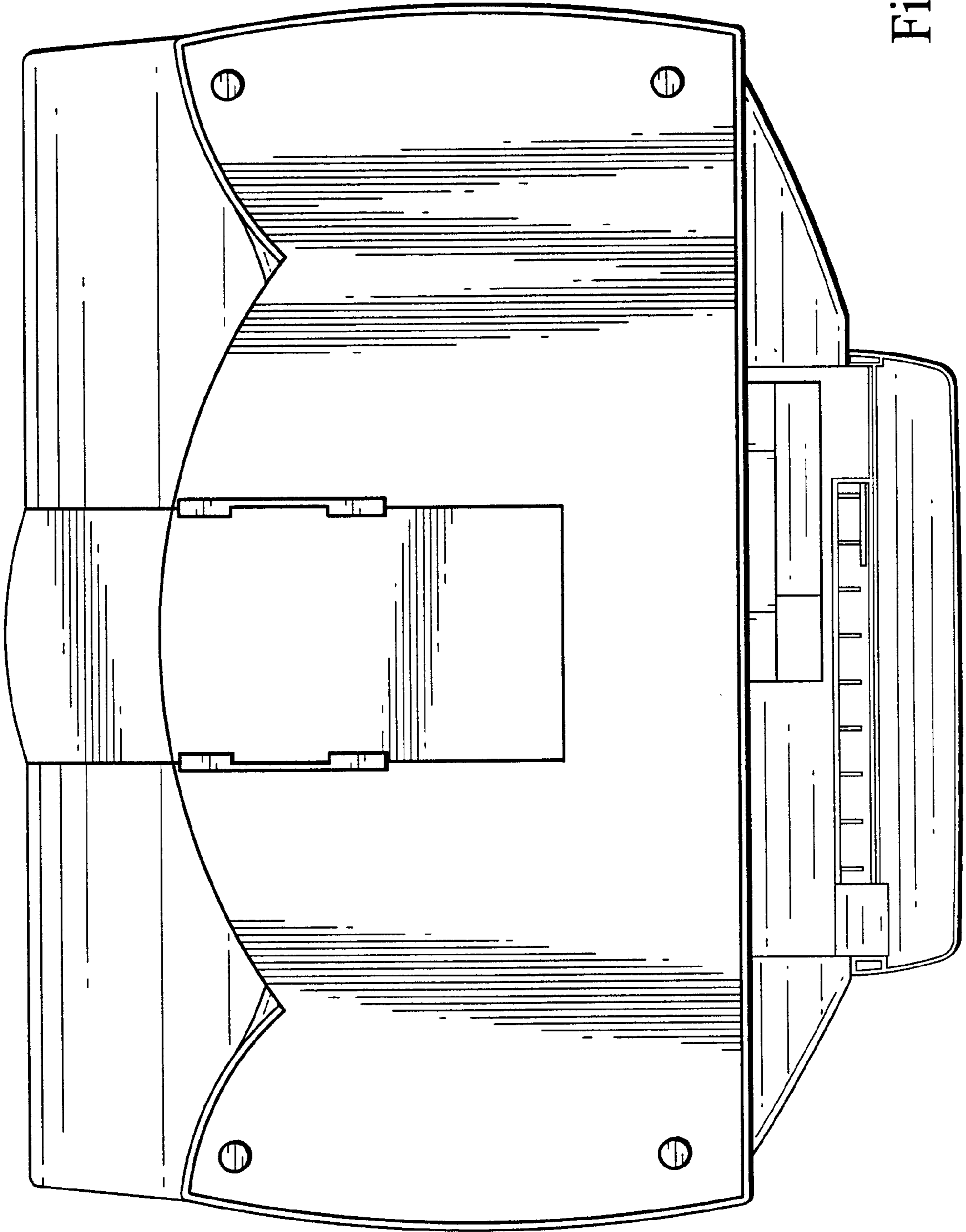

Fig. 6

Fig. 7

