



US00D450552B1

(12) **United States Design Patent**
Mason

(10) **Patent No.:** **US D450,552 S**

(45) **Date of Patent:** **** Nov. 20, 2001**

(54) **SAW BLADE WITH DECORATIVE SHANK**

(75) Inventor: **Neil Mason**, Newton Aycliffe (GB)

(73) Assignee: **Black & Decker Inc.**, Newark, DE (US)

(**) Term: **14 Years**

(21) Appl. No.: **29/113,841**

(22) Filed: **Nov. 12, 1999**

(30) **Foreign Application Priority Data**

May 12, 1999	(GB)	2083309
May 12, 1999	(GB)	2083310
May 12, 1999	(GB)	2083311

(51) **LOC (7) Cl.** **08-03**

(52) **U.S. Cl.** **D8/20**

(58) **Field of Search** D8/20, 64, 70;
D24/146; 30/166.3, 340, 342, 349, 353,
394, 502, 517; 83/835-855, 697, 699.21,
746; 606/176, 177, 178

(56) **References Cited**

U.S. PATENT DOCUMENTS

D. 406,501	*	3/1999	Schultz et al.	D8/20
D. 415,401	*	10/1999	Imboden et al.	83/835
1,380,629	*	6/1921	Barnett	30/349
2,017,895	*	10/1935	Davey	30/517
2,695,641	*	11/1954	Behr	83/697
3,028,889	*	4/1962	McCarty	83/852
4,953,301	*	9/1990	Dobbs, Jr.	83/835

* cited by examiner

Primary Examiner—Doris V. Coles
Assistant Examiner—Elizabeth A. Albert
(74) *Attorney, Agent, or Firm*—Charles E. Yocum

(57) **CLAIM**

The ornamental design for saw blade with decorative shank, as shown and described.

DESCRIPTION

FIG. 1 is a side elevation view of a saw blade with decorative shank;
 FIG. 2 is an opposite side elevation view thereof;
 FIG. 3 is a top plan view thereof;
 FIG. 4 is a bottom plan view thereof;
 FIG. 5 is a rear elevation view thereof;
 FIG. 6 is a front elevation view thereof;
 FIG. 7 is a side elevation view of a saw blade with a decorative shank showing a second embodiment of the design;
 FIG. 8 is an opposite side elevation view of FIG. 7;
 FIG. 9 is a front elevation view of FIG. 7;
 FIG. 10 is a rear elevation view of FIG. 7;
 FIG. 11 is a top plan view of FIG. 7;
 FIG. 12 is a bottom plan view of FIG. 7;
 FIG. 13 is a side elevation view of a saw blade with a decorative shank showing a third embodiment of the design;
 FIG. 14 is an opposite side elevation view of FIG. 13;
 FIG. 15 is a front elevation view of FIG. 13;
 FIG. 16 is a rear elevation view of FIG. 13;
 FIG. 17 is a top plan view of FIG. 13; and,
 FIG. 18 is a bottom plan view of FIG. 13.
 The broken lines are for illustrative purposes only, and form no part of the claimed design.

1 Claim, 6 Drawing Sheets

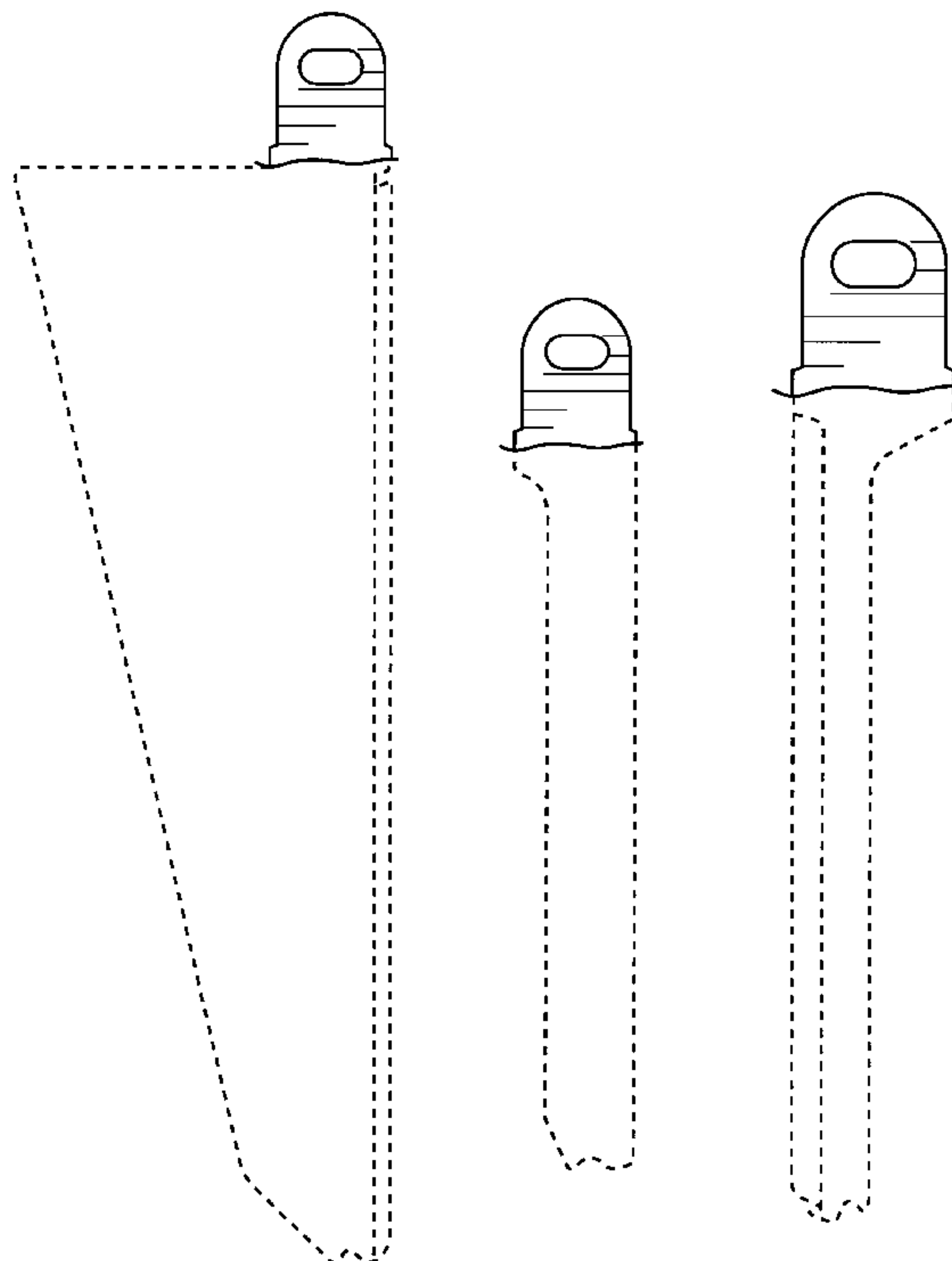

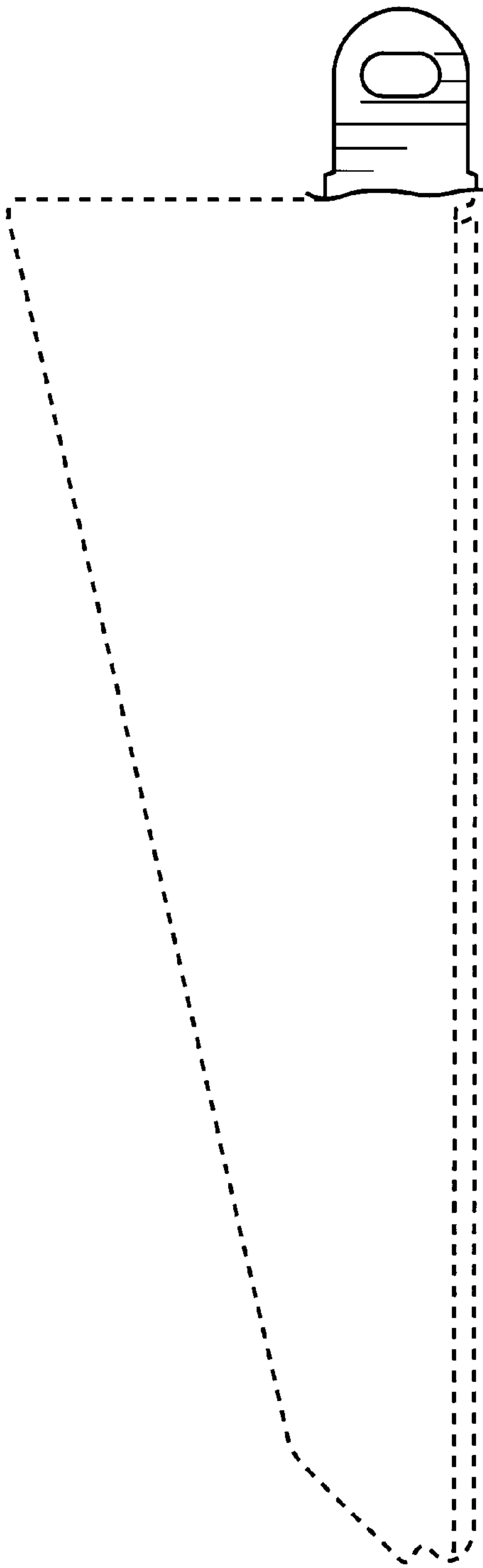

FIG. 1

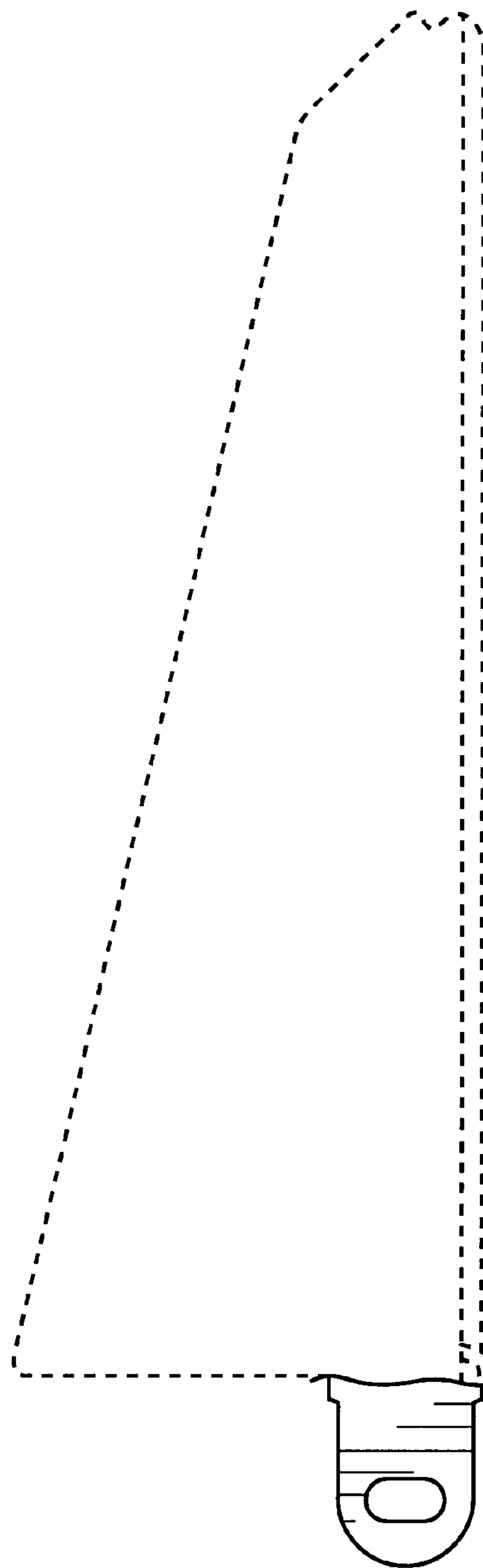

FIG. 2



FIG. 3

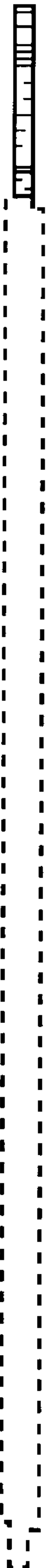

FIG. 4

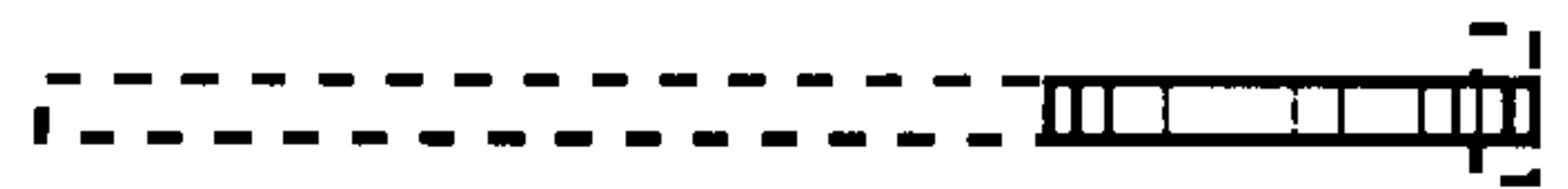

FIG. 5

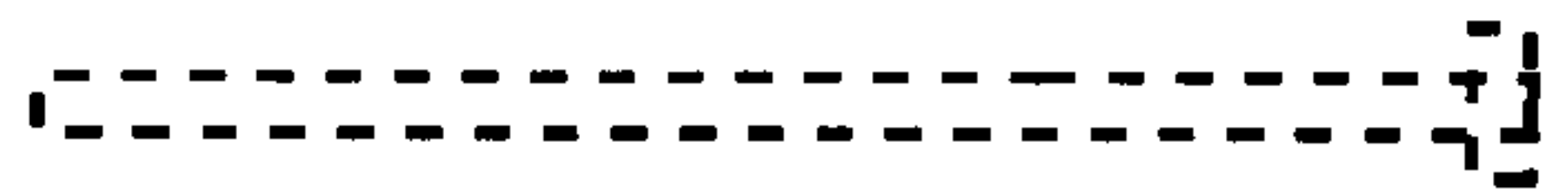

FIG. 6

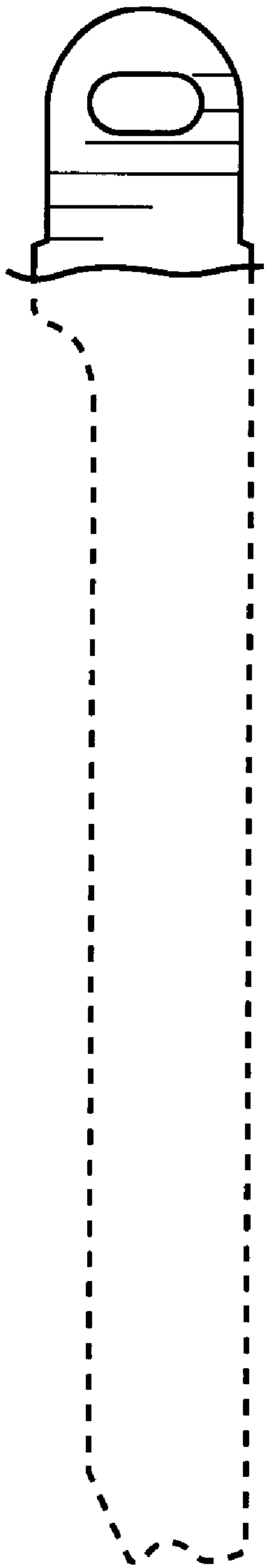

FIG. 7

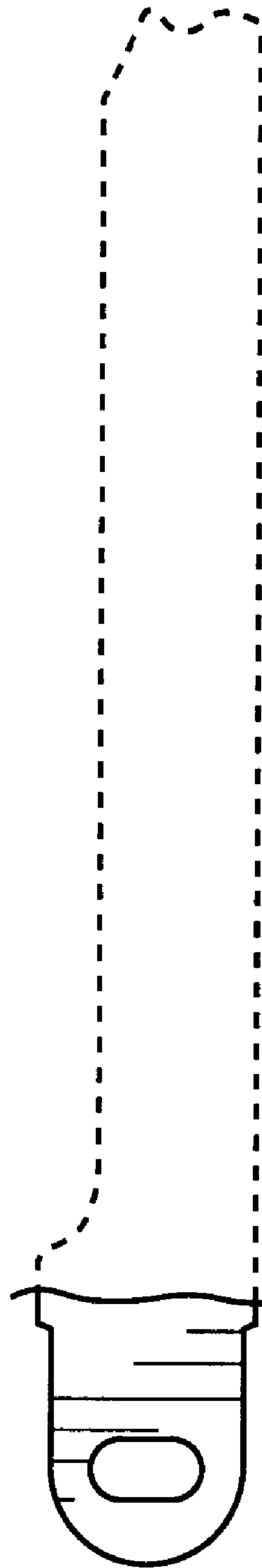

FIG. 8

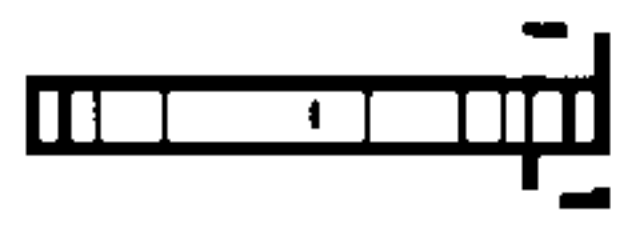

FIG. 9

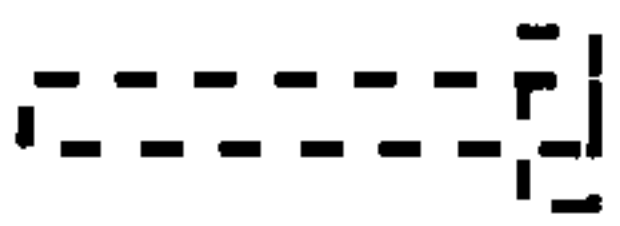

FIG. 10



FIG. 11



FIG. 12

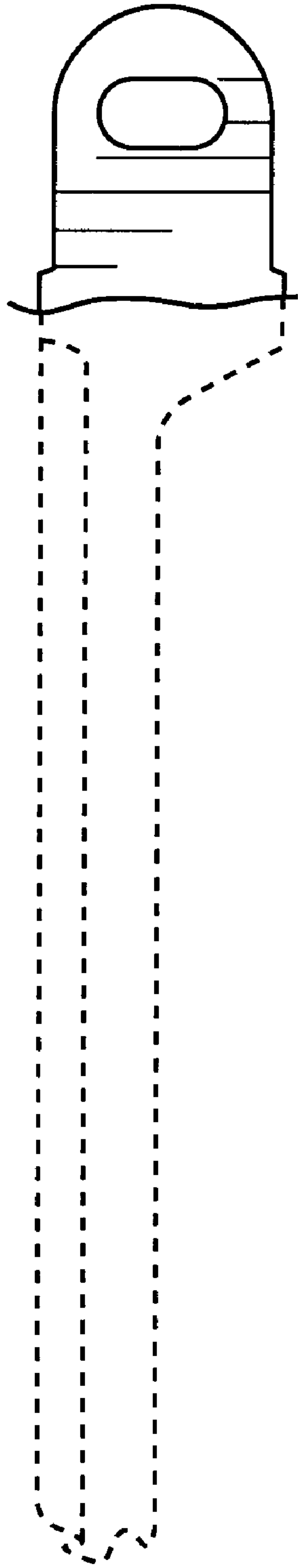

FIG. 13

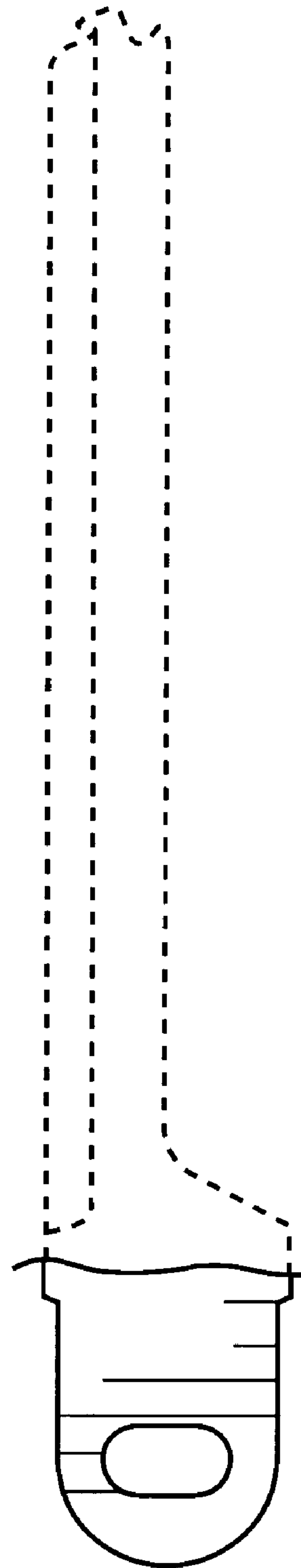

FIG. 14

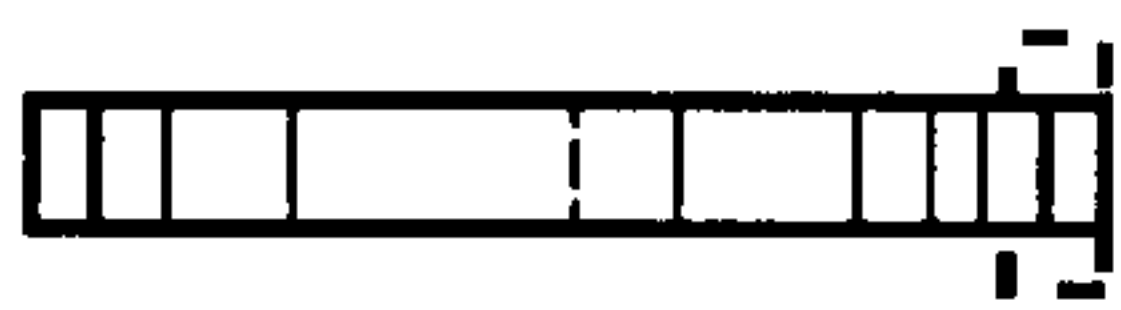

FIG. 15

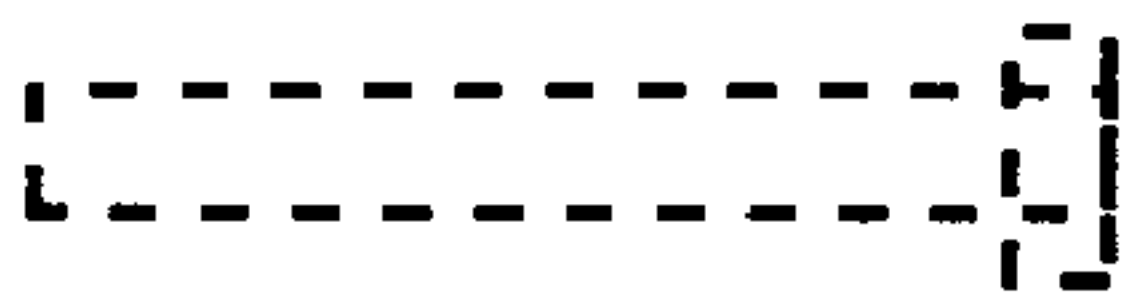

FIG. 16



FIG. 17



FIG. 18