



US00D450529B1

(12) **United States Design Patent**  
**Smith**

(10) **Patent No.:** **US D450,529 S**

(45) **Date of Patent:** **\*\* Nov. 20, 2001**

(54) **BLENDER**

(75) Inventor: **Michael Smith**, Glen Allen, VA (US)

(73) Assignee: **Hamilton Beach/Proctor-Silex, Inc.**,  
Glen Allen, VA (US)

(\*\*) Term: **14 Years**

(21) Appl. No.: **29/136,609**

(22) Filed: **Feb. 2, 2001**

(51) **LOC (7) Cl.** ..... **31-00**

(52) **U.S. Cl.** ..... **D7/378**

(58) **Field of Search** ..... D7/372, 376-386,  
D7/412, 413; 241/33, 101.01, 282.2, 285.1,  
285.2, 301; 366/65, 197, 199, 241, 349

(56) **References Cited**

**U.S. PATENT DOCUMENTS**

- D. 184,306 \* 1/1959 De Angelis et al. .... D7/378
- D. 233,929 \* 12/1974 Yuen ..... D7/376
- D. 301,297 5/1989 Barrault .
- D. 309,548 7/1990 McCloskey .
- D. 319,950 9/1991 Maass .
- D. 339,715 9/1993 Barrault .
- D. 346,526 5/1994 Bannigan .
- D. 347,966 6/1994 Doggett .
- D. 349,423 8/1994 Burgel .
- D. 367,800 3/1996 Littmann .
- D. 370,151 5/1996 McLinden et al. .
- D. 373,504 9/1996 Leverrier .
- D. 383,644 9/1997 Feil .
- D. 386,355 11/1997 Davidson et al. .
- D. 386,941 12/1997 Barker .
- D. 387,948 12/1997 Leverrier .

- D. 394,984 6/1998 Andrieu .
- D. 394,986 6/1998 Lallemand .
- D. 396,990 8/1998 Leverrier .
- D. 400,757 11/1998 Hippen et al. .
- D. 403,202 12/1998 Cousins .
- D. 404,247 1/1999 Spagnolo .
- D. 404,606 1/1999 Huang .
- D. 404,607 1/1999 Huang .
- D. 412,809 8/1999 Toro et al. .
- D. 417,581 12/1999 Barthelemy et al. .
- D. 422,448 4/2000 Kindig et al. .
- 3,537,691 \* 11/1970 Tsuruta et al. .... 241/282.2

\* cited by examiner

*Primary Examiner*—Caron D. Veynar

(74) *Attorney, Agent, or Firm*—Akin, Gump, Strauss,  
Hauer & Feld, L.L.P.

(57) **CLAIM**

The ornamental design for a blender, as shown and described.

**DESCRIPTION**

FIG. 1 is a front perspective view of a blender in accordance with my new design;  
 FIG. 2 is a front elevational view thereof;  
 FIG. 3 is a right side elevational view thereof;  
 FIG. 4 is a rear elevational view thereof;  
 FIG. 5 is a left side elevational view thereof;  
 FIG. 6 is a top plan view thereof; and,  
 FIG. 7 is a bottom plan view thereof.  
 The broken lines shown in the drawings are for illustrative purposes only and form no part of the claimed design.

**1 Claim, 4 Drawing Sheets**

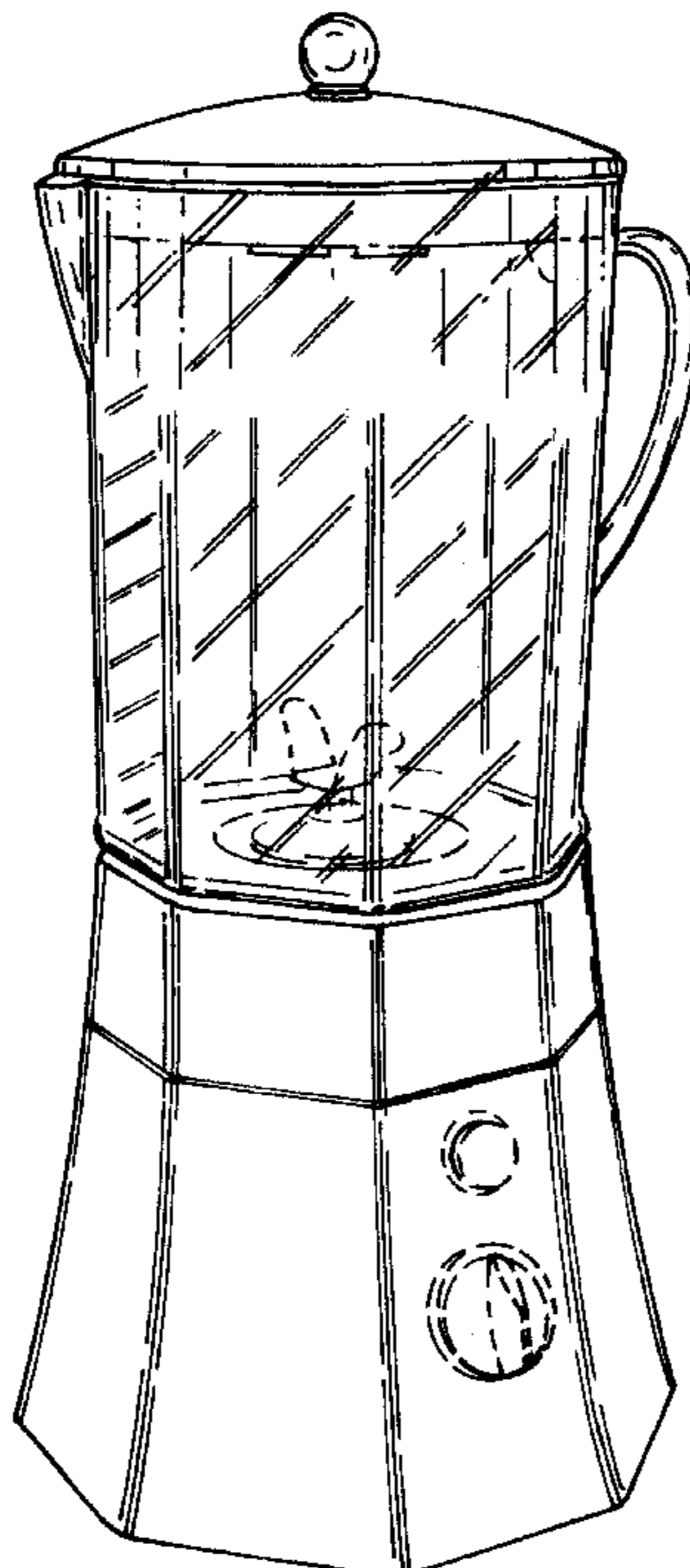

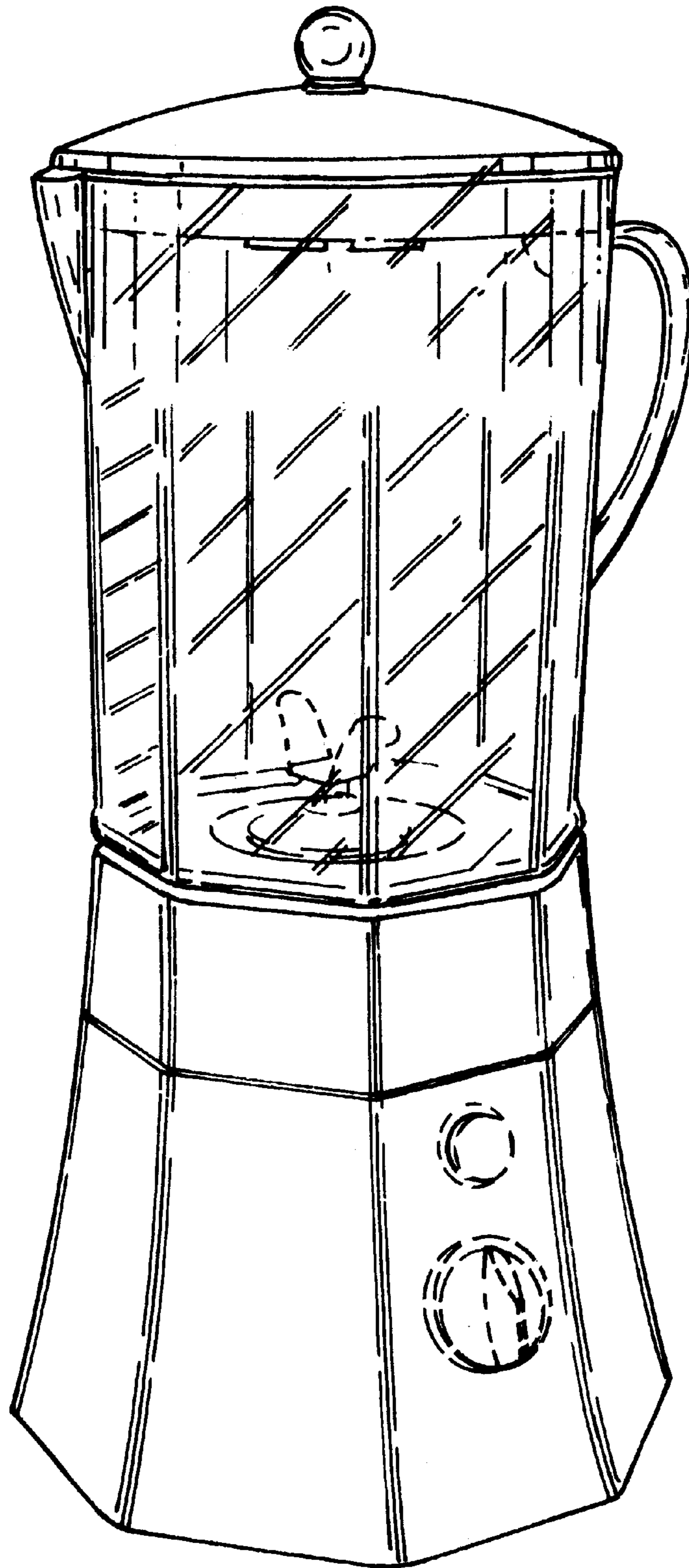

**Fig. 1**

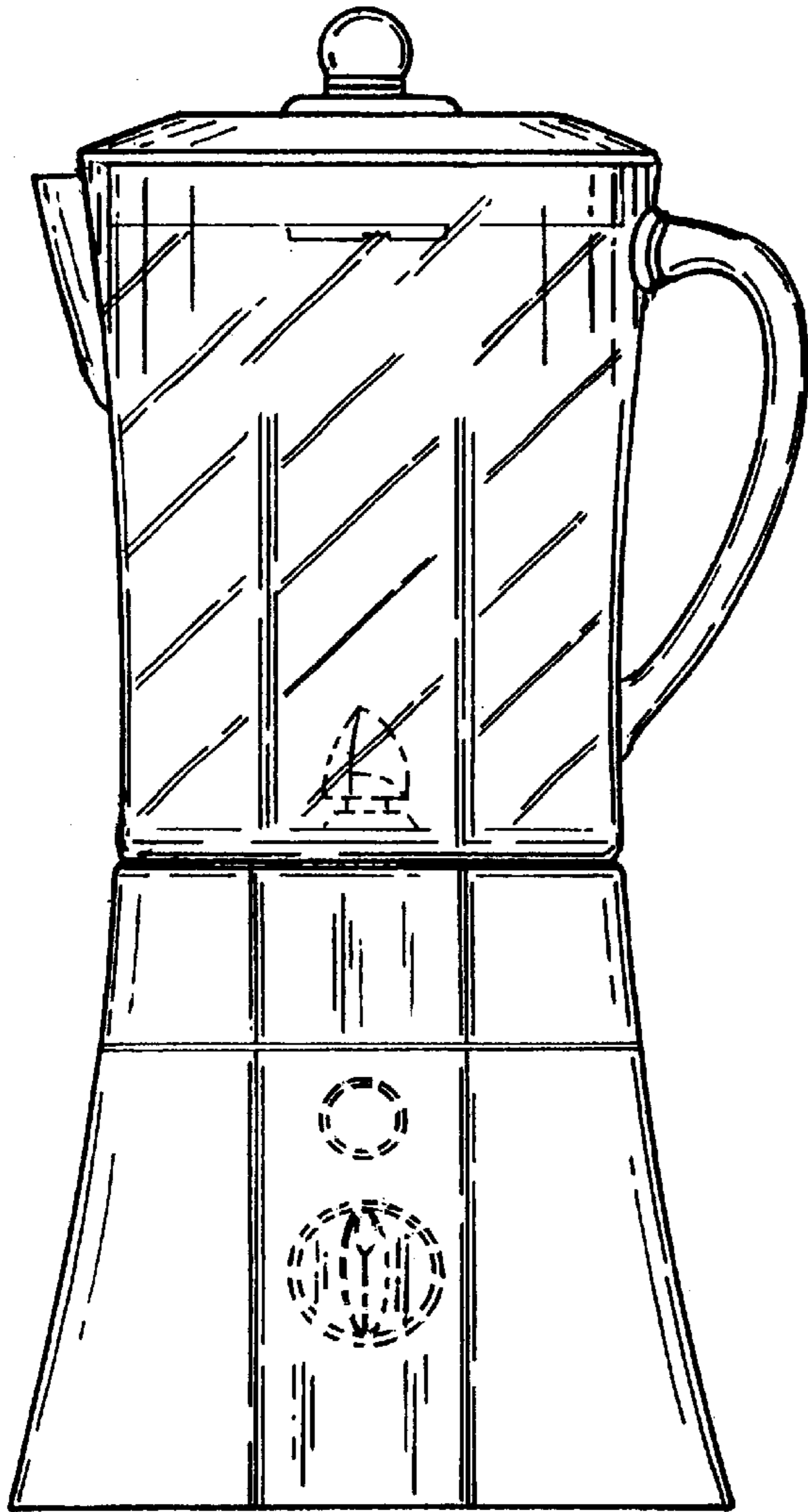

Fig. 2

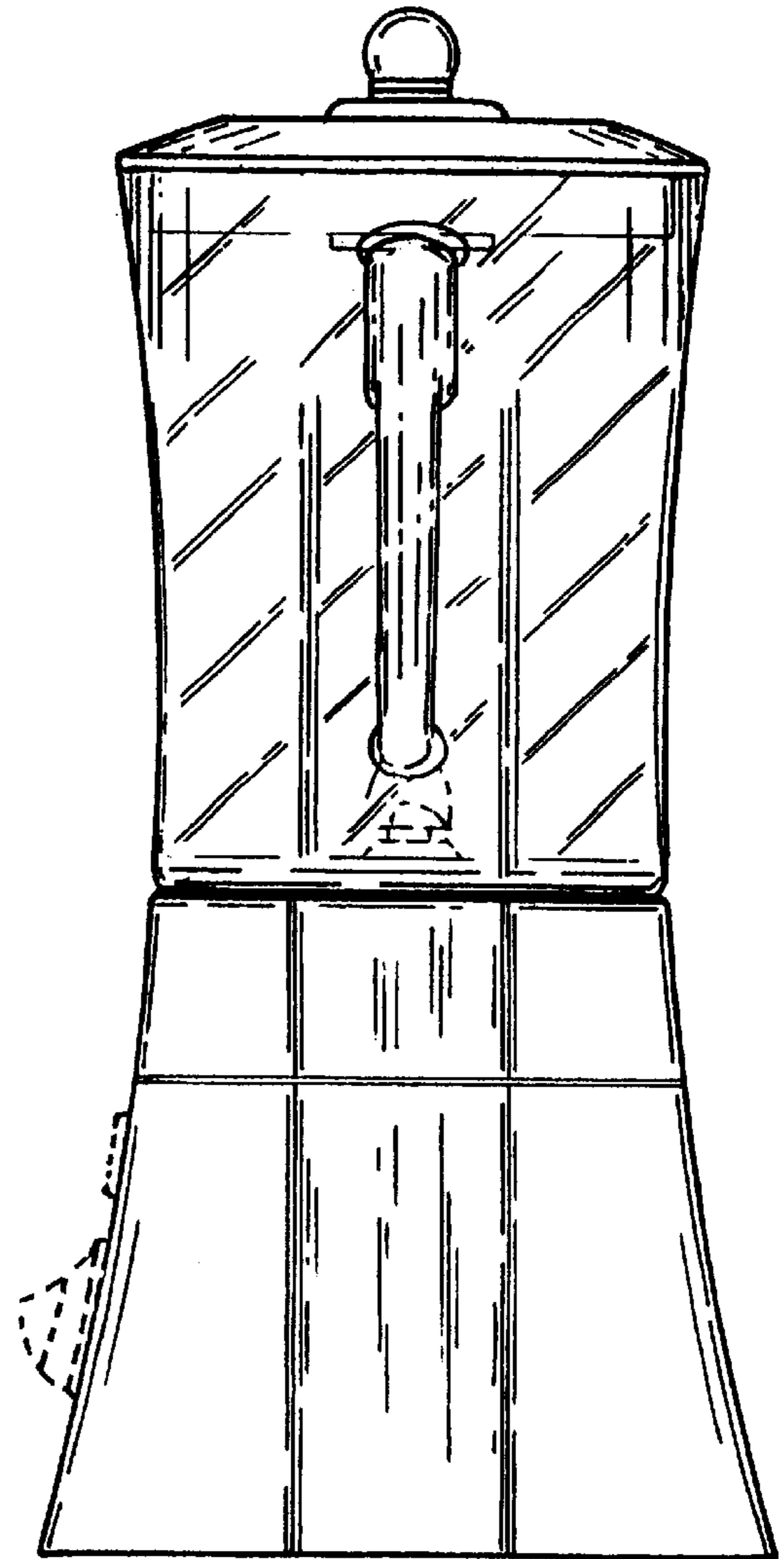
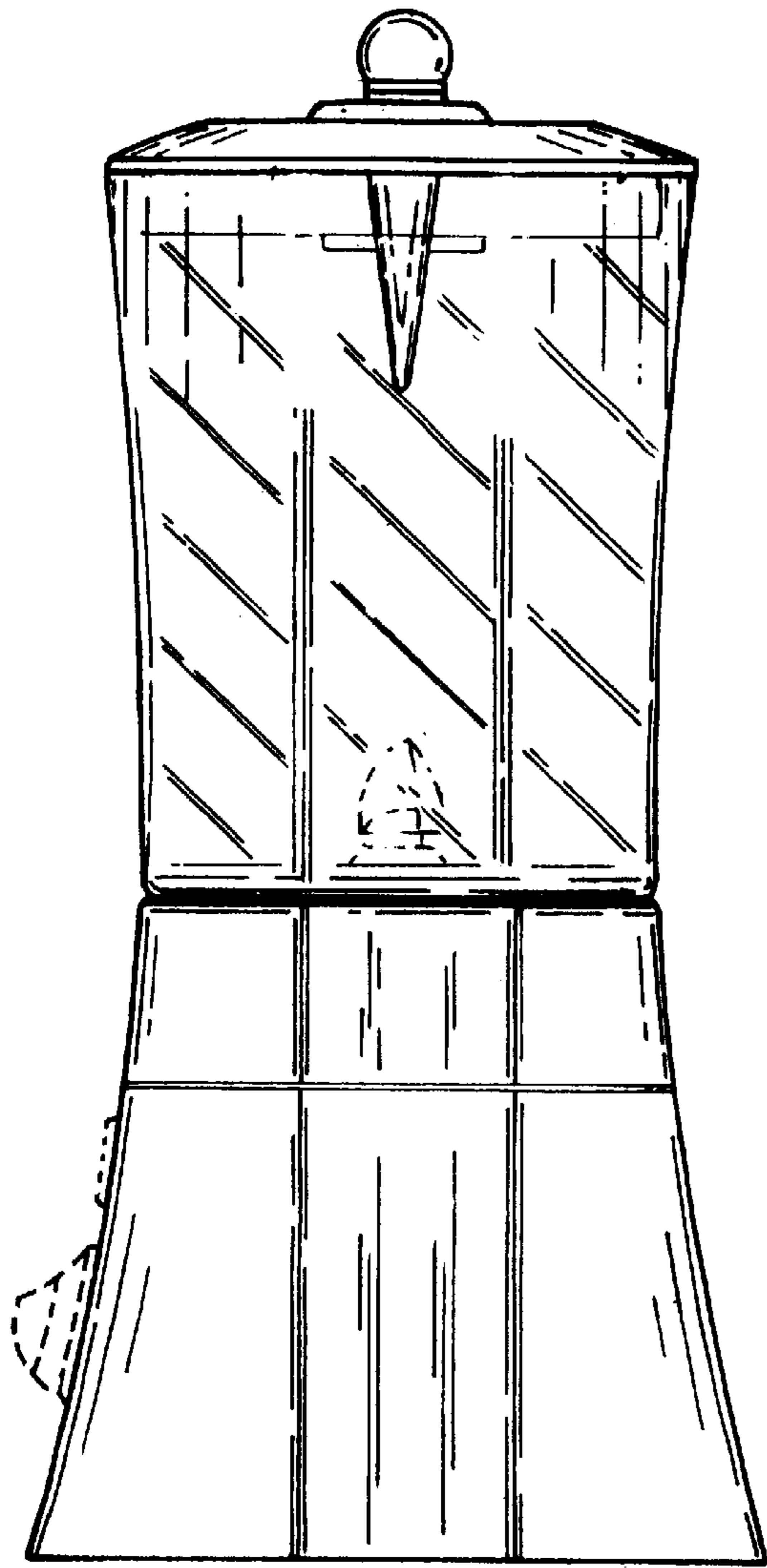
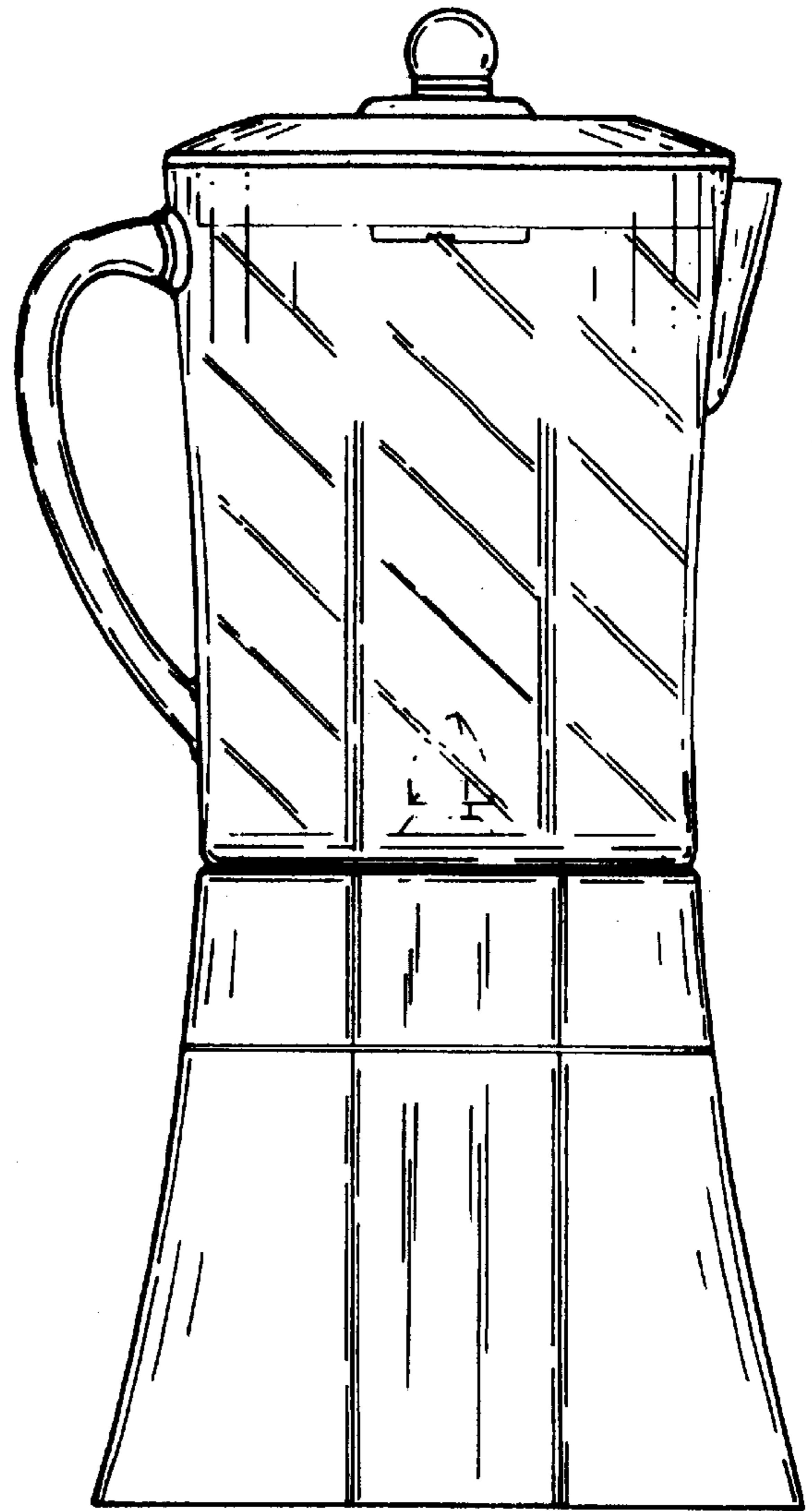

Fig. 3

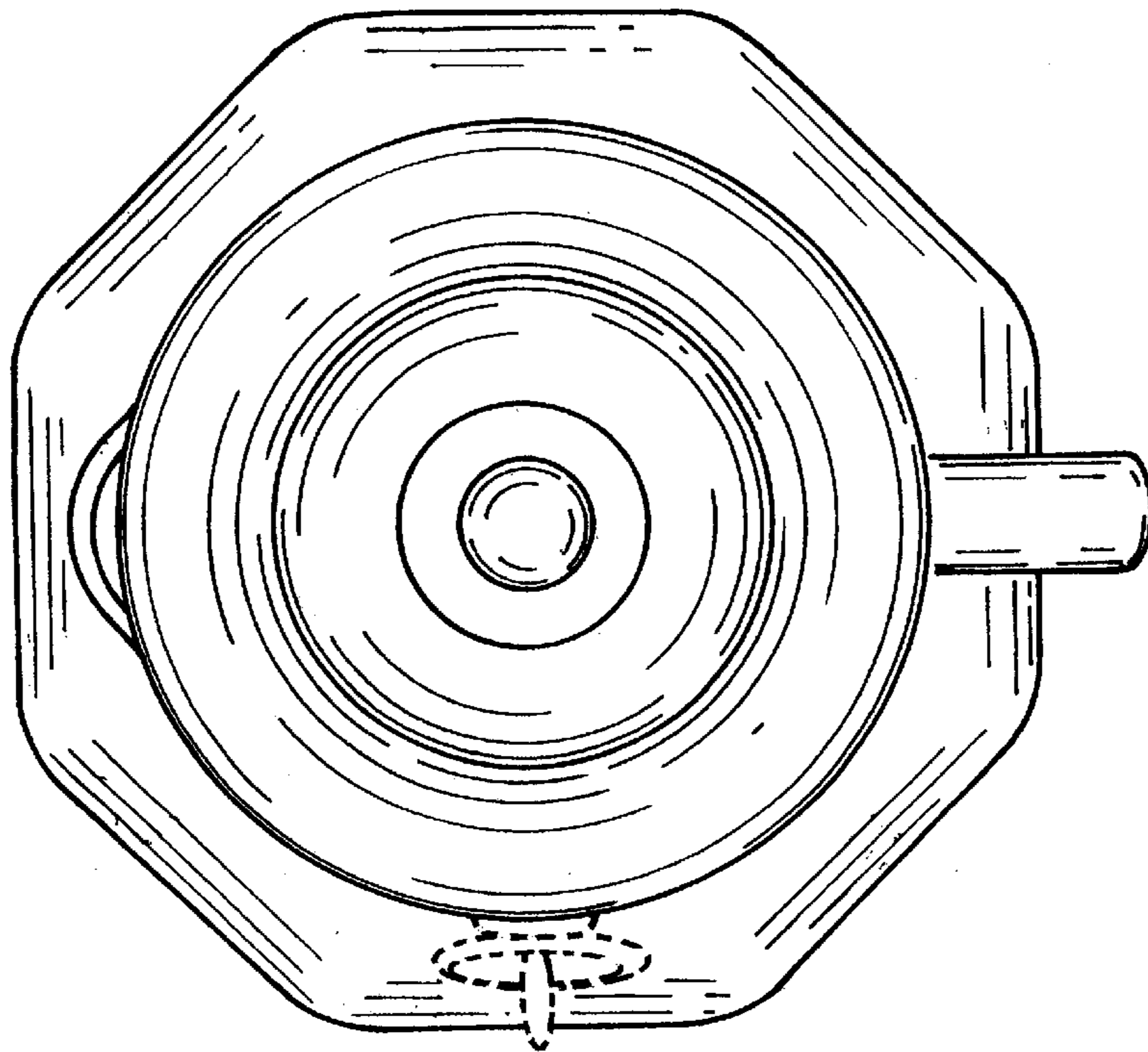

**Fig. 5**

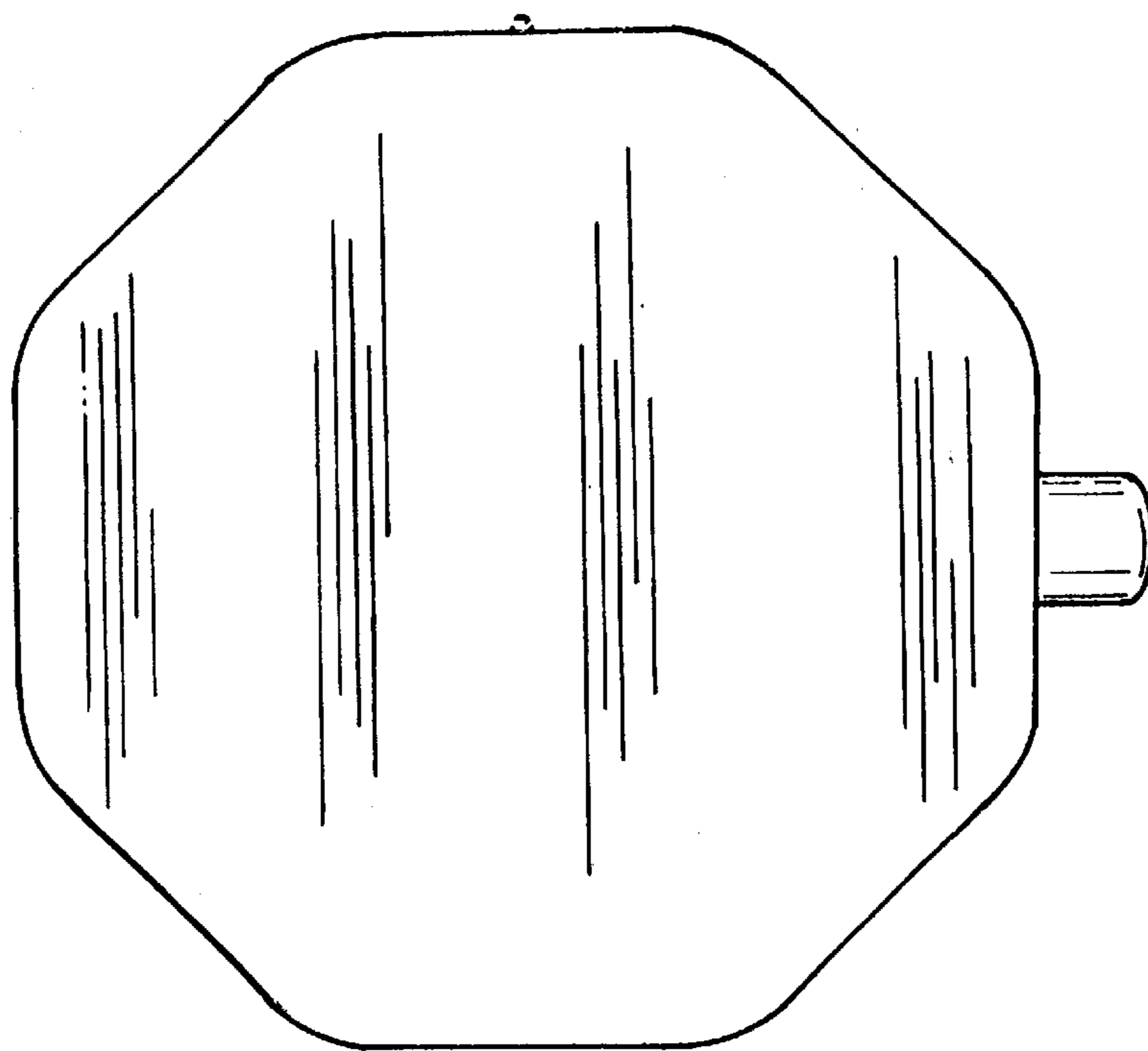

**Fig. 4**





**Fig. 6**



**Fig. 7**