



US00D450505B1

(12) **United States Design Patent**  
**D'Uscio**

(10) **Patent No.:** **US D450,505 S**

(45) **Date of Patent:** **\*\* Nov. 20, 2001**

(54) **DISPENSER**

(75) Inventor: **Gaius D'Uscio**, Gümlingen (CH)

(73) Assignee: **Wet-Dry System-Dewe AG**, Wohlen (CH)

(\*\*) Term: **14 Years**

(21) Appl. No.: **29/134,307**

(22) Filed: **Dec. 20, 2000**

(30) **Foreign Application Priority Data**

Jun. 21, 2000 (XH) ..... DM/052 346

(51) **LOC (7) Cl.** ..... **23-02**

(52) **U.S. Cl.** ..... **D6/545**

(58) **Field of Search** ..... D6/542-545; 222/92,  
222/105, 173, 180, 181.1, 181.3; 221/282-283;  
206/77.1

(56) **References Cited**

**U.S. PATENT DOCUMENTS**

D. 206,994 \* 2/1967 Baker ..... D6/545

D. 277,910 \* 3/1985 Hoyt ..... D6/545

D. 299,198 \* 1/1989 Gregory ..... D6/542

D. 352,626 \* 11/1994 Vignot ..... D6/545

\* cited by examiner

*Primary Examiner*—Brian N. Vinson

(74) *Attorney, Agent, or Firm*—Burns, Doane, Swecker & Mathis, LLP

(57) **CLAIM**

The ornamental design for a dispenser, as shown and described.

**DESCRIPTION**

FIG. 1 is a front perspective view of a dispenser showing my new design;

FIG. 2 is a side elevational view thereof, the other side being a mirror image thereof;

FIG. 3 is a front elevational thereof;

FIG. 4 is a rear elevational view thereof;

FIG. 5 is a bottom plan view thereof; and,

FIG. 6 is a top plan view thereof.

**1 Claim, 2 Drawing Sheets**

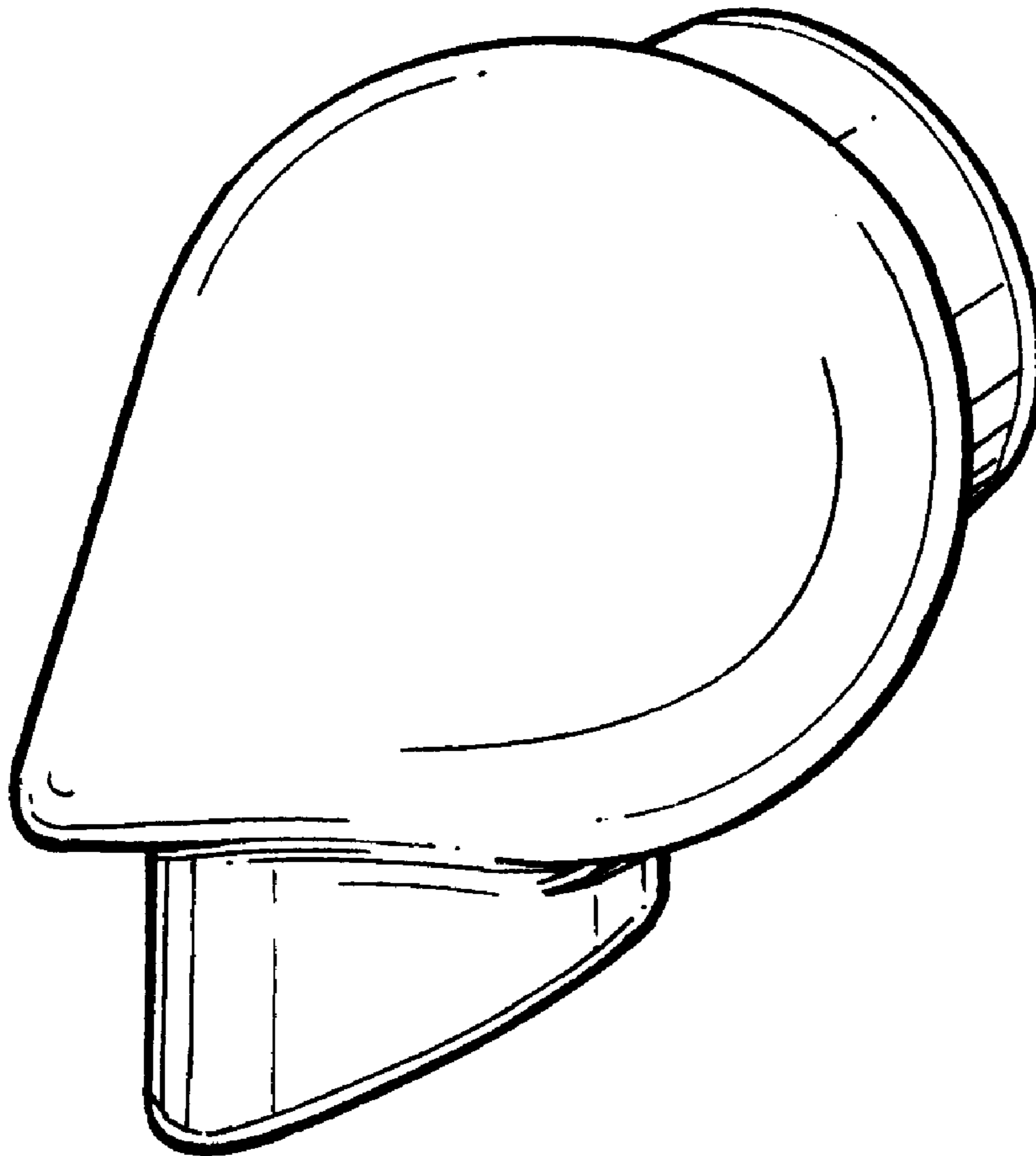

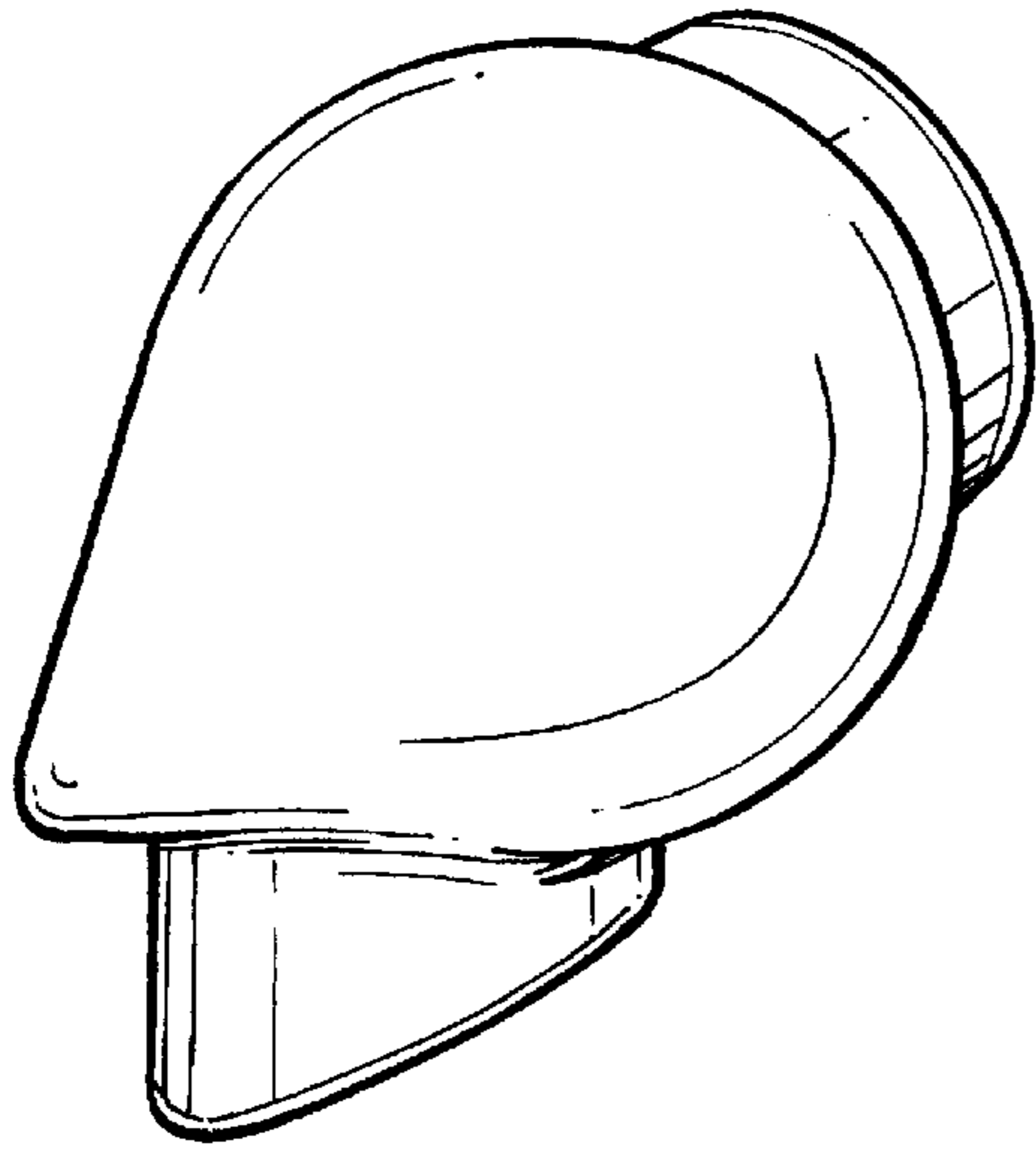

FIG. 1

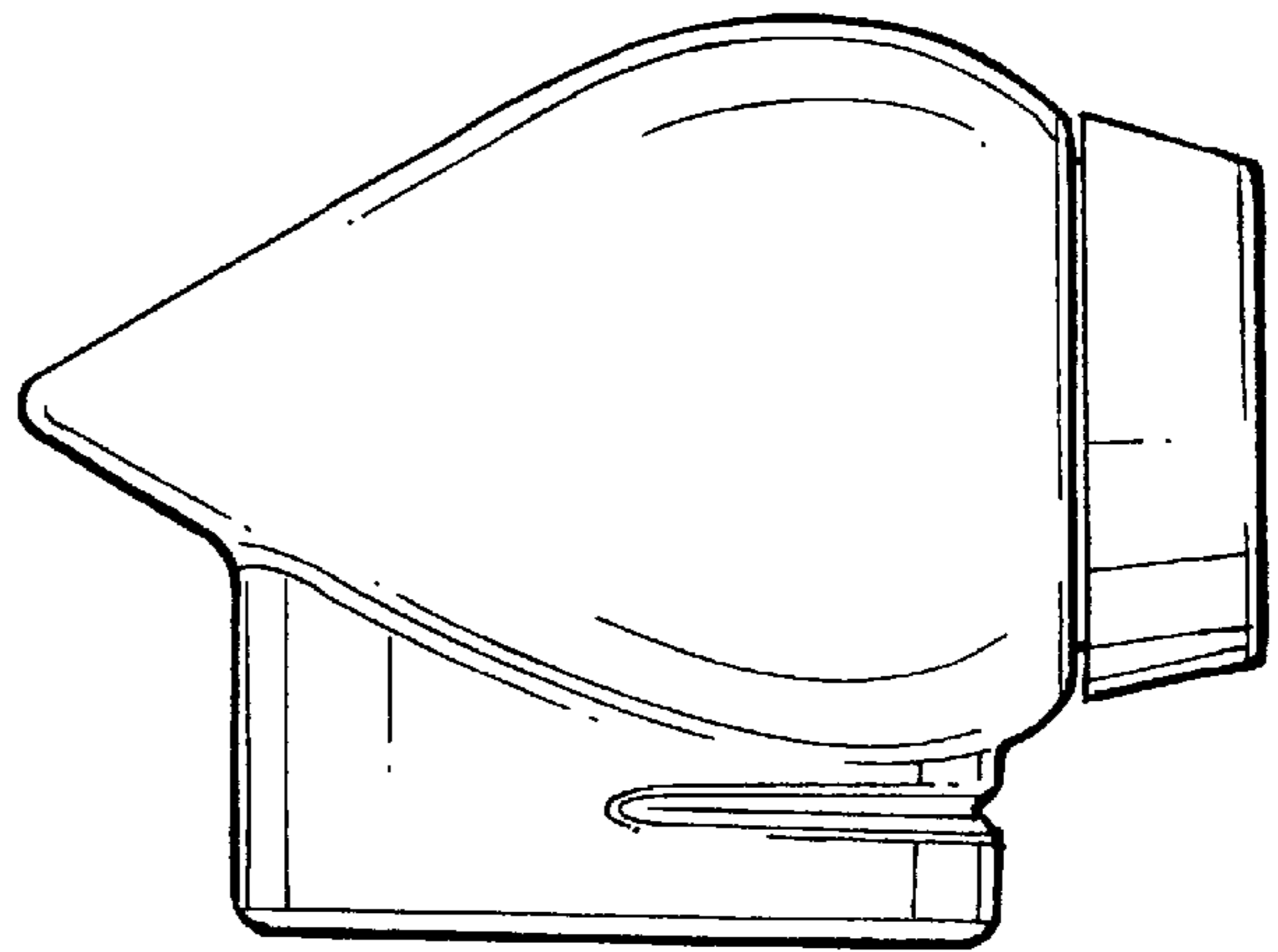

FIG. 2

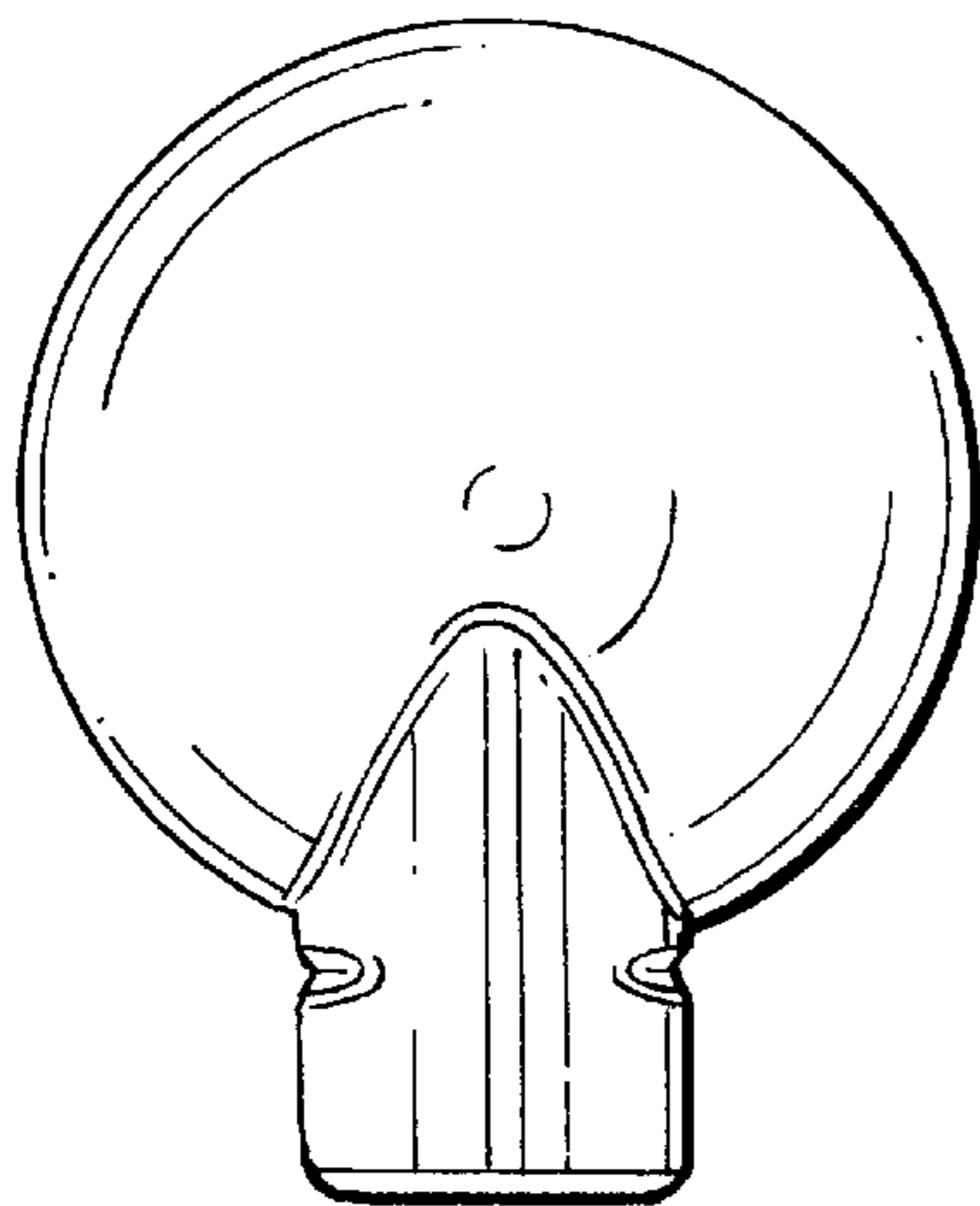

FIG. 3

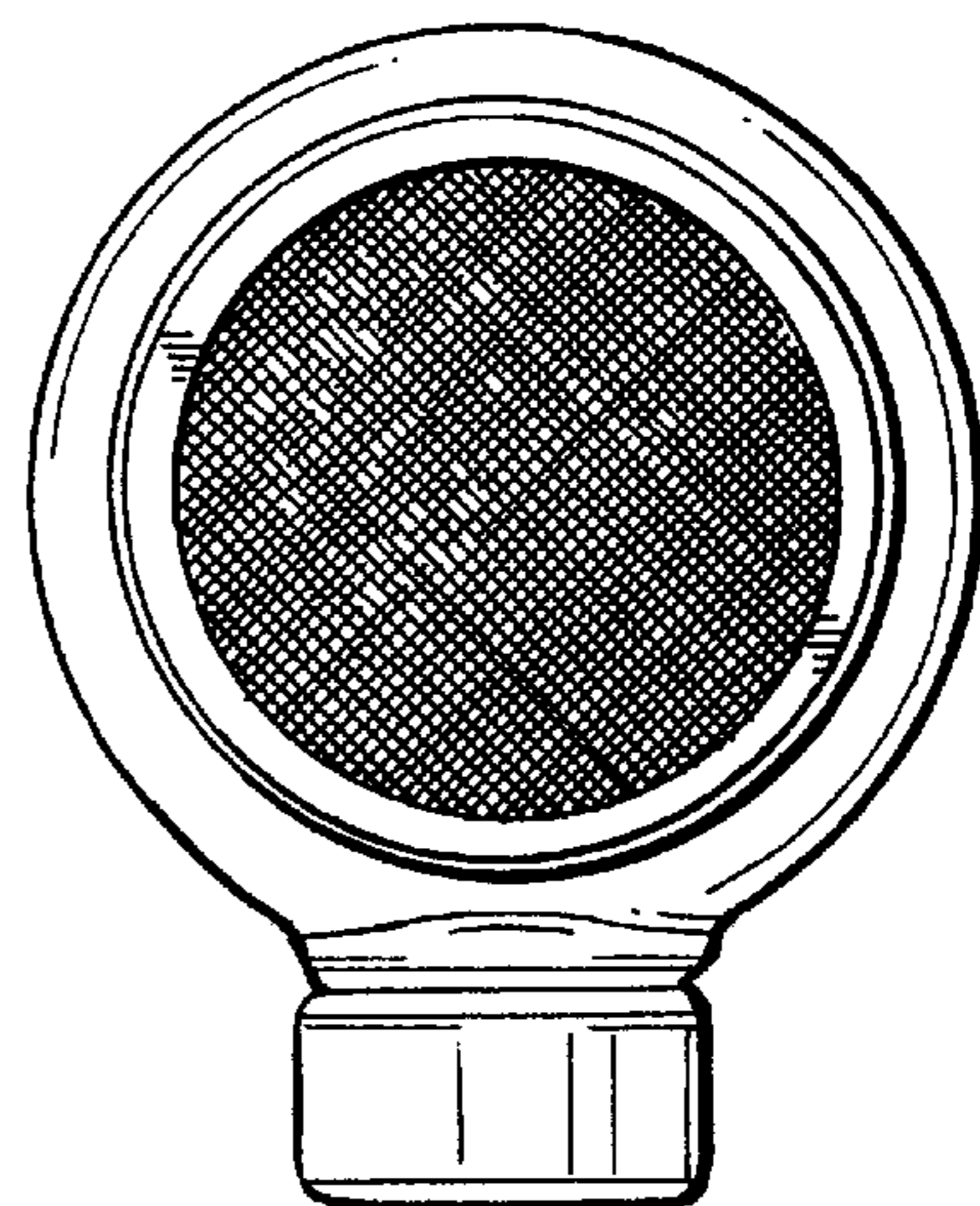

FIG. 4

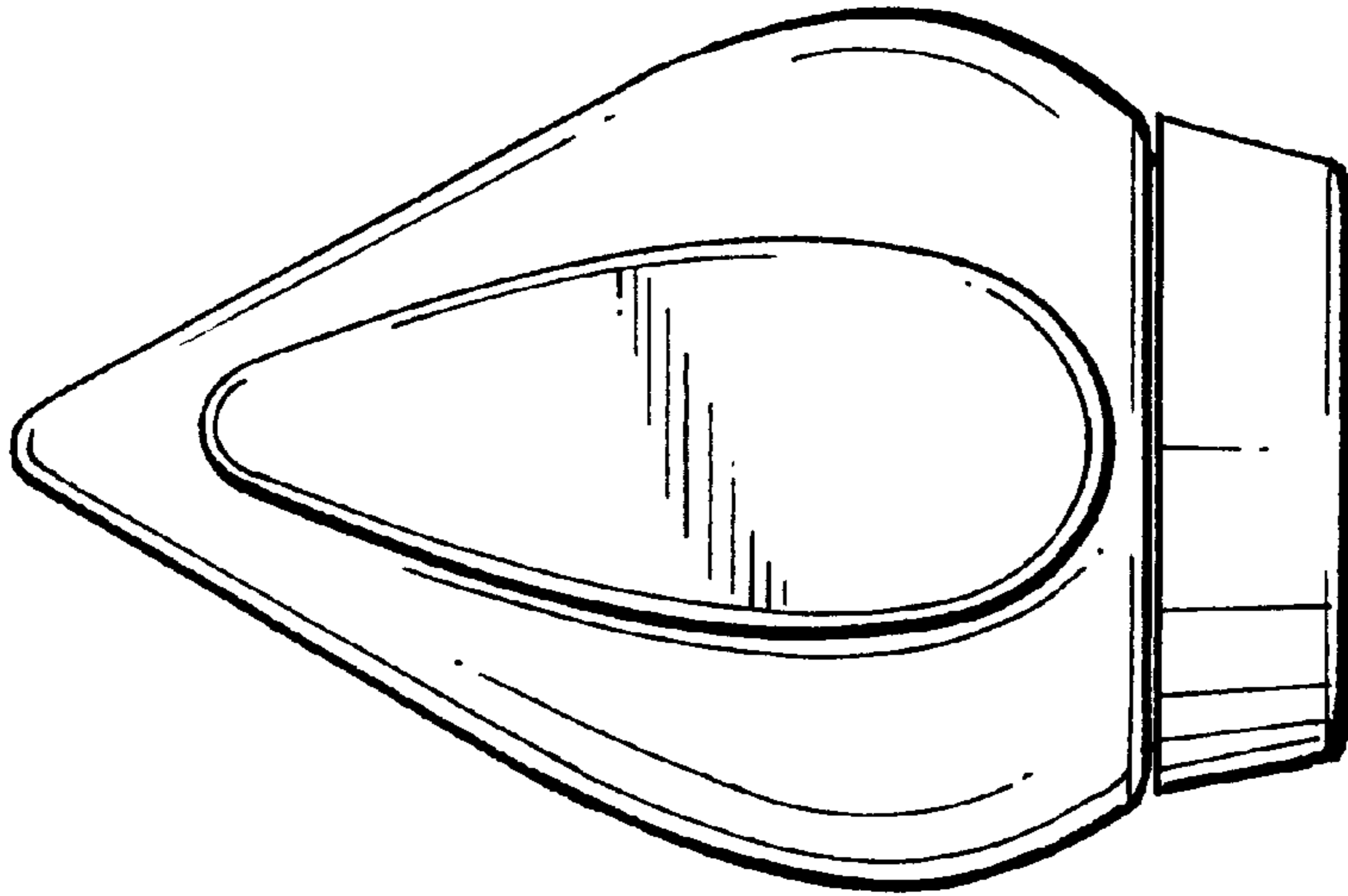

FIG. 5

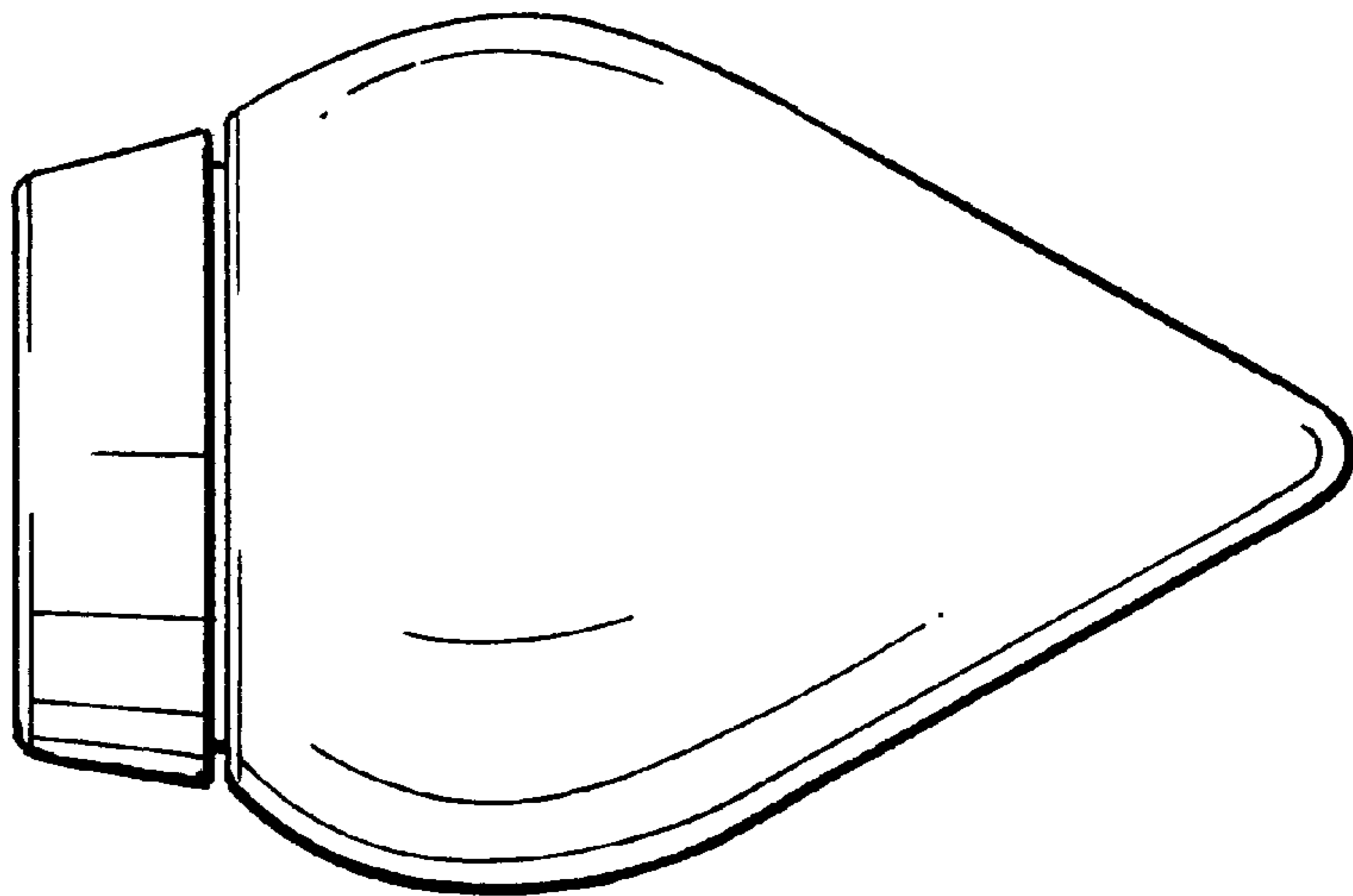

FIG. 6

UNITED STATES PATENT AND TRADEMARK OFFICE  
**CERTIFICATE OF CORRECTION**

PATENT NO. : Des. 450,505 S  
APPLICATION NO. : 29/134307  
DATED : November 20, 2001  
INVENTOR(S) : Gaius D'Uscio

Page 1 of 1

It is certified that error appears in the above-identified patent and that said Letters Patent is hereby corrected as shown below:

On the title page

The assignee is listed incorrectly as:

(73) Assignee: Wet-Dry System-Dewe AG, Wohlen (CH)

The correct assignee is:

(73) Assignee: Dry-Wet System-Dewe AG, Wohlen (CH)

Signed and Sealed this

Sixth Day of May, 2008

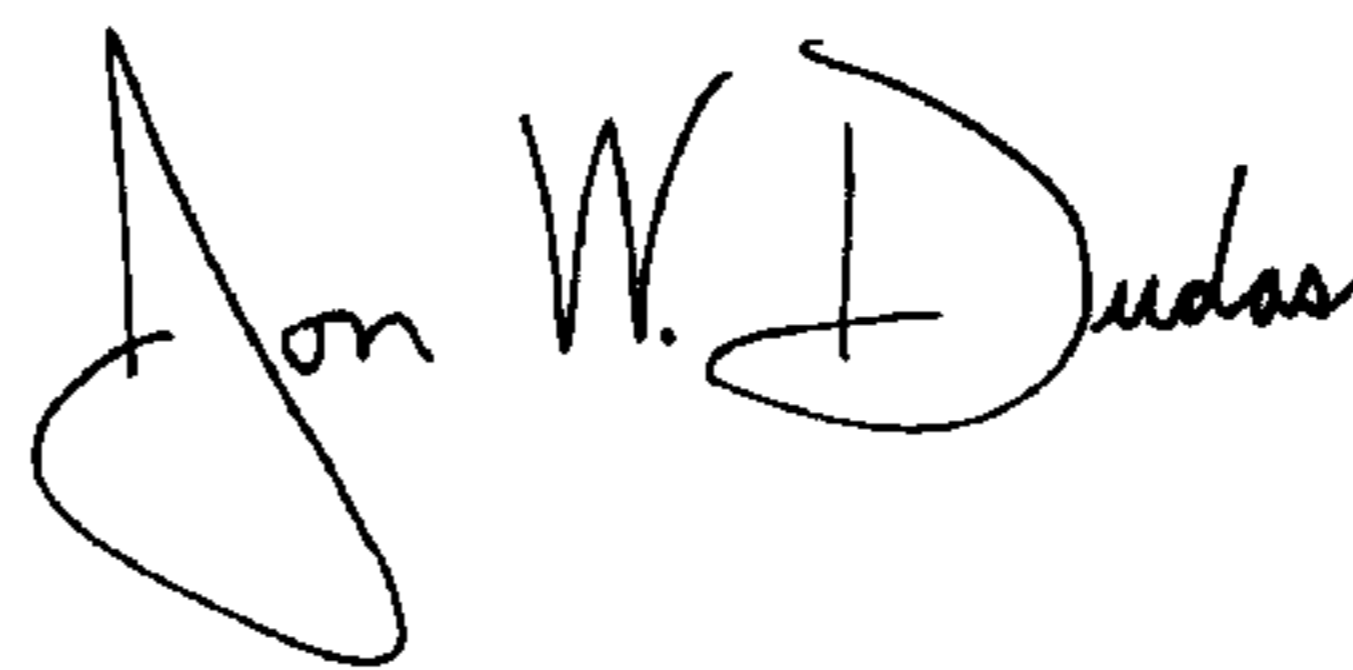
A handwritten signature in black ink that reads "Jon W. Dudas". The signature is written in a cursive style with a large, looped initial "J".

JON W. DUDAS

*Director of the United States Patent and Trademark Office*