



US00D450449B1

(12) **United States Design Patent**
Godshaw et al.

(10) **Patent No.:** **US D450,449 S**

(45) **Date of Patent:** **** Nov. 20, 2001**

(54) **TOOL BELT**

(75) Inventors: **Donald E. Godshaw**, Evanston;
Andrzej M. Redzisz, Skokie, both of
IL (US); **Kirk R. Brown**, Valencia, CA
(US)

(73) Assignee: **Travel Caddy, Inc.**, Des Plaines, IL
(US)

(**) Term: **14 Years**

(21) Appl. No.: **29/108,122**

(22) Filed: **Jul. 21, 1999**

(51) **LOC (7) Cl.** **03-01**

(52) **U.S. Cl.** **D3/228**

(58) **Field of Search** D3/228, 215, 224,
D3/226; 224/904, 240, 241, 245, 252, 678,
660, 676, 677

(56) **References Cited**

U.S. PATENT DOCUMENTS

D. 254,758	*	4/1980	Rodstein	D3/228
D. 348,778	*	7/1994	Dancyger	D3/228
D. 348,983	*	7/1994	Dancyger	D3/228 X
D. 350,849	*	9/1994	Dancyger	D3/228
D. 361,658	*	8/1995	Martin	D3/228
5,609,283	*	3/1997	Harrison, Jr.	224/678

* cited by examiner

Primary Examiner—Louis S. Zarfaz
Assistant Examiner—Catherine R. Oliver
(74) *Attorney, Agent, or Firm*—Banner & Witcoff

(57) **CLAIM**

The ornamental design for a tool belt, as shown.

DESCRIPTION

FIG. 1 is a front perspective view of the tool belt showing our new design;
FIG. 2 is a rear perspective view;
FIG. 3 is a plan view of the tool belt in the open position viewed from the outside of the belt;
FIG. 4 a plan view of the tool belt in the open position from the inside and opposite the side depicted in FIG. 3;
FIG. 5 is a top plan view of the tool belt of FIG. 3;
FIG. 6 is a bottom plan view of the tool belt of FIG. 3;
FIG. 7 is a side view of the tool belt as viewed from the buckle end of the belt in FIG. 3 depicting a pocket section of the design of the tool belt;
FIG. 8 is a side view of the tool belt as viewed in FIG. 3 at the opposite end from the view of FIG. 7;
FIG. 9 is a side view taken along the line 9—9 in FIG. 3; and,
FIG. 10 is a side view taken along the line 10—10 in FIG. 3.

1 Claim, 5 Drawing Sheets

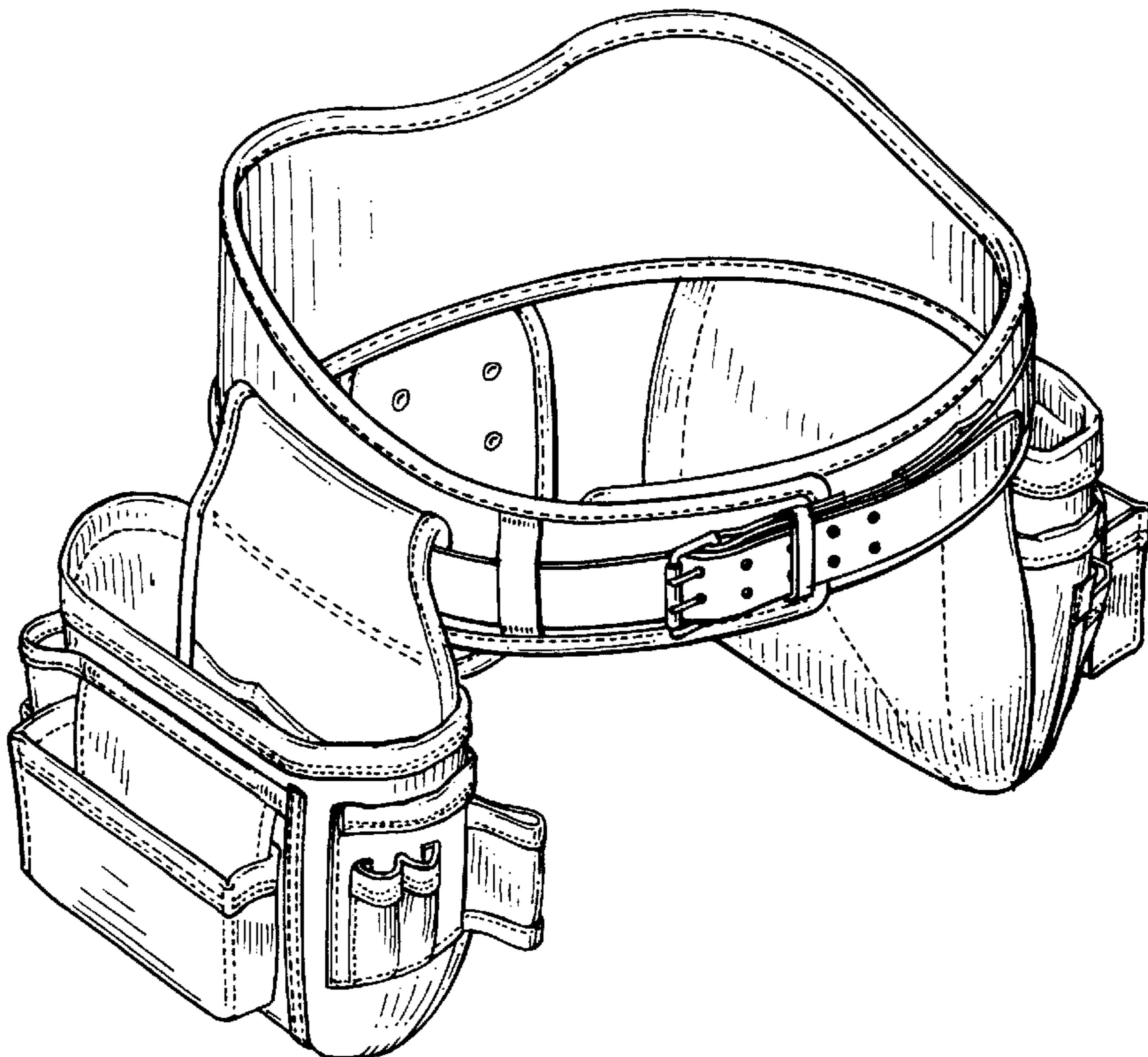

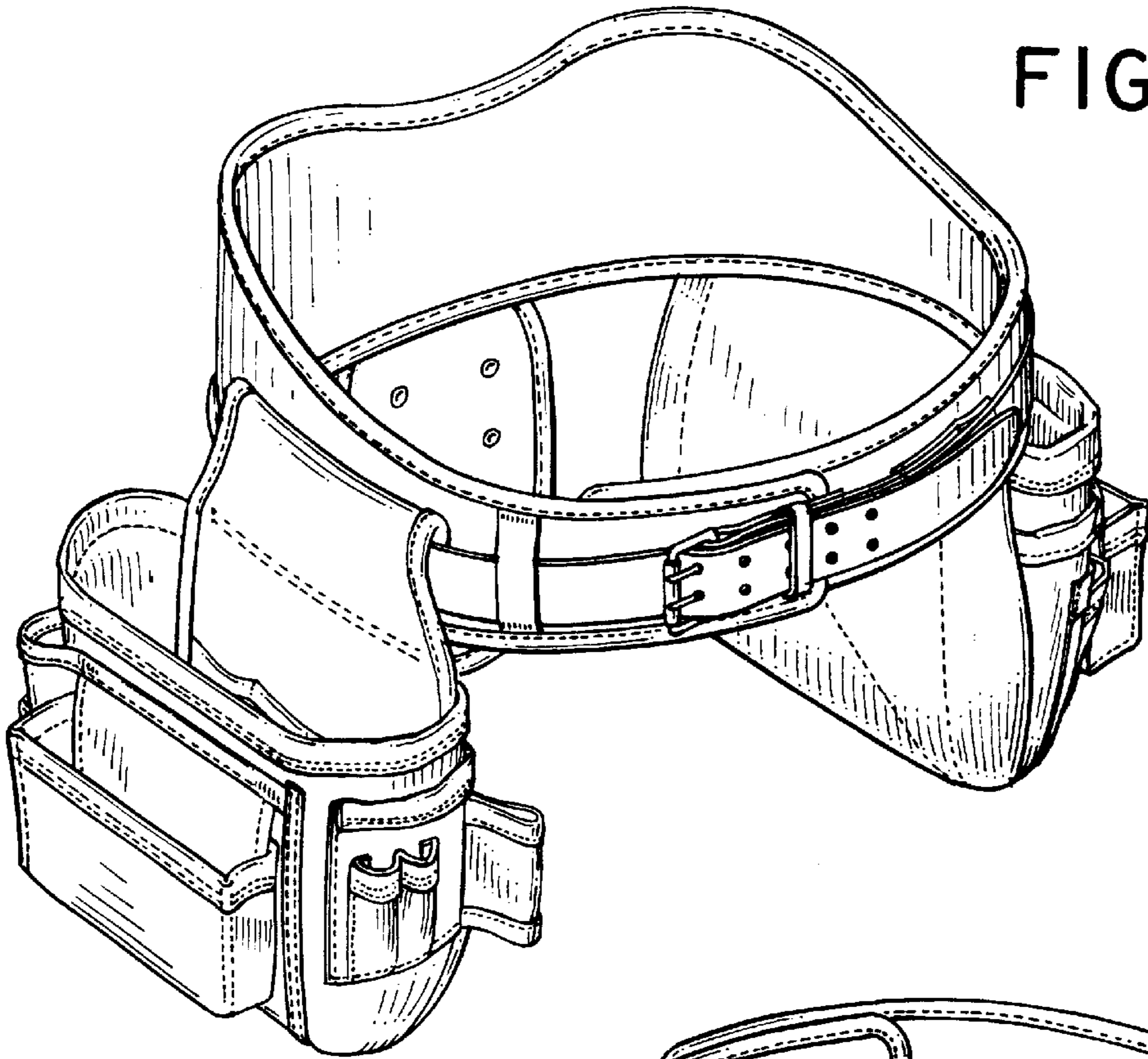

FIG. 1

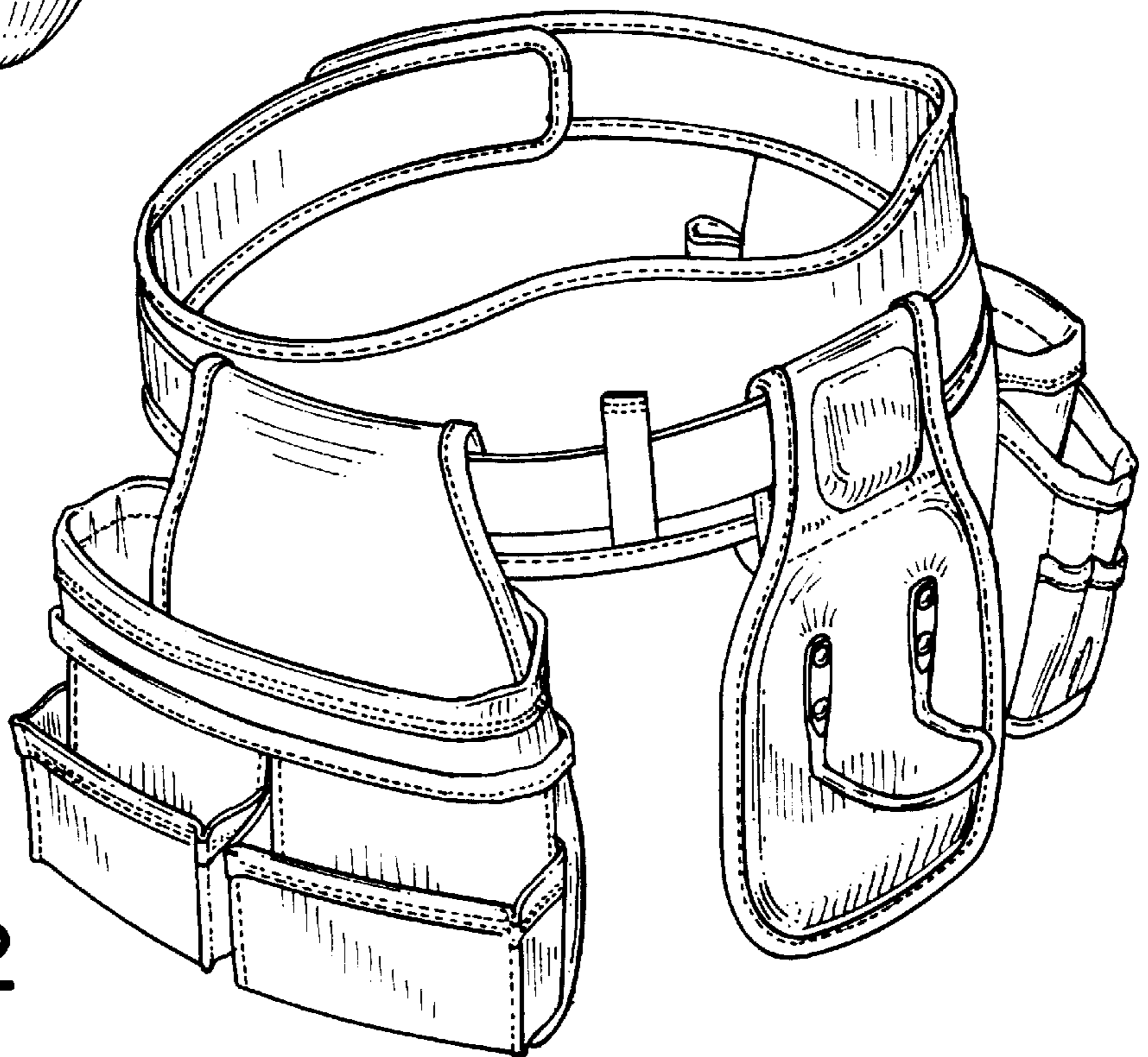

FIG. 2

FIG. 3

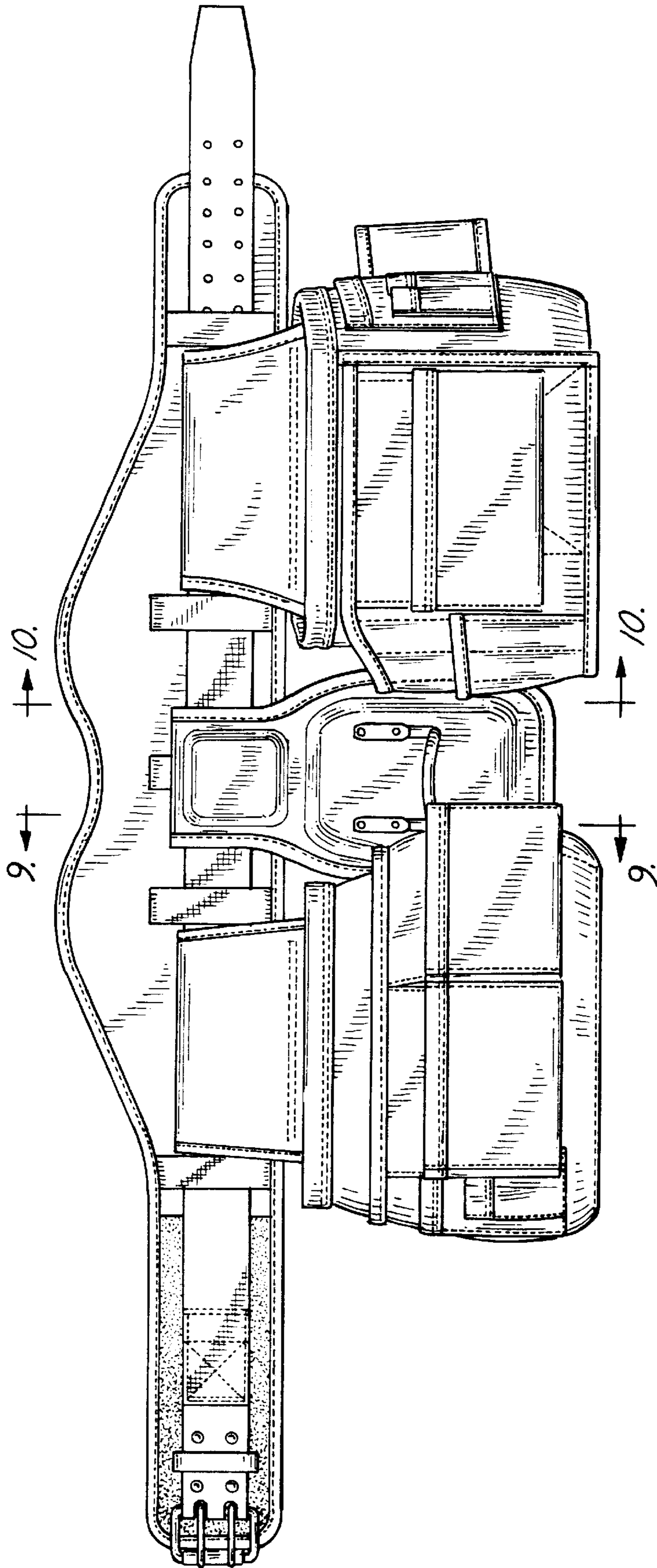

FIG.4

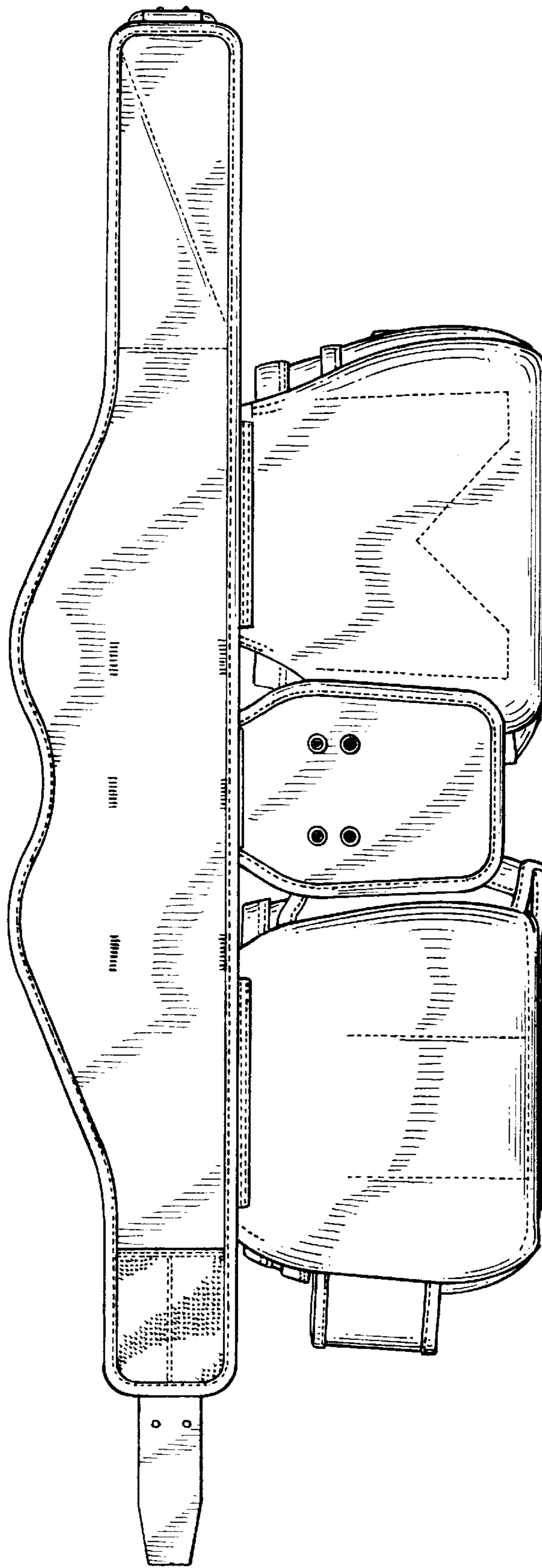

FIG. 5

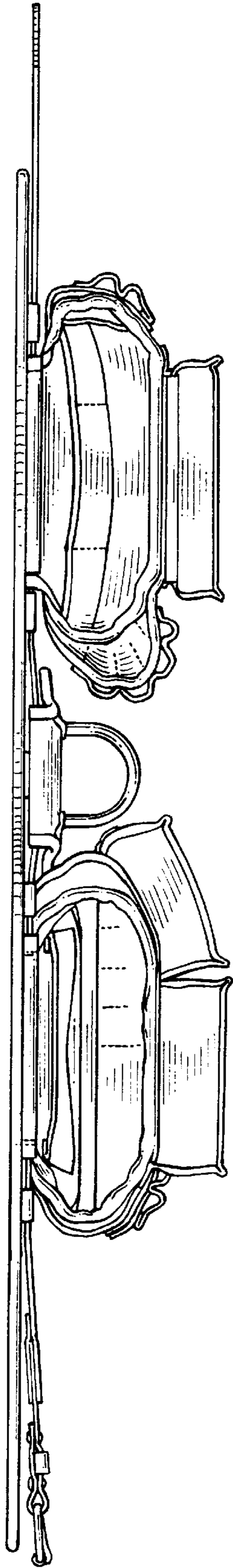

FIG. 6

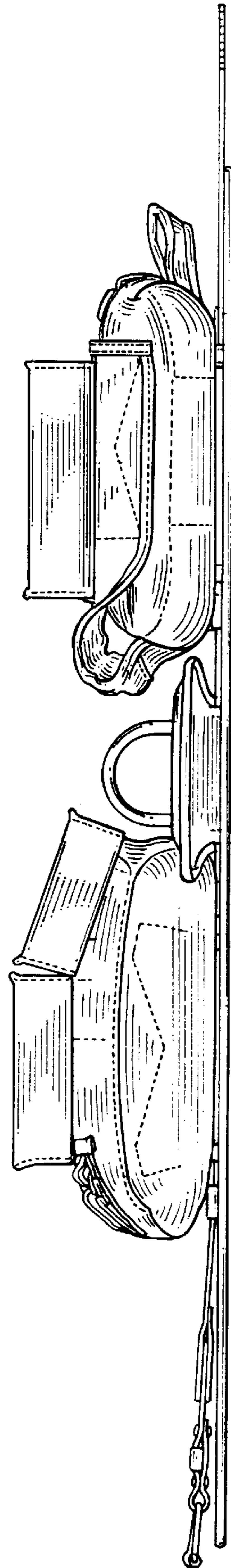

FIG. 7

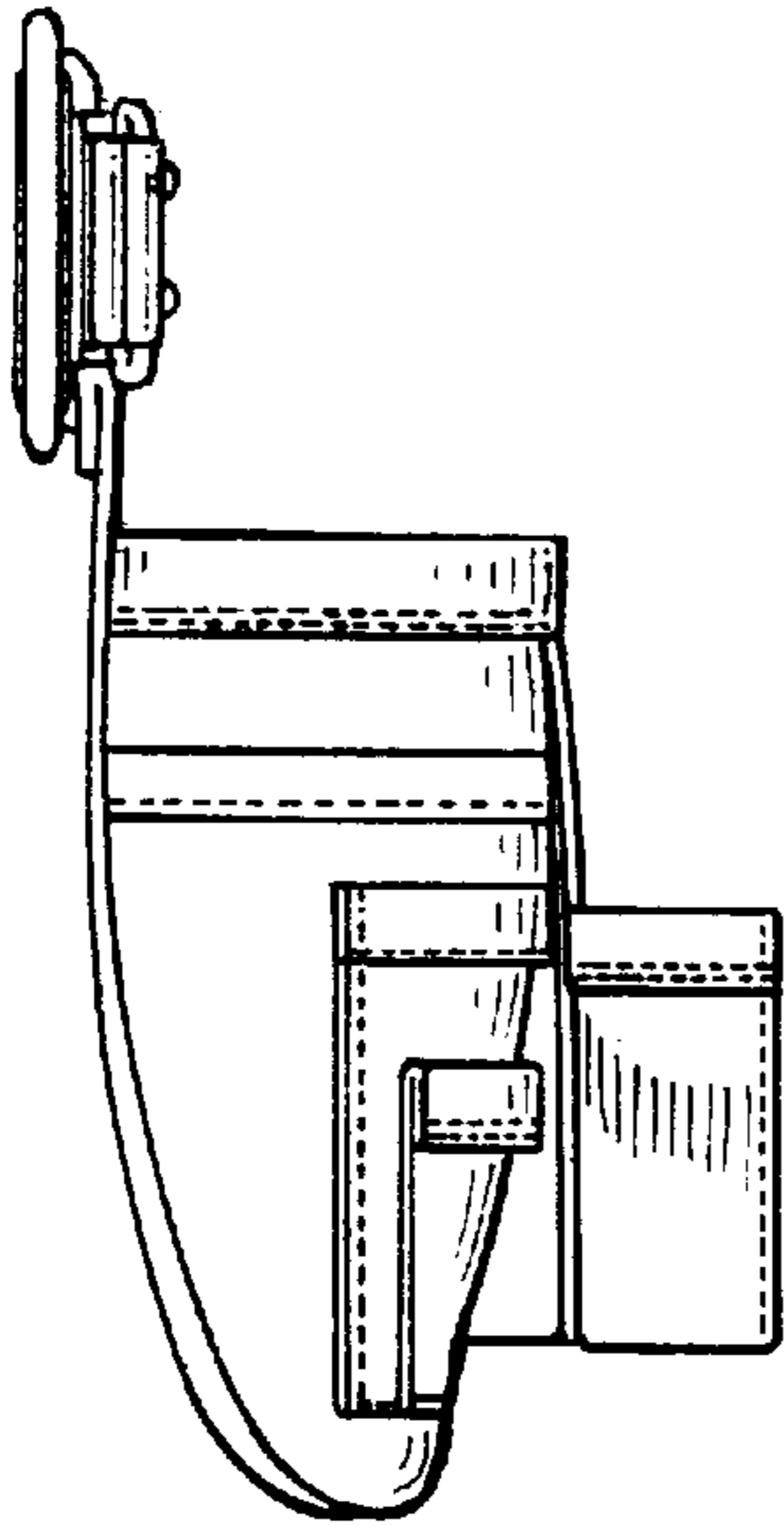

FIG. 8

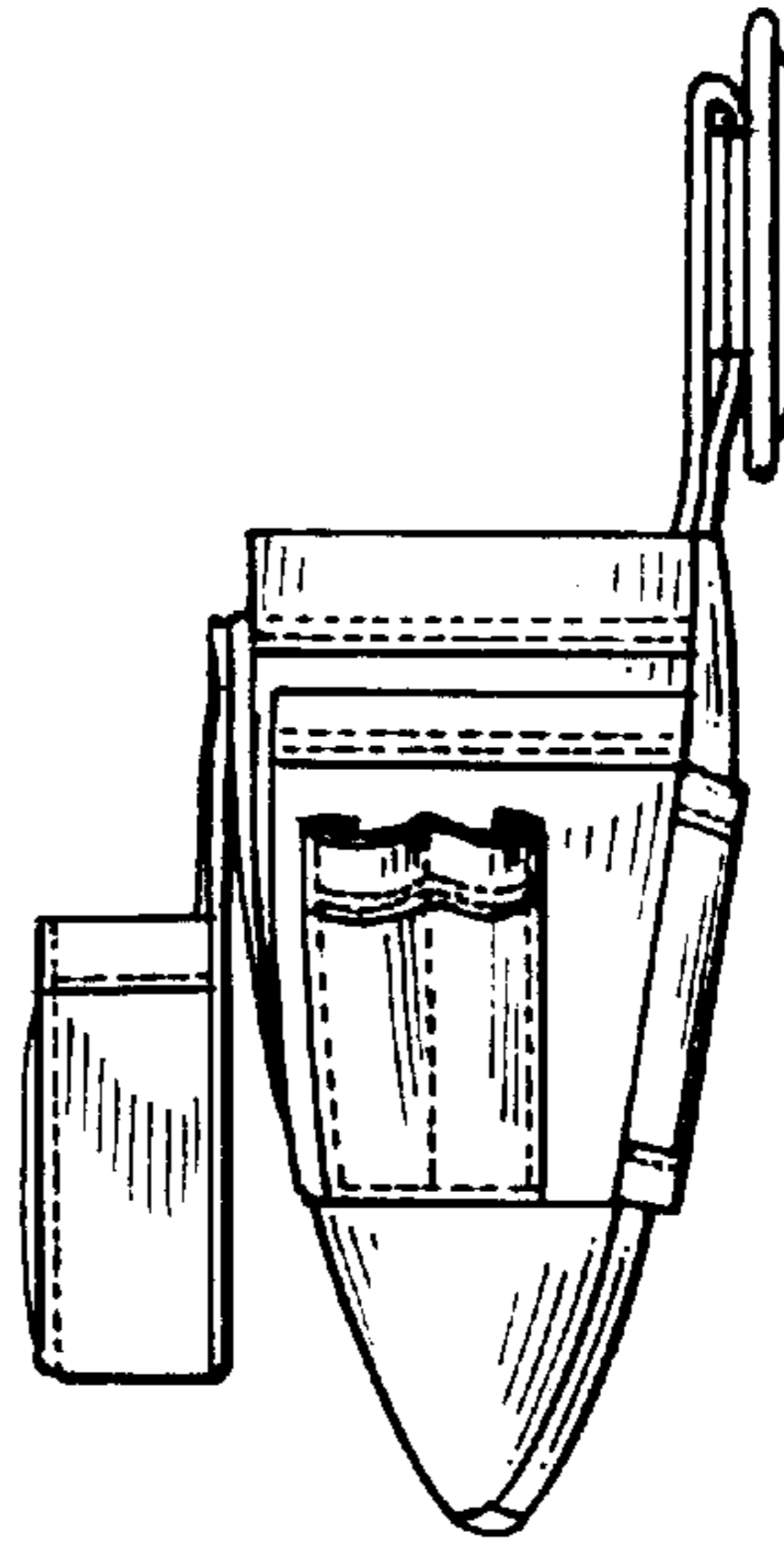

FIG. 9

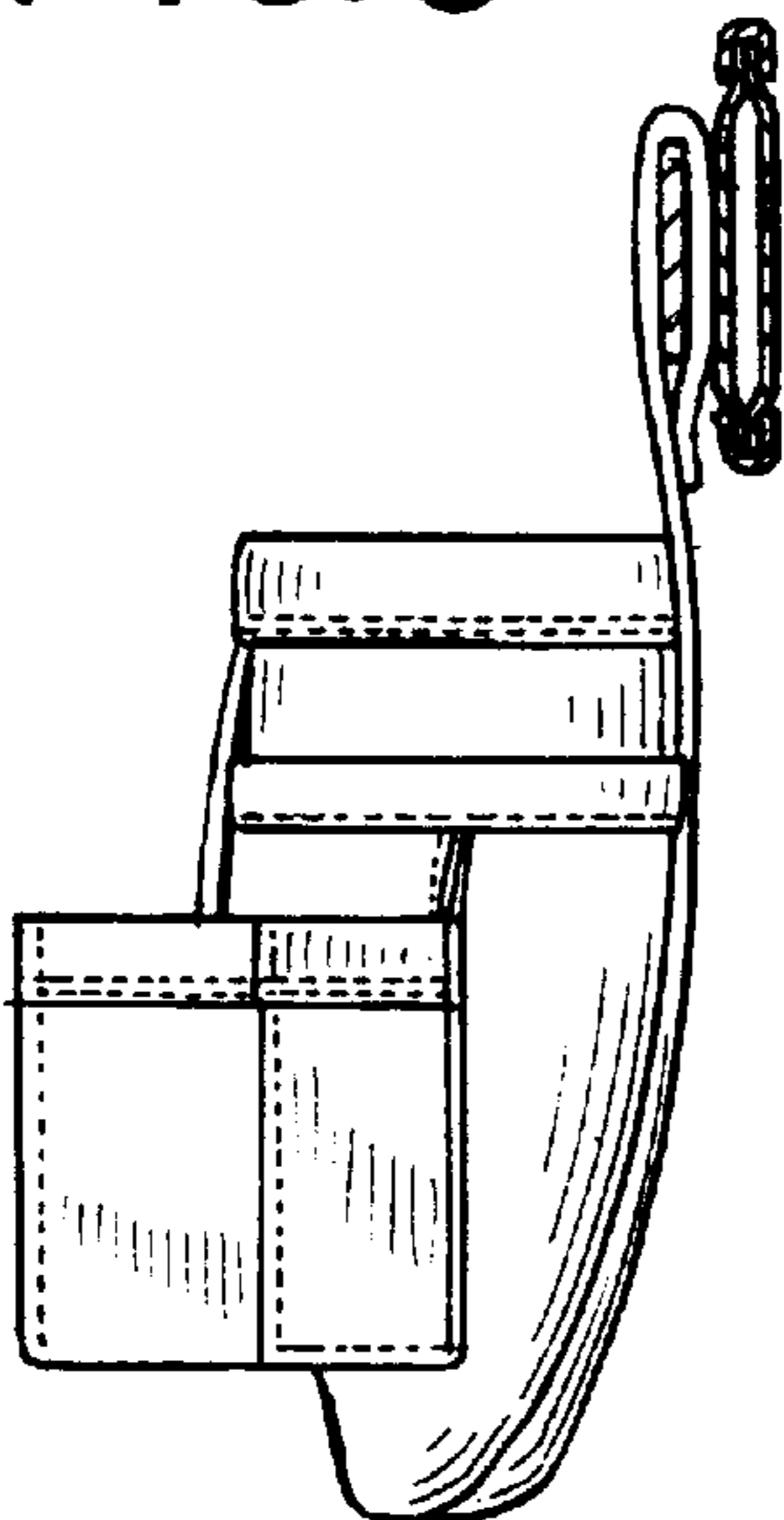

FIG. 10

