



US00D450448B1

(12) **United States Design Patent**
Pierce et al.

(10) **Patent No.:** **US D450,448 S**

(45) **Date of Patent:** **** Nov. 20, 2001**

(54) **RECONFIGURABLE BACKPACK AND
WAIST POUCH**

(76) Inventors: **Kenneth L. Pierce; Vicki L. Pierce,**
both of 337 Stanford Ct., Irvine, CA
(US) 92612

(**) Term: **14 Years**

(21) Appl. No.: **29/120,570**

(22) Filed: **Jan. 29, 2001**

(51) **LOC (7) Cl.** **03-01**

(52) **U.S. Cl.** **D3/217; D3/216**

(58) **Field of Search** **D3/216, 217, 233;**
224/153, 578, 579, 636, 653, 577, 575,
240, 627, 576, 586; 297/4

(56) **References Cited**

U.S. PATENT DOCUMENTS

D. 340,573	*	10/1993	Badeau et al.	D3/217
D. 386,300	*	11/1997	Kopel	D3/233
D. 412,787	*	8/1999	Young	D3/283
D. 420,792	*	2/2000	Sakelliou et al.	D3/216
4,018,369	*	4/1977	Jaeger	224/582
4,029,243	*	6/1977	Zerobnick et al.	224/681
4,515,300	*	5/1985	Cohen	224/153
4,925,070	*	5/1990	Tulgan	224/627
5,150,824	*	9/1992	Alvarez et al.	224/586
5,524,956	*	6/1996	Moore	297/4
5,570,824	*	11/1996	Lyon et al.	224/240

5,673,836	*	10/1997	Bush	224/576
5,797,529	*	8/1998	Lavine	224/575
5,829,653	*	11/1998	Kaiser	224/577
5,887,770	*	3/1999	Covell	224/153
5,934,527	*	8/1999	Neumann	224/153
5,964,384	*	10/1999	Young	224/153

* cited by examiner

Primary Examiner—Celia Murphy

(74) *Attorney, Agent, or Firm*—Roy A. Ekstrand

(57) **CLAIM**

We claim the ornamental design for a reconfigurable backpack and waist pouch, as shown and described.

DESCRIPTION

FIG. 1 is a rear elevational view of a reconfigurable backpack and waist pouch showing our new design configured as a backpack;

FIG. 2 is a front view thereof;

FIG. 3 is a top view thereof;

FIG. 4 is a bottom view thereof;

FIG. 5 is a right side elevational view thereof, the left side being a mirror image;

FIG. 6 is a perspective view thereof; and,

FIG. 7 is a perspective view thereof, configured as a waist pouch.

The broken lines shown throughout the views are understood to represent stitching.

1 Claim, 2 Drawing Sheets

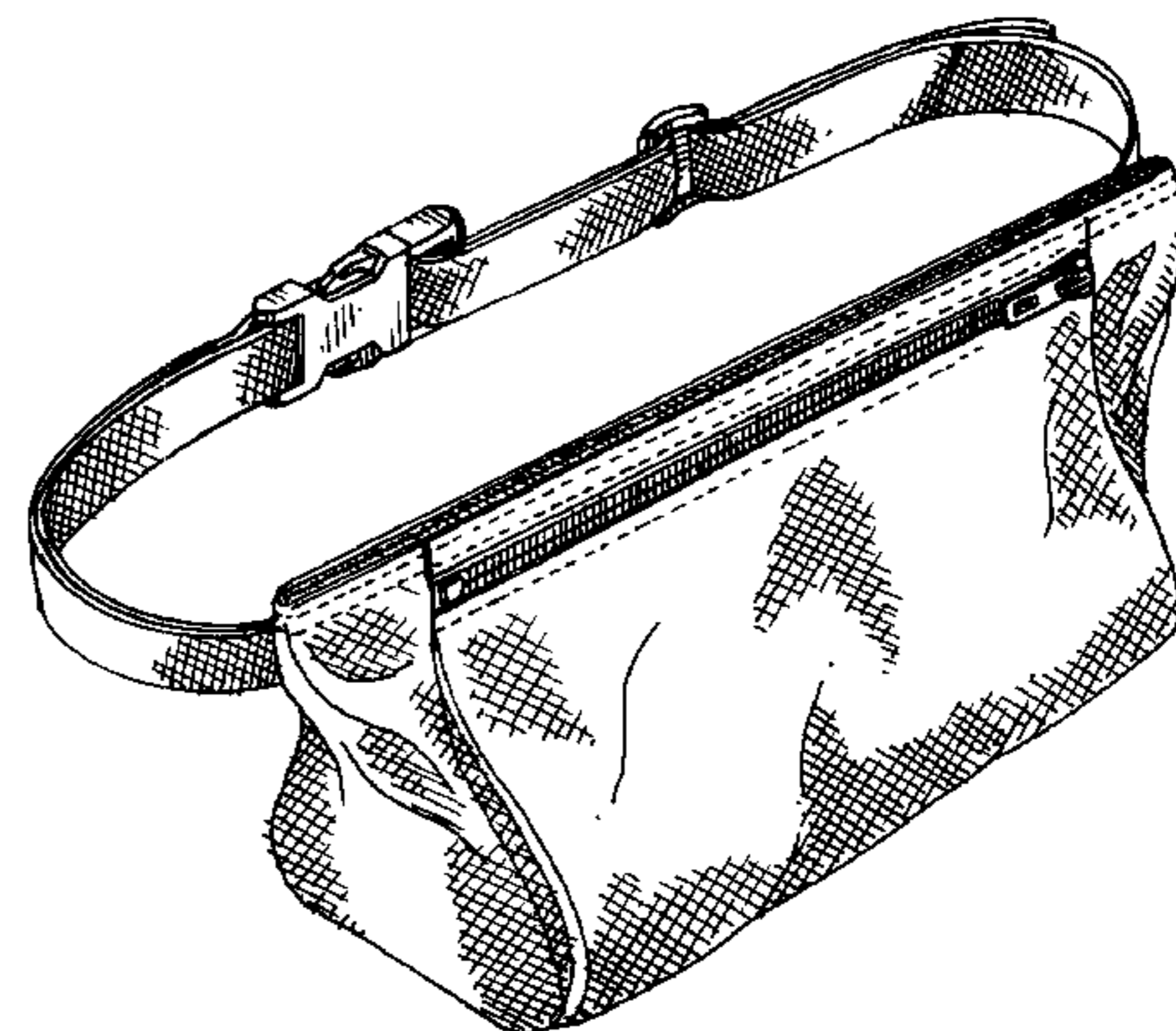
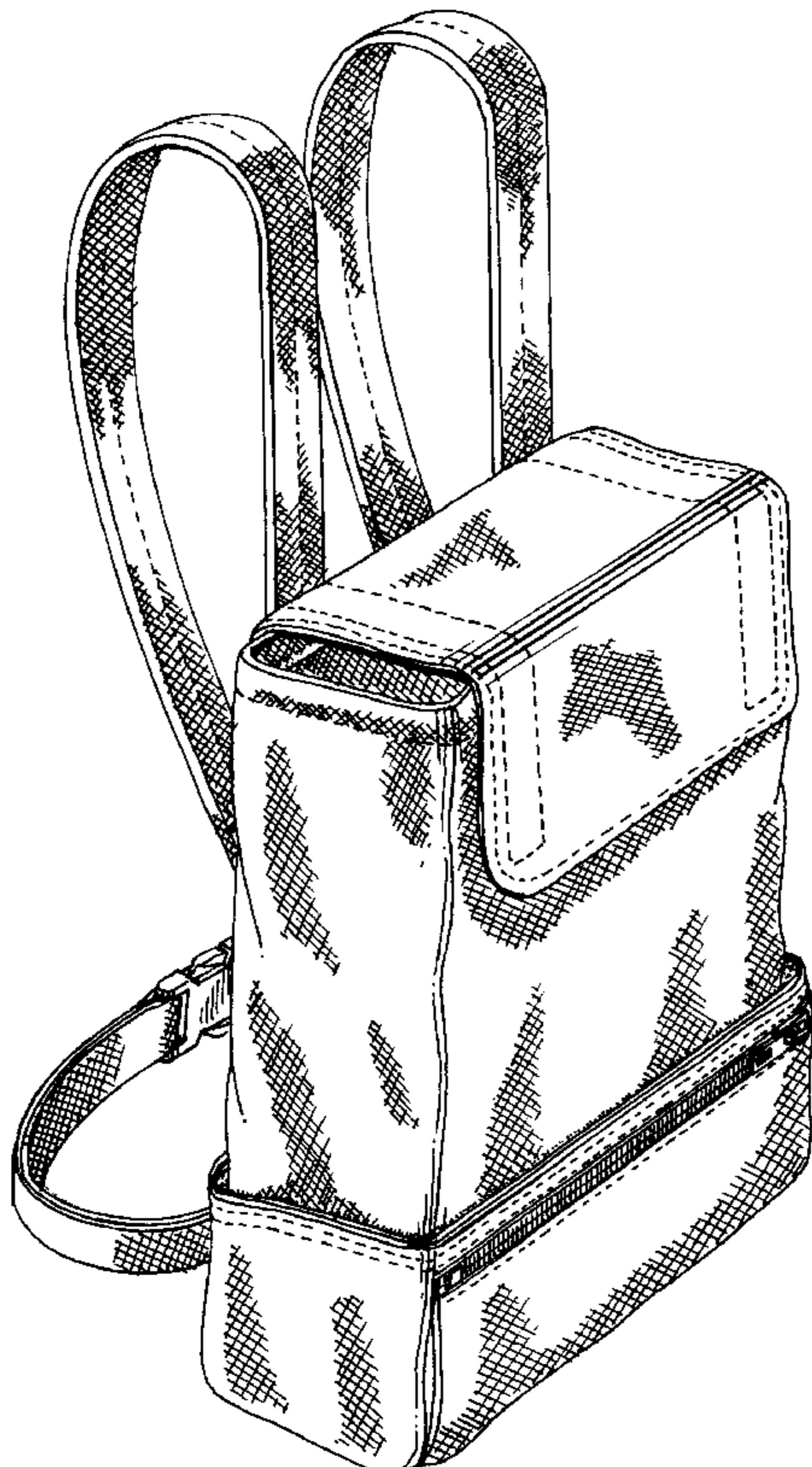

FIG. 1

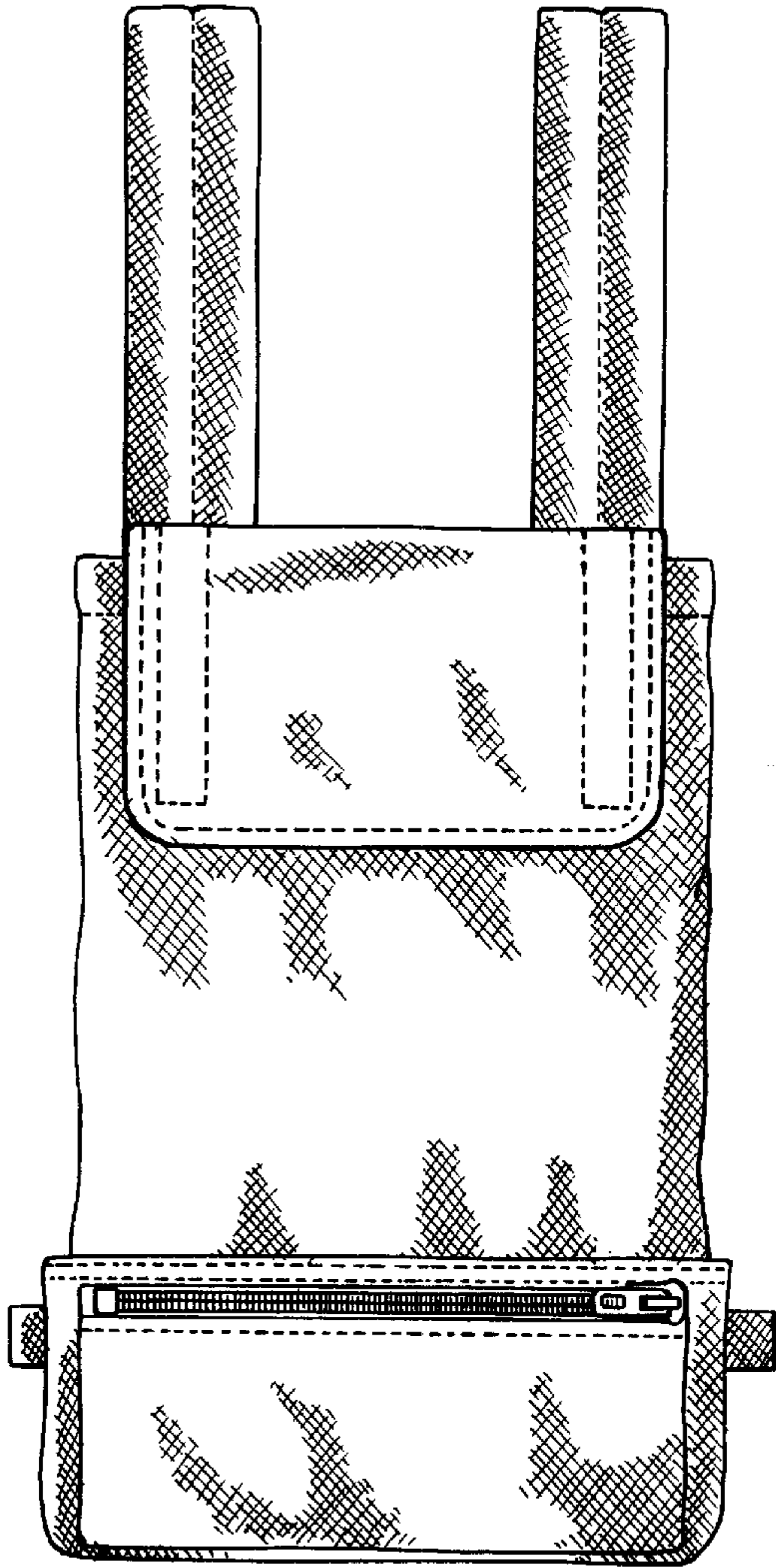

FIG. 2

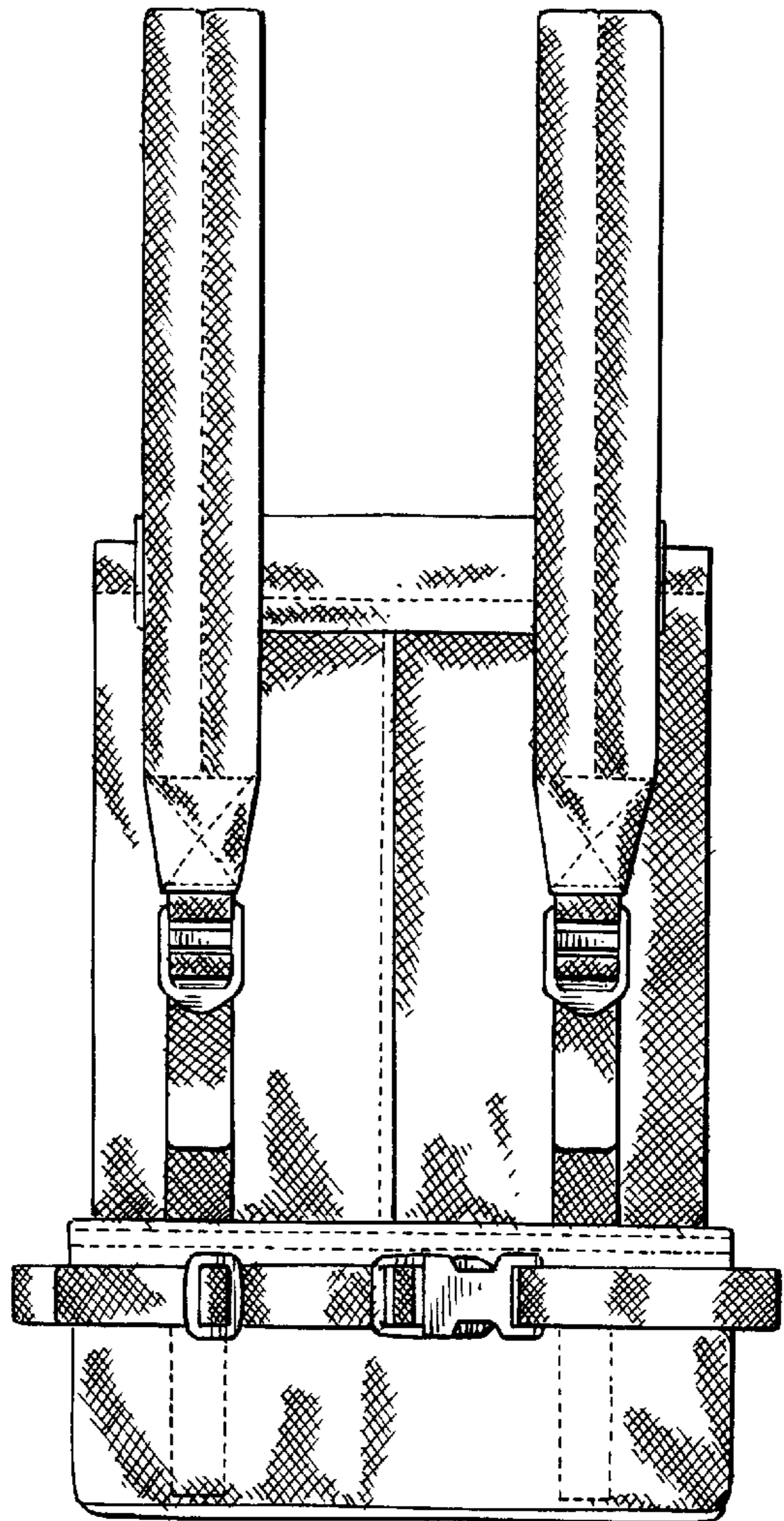

FIG. 3

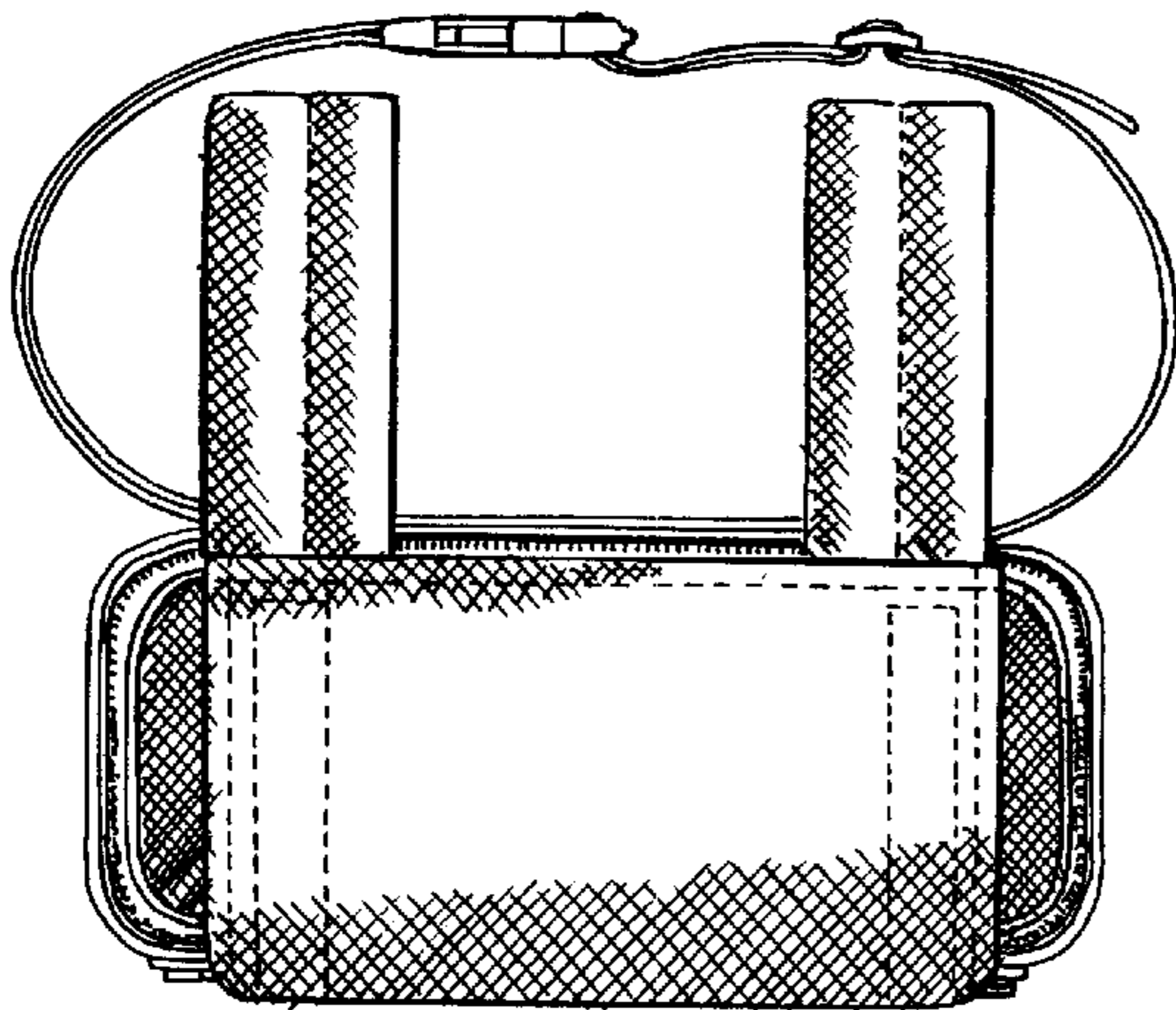

FIG. 4

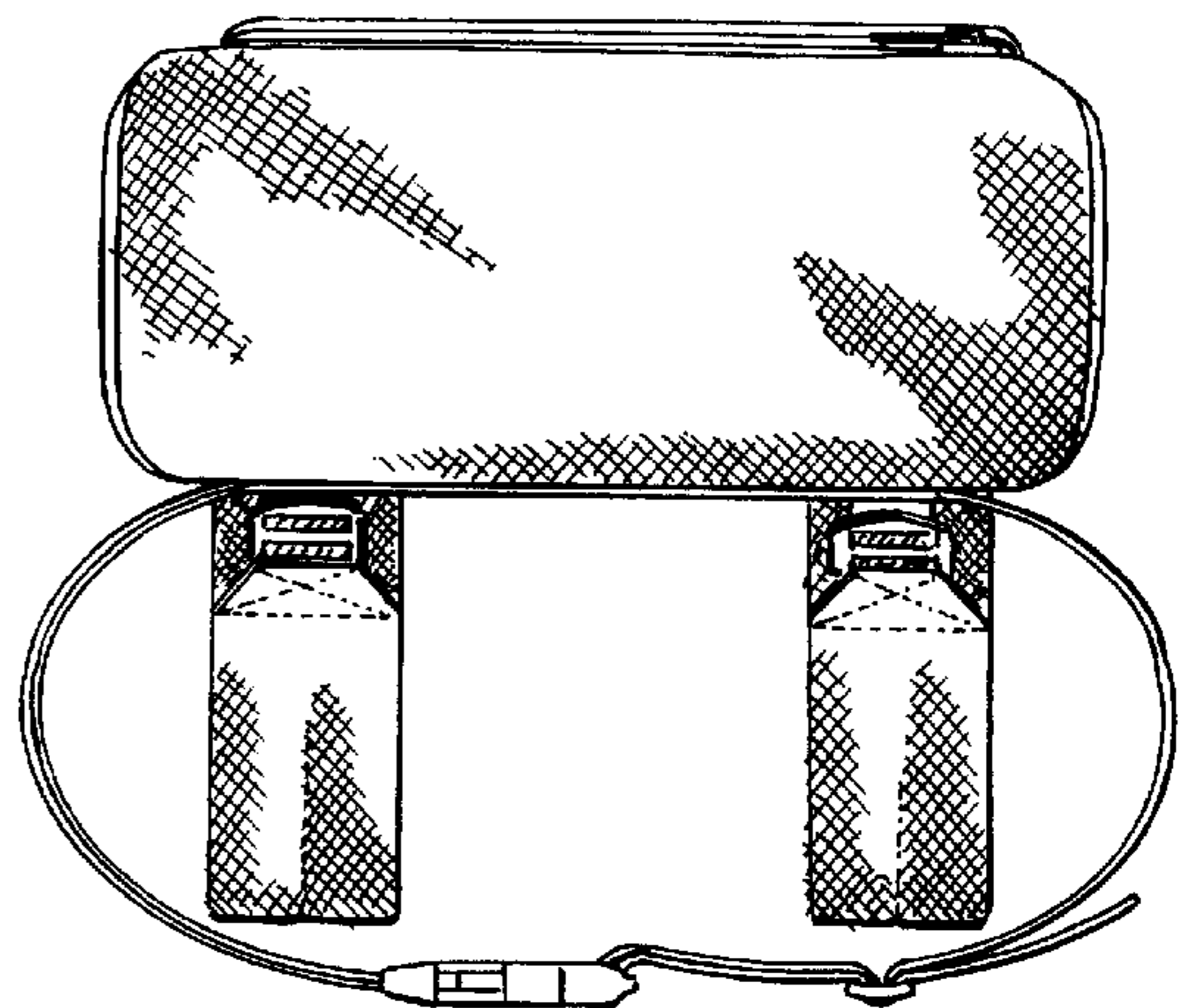

FIG. 5

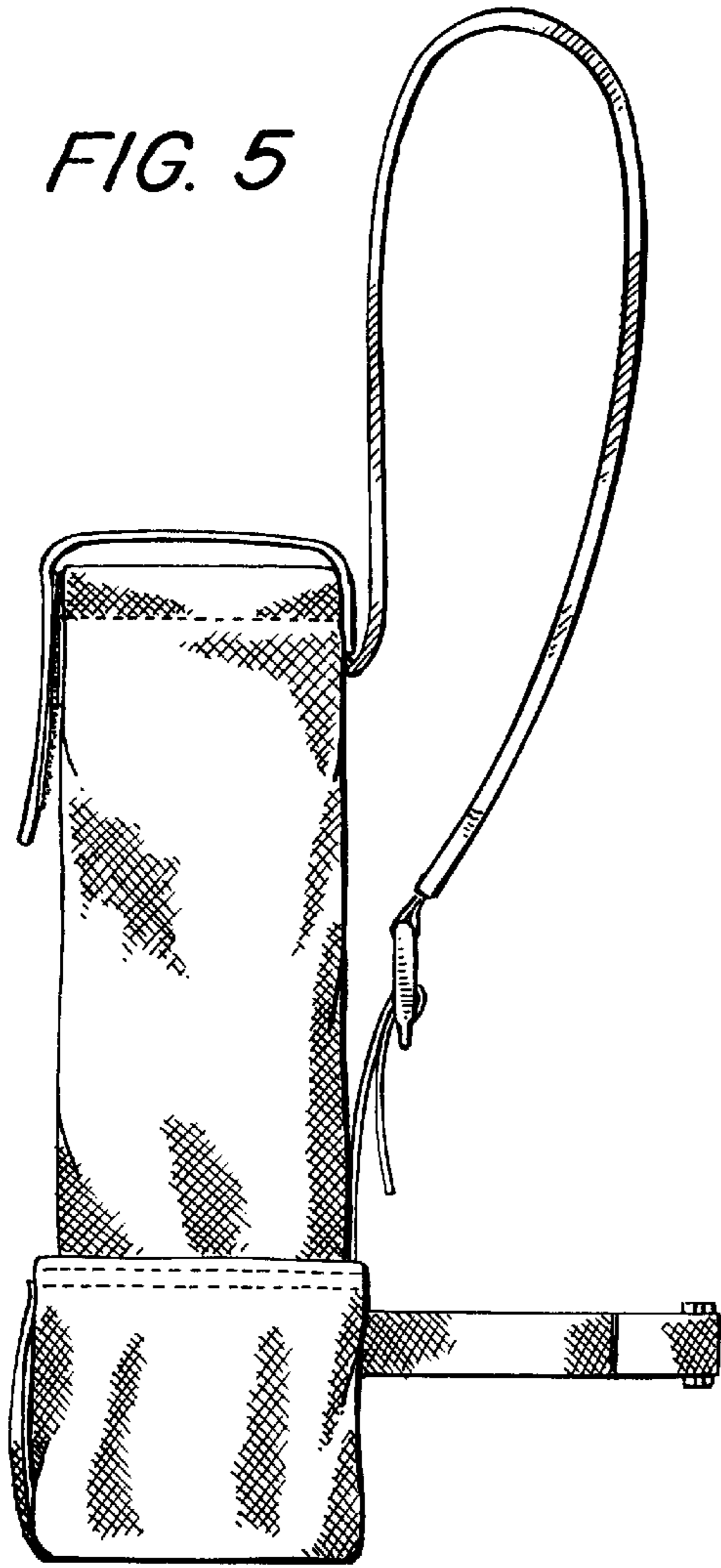

FIG. 6

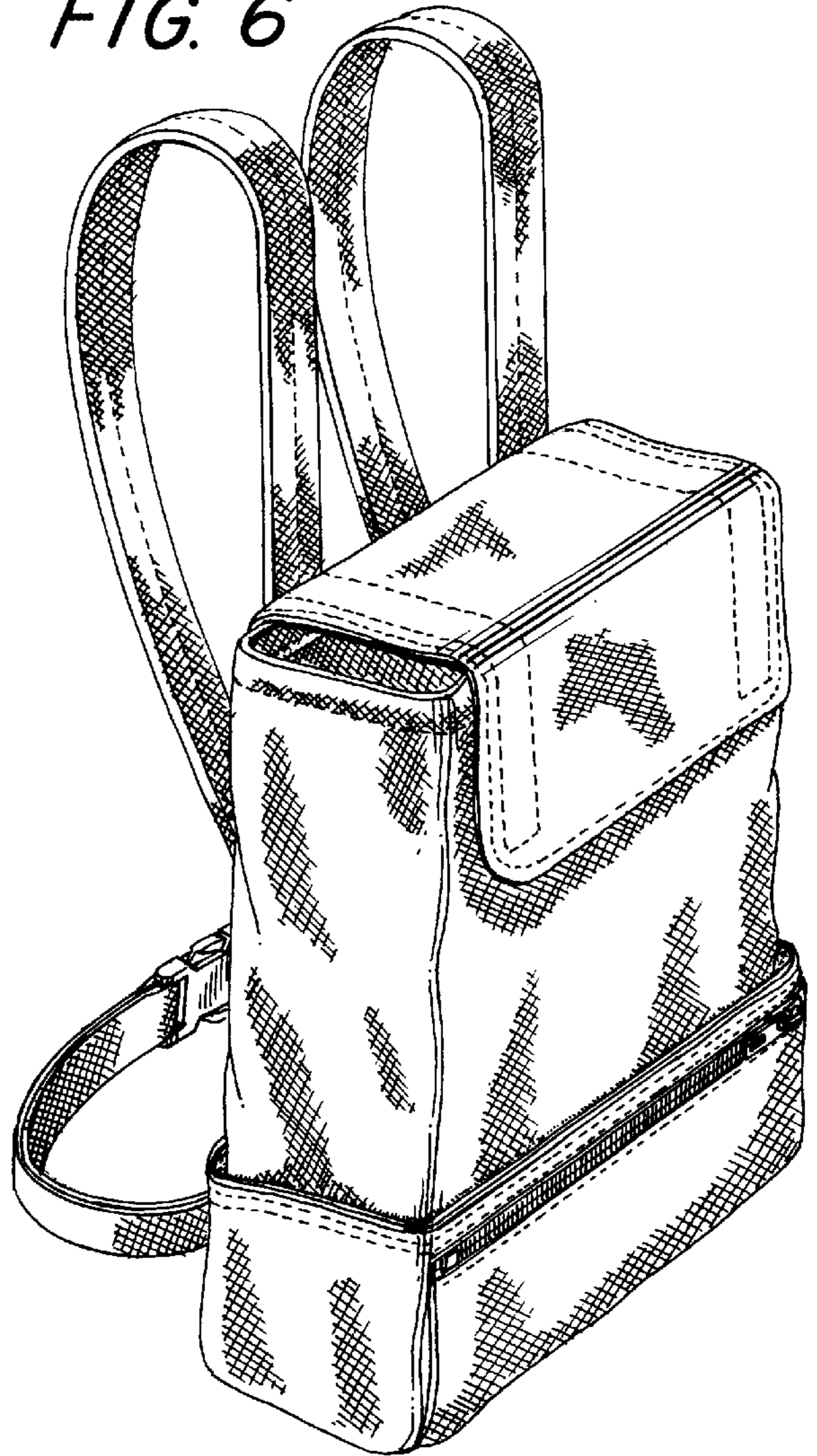

FIG. 7

