



US00D450437B1

(12) **United States Design Patent**  
**Simpson et al.**

(10) **Patent No.:** **US D450,437 S**

(45) **Date of Patent:** **\*\* Nov. 20, 2001**

(54) **FOOTWEAR MIDSOLE**

(75) Inventors: **Lantz Simpson**, Los Angeles; **Nathan Crary**, Los Alamitos, both of CA (US); **James K. Reichelt**, Granger Township, OH (US)

(73) Assignee: **LL International Shoe Company, Inc.**, Los Angeles, CA (US)

(\*\*) Term: **14 Years**

(21) Appl. No.: **29/144,333**

(22) Filed: **Jun. 27, 2001**

**Related U.S. Application Data**

(63) Continuation-in-part of application No. 29/135,944, filed on Jan. 22, 2001, now abandoned.

(51) **LOC (7) Cl.** ..... **02-04**

(52) **U.S. Cl.** ..... **D2/967; D2/946; D2/977**

(58) **Field of Search** ..... D2/896, 902, 946, D2/947, 951, 952, 953, 954, 955, 956, 957, 958, 964, 972, 977; 36/22 R, 25 R, 27-29, 30 R, 32 R, 37, 114, 3 R, 3 B, 7.8

(56) **References Cited**

**U.S. PATENT DOCUMENTS**

- D. 307,608 5/1990 Shure .
- D. 341,478 11/1993 Forland et al. .
- D. 342,601 \* 12/1993 Kilgore et al. .... D2/977
- D. 344,174 2/1994 Kilgore .

(List continued on next page.)

**OTHER PUBLICATIONS**

“Changing the Way the World Walks”, Z. Tech. Footwear, Europe; believed published circa 1999; published over the worldwide web at address: <http://www.geocities.com/Pipeline/Slope/8676/>.

“Z-Coil Shoes for Pain Relief”; author unknown: Web Site believed published circa 1998; sections include “Our Company”, “Shoe Anatomy”, “Styles”, “Products”, and “History”; published over the world wide web at <http://www.zcoil.com/>.

“Boing!” By Ron Lieber; Nov., 2000; published by Fast Company over the worldwide web at address: [http://www/fastcompany.com/online/40/nike.html](http://www.fastcompany.com/online/40/nike.html).

“Making Shoes that Bounce Back, Power UP,” Popular Science, Nov. 2000; published by Times Mirror Magazine, New York, NY, pp. 57 and 58.

(List continued on next page.)

*Primary Examiner*—Celia Murphy

(74) *Attorney, Agent, or Firm*—Greer, Burns & Crain, Ltd.

(57) **CLAIM**

The ornamental design for a footwear midsole, as shown and described.

**DESCRIPTION**

The present application is related to commonly owned co-pending utility patent application Ser. No. 09/766,786 filed Jan. 22, 2001.

FIG. 1 is a perspective view of a footwear midsole showing our new design, the broken lines showing a shoe upper and outsole being shown as the environment in which the design resides, but form no part of the claim;

FIG. 2 is a left side elevational view thereof;

FIG. 3 is a right side elevational view thereof;

FIG. 4 is a rear elevational view thereof;

FIG. 5 is a top plan view thereof.

FIG. 6 is a bottom plan view thereof, the unclaimed outsole being removed for clarity of illustration; and,

FIG. 7 is a top plan view thereof; the unclaimed shoe upper also being removed for clarity of illustration.

The invention is characterized by a midsole heel portion featuring four shock absorbers, between an upper heel cup and a bottom plate, and a heel stiffener on the medial side of the heel. The broken line illustration is not part of the design sought to be patented.

**1 Claim, 3 Drawing Sheets**

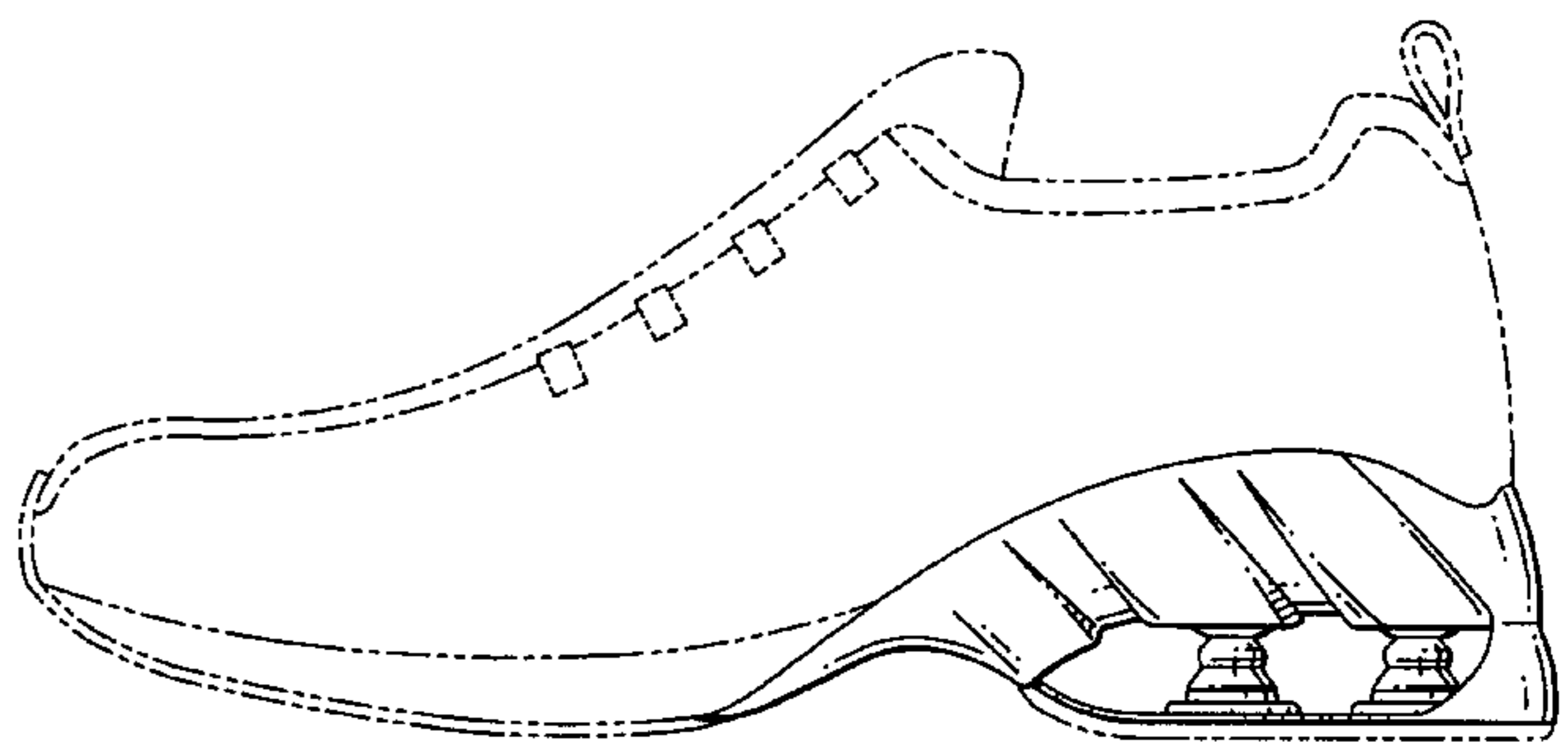
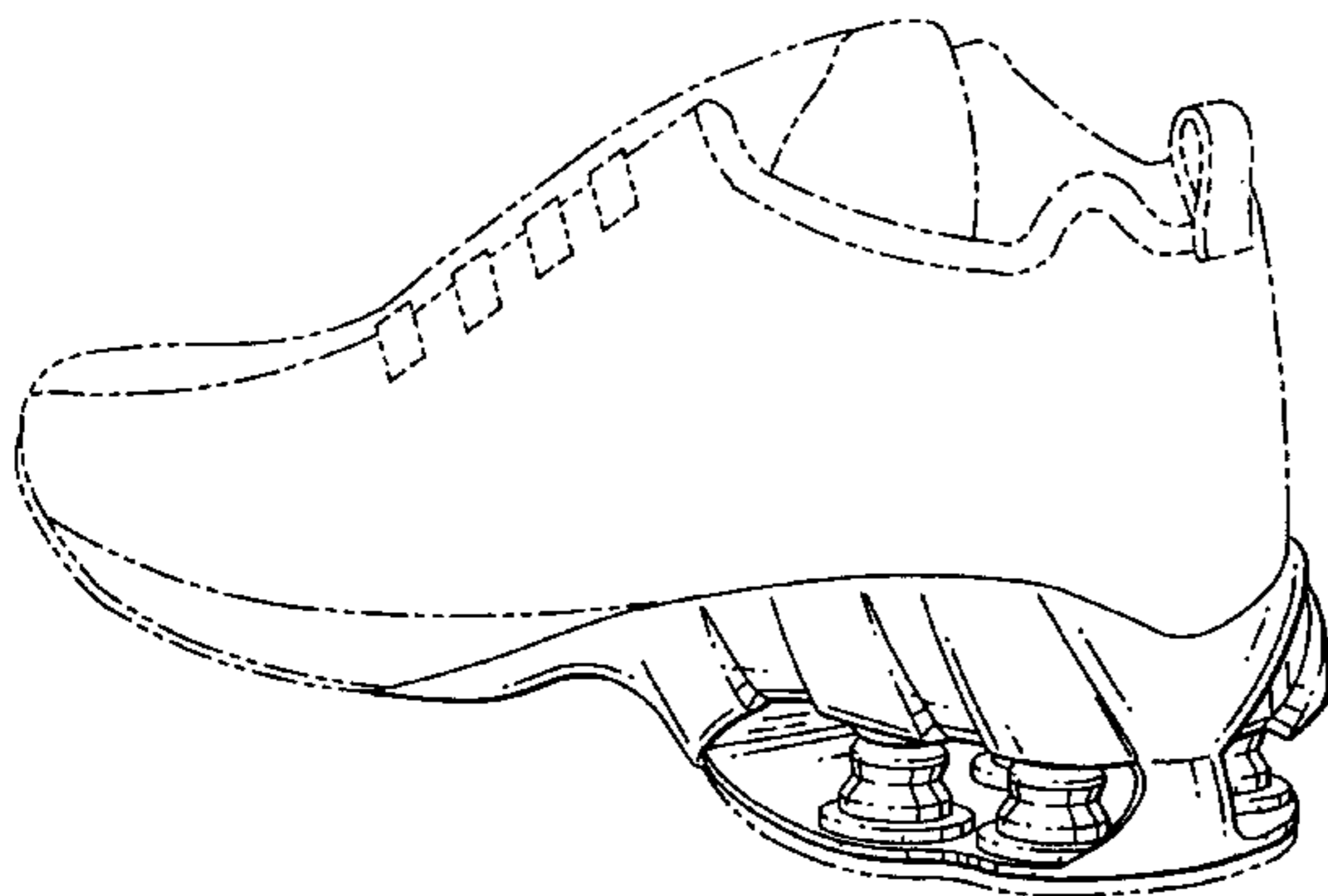

U.S. PATENT DOCUMENTS

D. 344,398	2/1994	Kilgore .	
D. 344,399	2/1994	Kilgore .	
D. 344,400	2/1994	Kilgore .	
D. 344,401	2/1994	Kilgore .	
D. 344,622	3/1994	Kilgore .	
D. 350,018	8/1994	Kilgore .	
D. 350,019	8/1994	Kilgore .	
D. 350,020	8/1994	Kilgore .	
D. 350,225	9/1994	Kilgore .	
D. 350,226	9/1994	Kilgore .	
D. 350,227	9/1994	Kilgore .	
D. 350,433	9/1994	Kilgore .	
D. 351,057	10/1994	Kilgore .	
D. 351,720	10/1994	Kilgore .	
D. 351,936	11/1994	Kilgore .	
D. 352,159	11/1994	Kilgore .	
D. 352,160	11/1994	Kilgore .	
D. 354,617	1/1995	Kilgore .	
D. 355,755	2/1995	Kilgore .	
D. 397,543	9/1998	Silvers .	
D. 401,038	* 11/1998	Gray .....	D2/947
D. 411,242	* 6/1999	Link .....	D2/947
413,693	10/1889	Walker .	
D. 429,877	8/2000	Lozanno et al. .	
D. 431,898	10/2000	Clegg et al. .	
D. 432,293	10/2000	Clegg et al. .	
D. 432,764	* 10/2000	Clegg et al. ....	D2/955
D. 433,216	11/2000	Avar .	
D. 434,548	12/2000	Gallegos .	
507,490	10/1893	Gambino .	
1,670,747	* 5/1928	Sestito .....	36/28
2,234,066	3/1941	Winkel et al. .	
2,399,543	4/1946	Dack .	
2,414,445	1/1947	Cahill .	
2,669,038	2/1954	DeWerth .	
3,822,490	7/1974	Murawski .	
3,886,674	6/1975	Pavia .	
3,996,677	12/1976	Reina .	
4,296,557	10/1981	Pajevic .	
4,314,413	* 2/1982	Dassler .....	36/129
4,322,892	4/1982	Inohara .	
4,322,893	* 4/1982	Halvorsen .....	36/28
4,342,158	* 8/1982	McMahon et al. ....	36/35 R
4,354,318	* 10/1982	Frederick et al. ....	36/30 R
4,360,978	11/1982	Simpkins .	
4,364,188	* 12/1982	Turner et al. ....	36/31
4,391,048	* 7/1983	Lutz .....	36/28
4,416,072	* 11/1983	Sarkissian .....	36/100
4,457,084	7/1984	Horibata et al. .	
4,492,046	1/1985	Kosova .	
4,506,460	* 3/1985	Rudy .....	36/28
4,534,124	8/1985	Schnell .	
4,535,553	* 8/1985	Derderian et al. ....	36/28
4,566,206	1/1986	Weber .	
4,592,153	6/1986	Jacinto .	
4,660,299	* 4/1987	Omilusik .....	36/7.8
4,817,304	4/1989	Parker et al. .	

4,887,367	* 12/1989	Mackness et al. ....	36/28
4,918,838	* 4/1990	Chang .....	36/28
5,060,401	* 10/1991	Whatley .....	36/25 R
5,152,081	* 10/1992	Hallenbeck et al. ....	36/28
5,212,878	* 5/1993	Burke et al. ....	36/27
5,224,278	* 7/1993	Jeon .....	36/29
5,235,761	* 8/1993	Chang .....	36/3 R
5,247,742	* 9/1993	Kilgore et al. ....	36/114
5,279,051	1/1994	Whatley .	
5,282,325	2/1994	Beyl .	
5,297,349	* 3/1994	Kilgore .....	36/114
5,343,636	9/1994	Sabol .	
5,343,639	9/1994	Kilgore et al. .	
5,353,523	10/1994	Kilgore et al. .	
5,435,079	7/1995	Gallegos .	
5,461,800	10/1995	Luthi et al. .	
5,572,804	11/1996	Skaja et al. .	
5,621,984	4/1997	Hsieh .	
5,701,685	12/1997	Pezza .	
5,701,686	12/1997	Herr et al. .	
5,752,329	5/1998	Horibata .	
5,791,637	8/1998	Reichelt et al. .	
5,822,886	* 10/1998	Luthi et al. ....	36/28
5,853,844	12/1998	Wen .	
6,006,449	12/1999	Orlowski et al. .	
6,029,962	2/2000	Shorten et al. .	

OTHER PUBLICATIONS

“Motor City Musing Nike Borrows from Formula One to Race on Sunday, Run on Monday,” by John Clor, believed published circa Nov. 2000; published over the worldwide web at address: <http://www.edmunds.com/edweb/editorial/McMusings/Nike>.

Nike to Shox the World, Press Release Authored by Nike Corp., Beaverton, OR., Nov. 15, 2000, Yahoo! Finance, published on the worldwide web by Yahoo! at address: [http://biz.yahoo.com/prnews/001115/or\\_nike\\_sh.html](http://biz.yahoo.com/prnews/001115/or_nike_sh.html).

“Working Progress (bulletin board comment)”, authored by David Nix, believed published circa Nov. 2000, published by Fast Company on the world wide web at: [http://www.fastcompany.com/soundoff/reader\\_comment.html?cid=1734](http://www.fastcompany.com/soundoff/reader_comment.html?cid=1734).

Z. Tech Footwear , Europe, Changing the Way the World Walks, available over the worldwide web at address: <http://www.geocities.com/Pipeline/Slope/8676/>.

New Shoes . . . Hot Shoes . . . Cool Shoes . . . Coil Shoes, Z-Coil Footwear, catalog list, available over the worldwide web at address: <http://my.ecplaza.net/coilshoes/>.

Z-Coil Shoes for Pain Relief, Our Company, available over the web at address: <http://www.zcoil.com/company/index.htm>.

Borges Invention Design Disclosure believed created circa Mar. 1999; Documenting Invention created circa , 1998.

\* cited by examiner



FIG.1

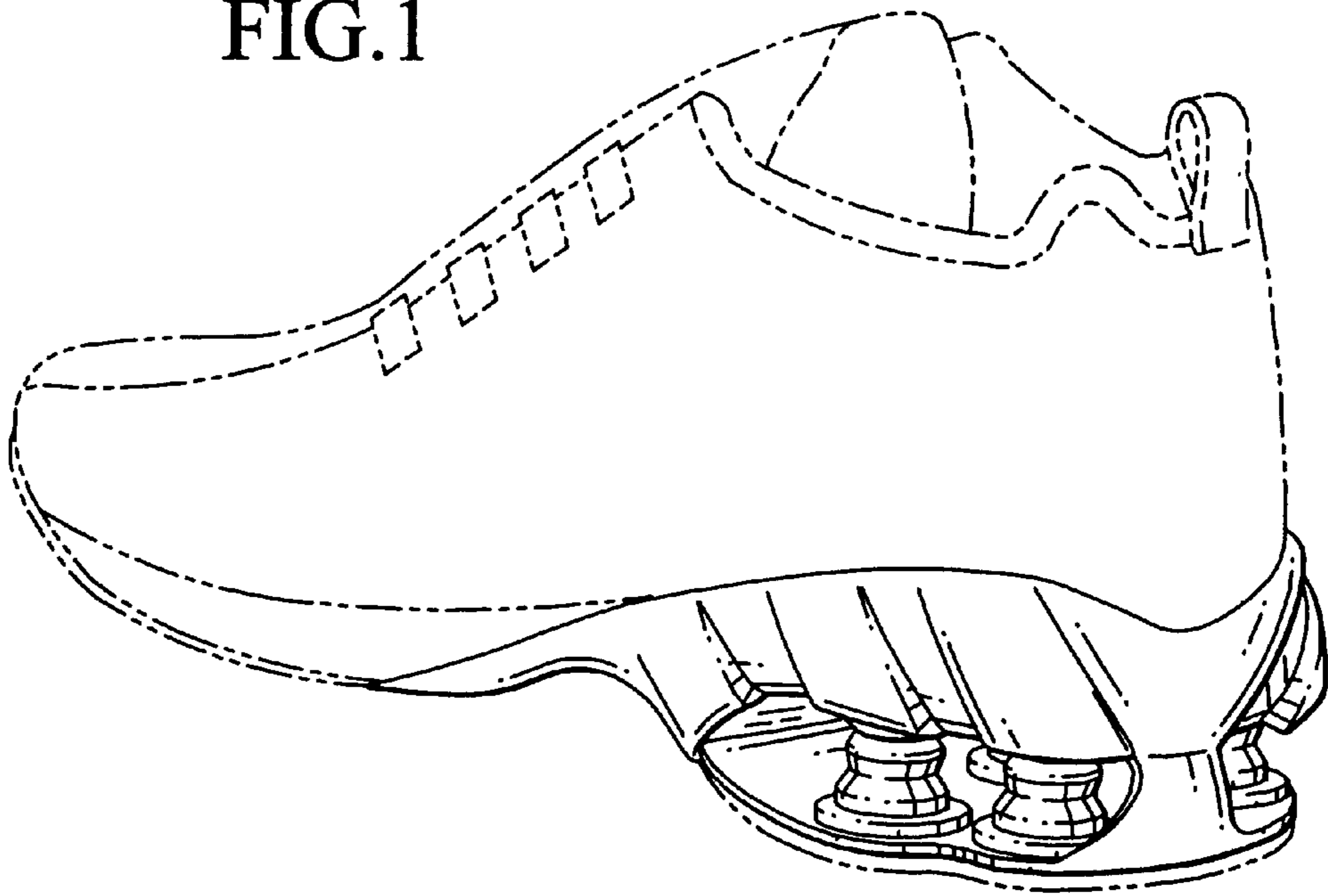
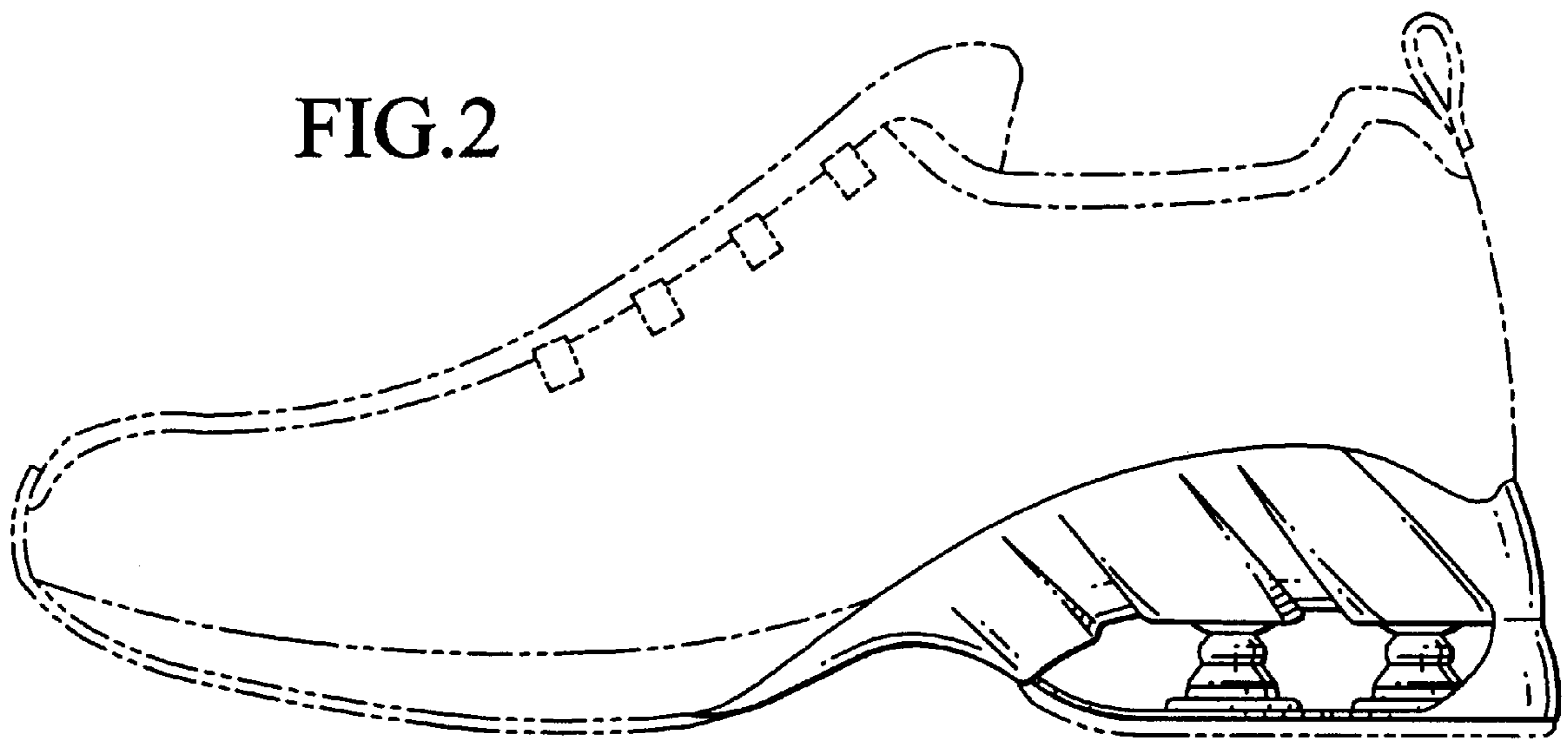

FIG.2



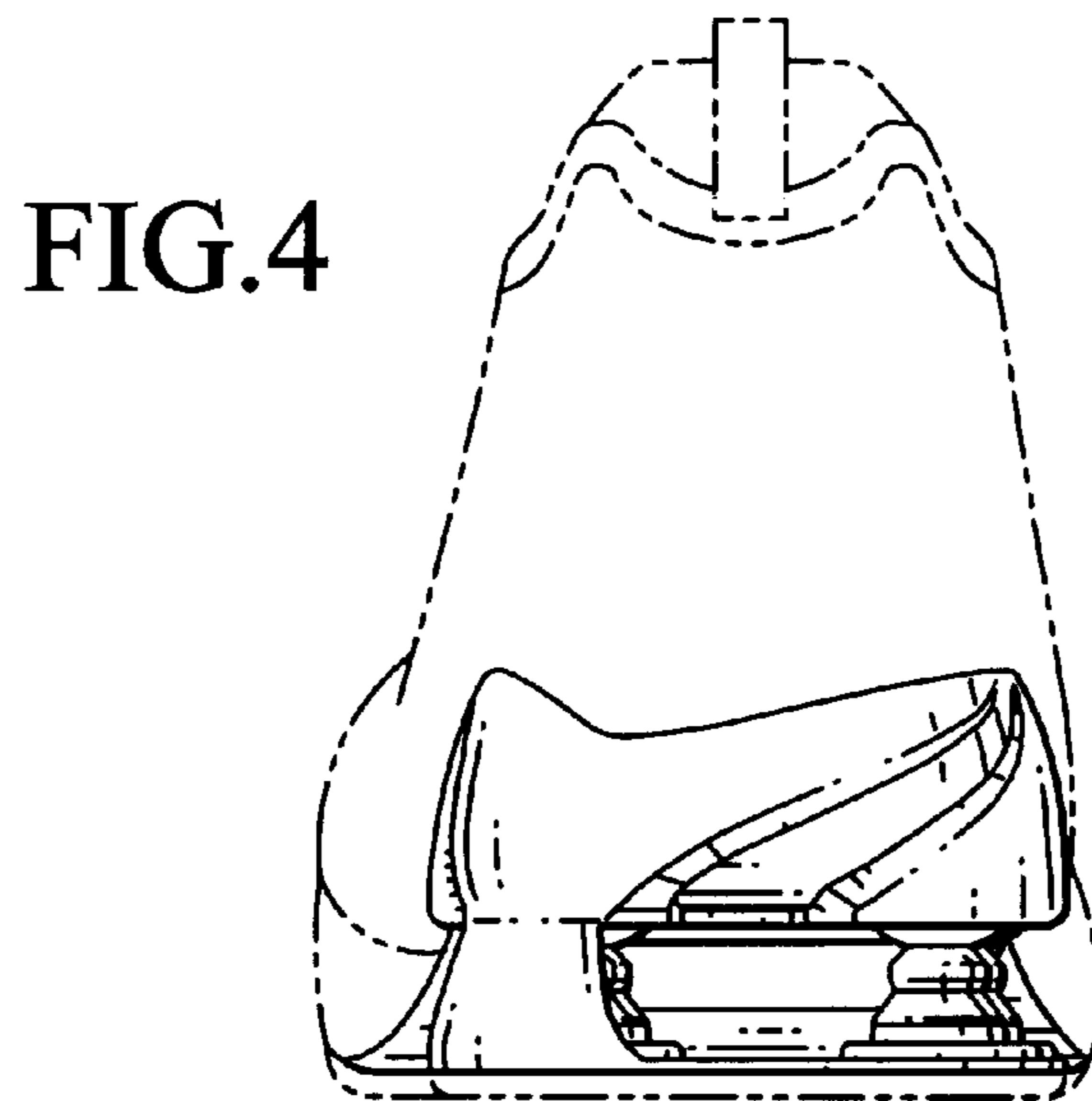
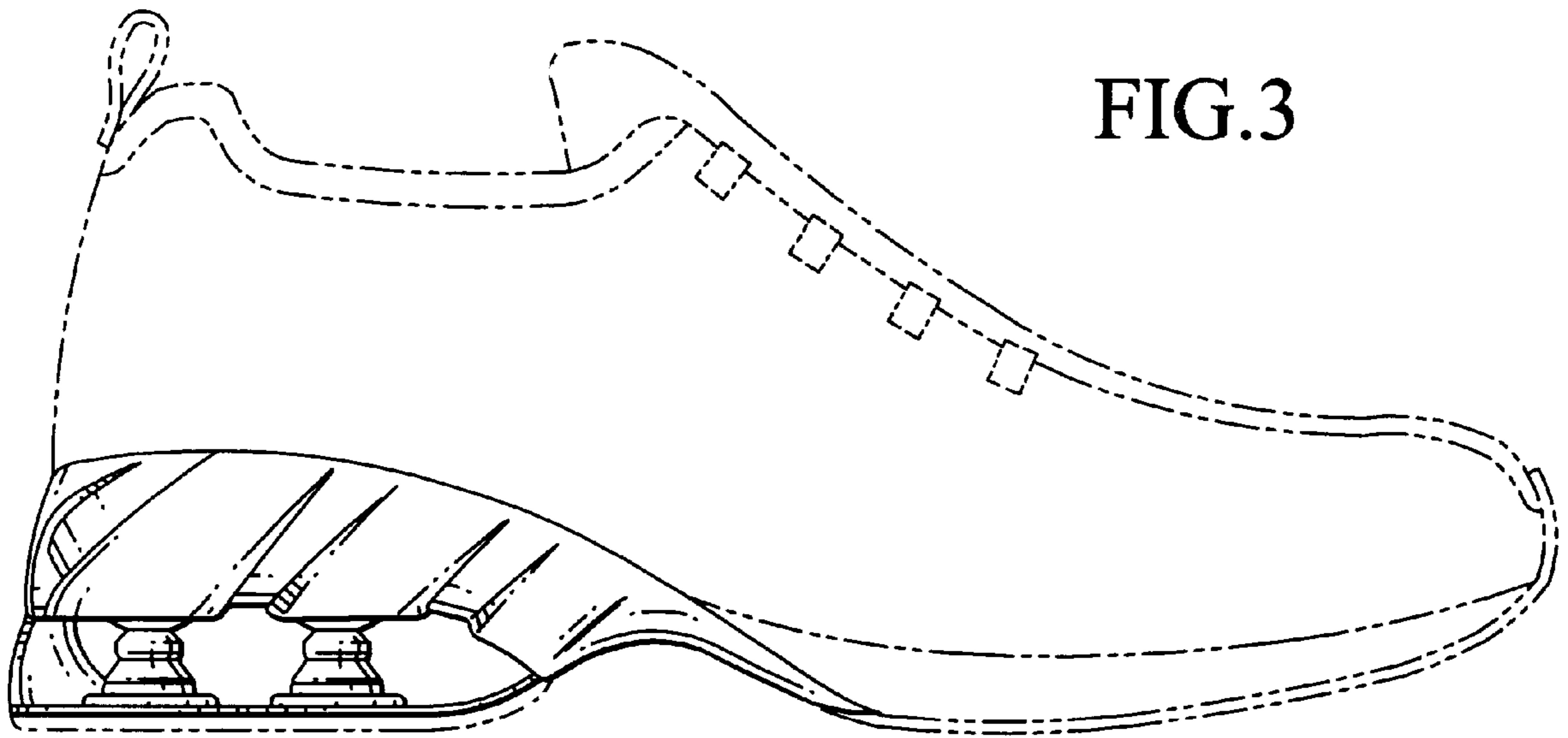

FIG.5

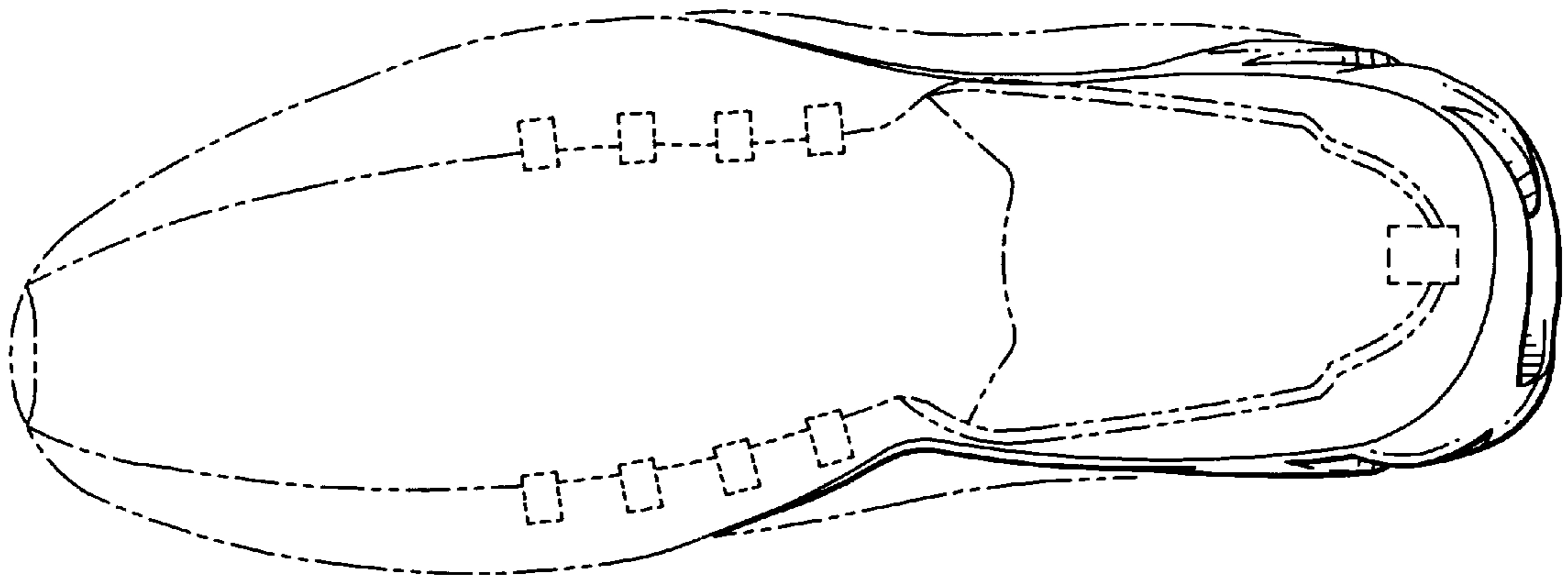

FIG.6

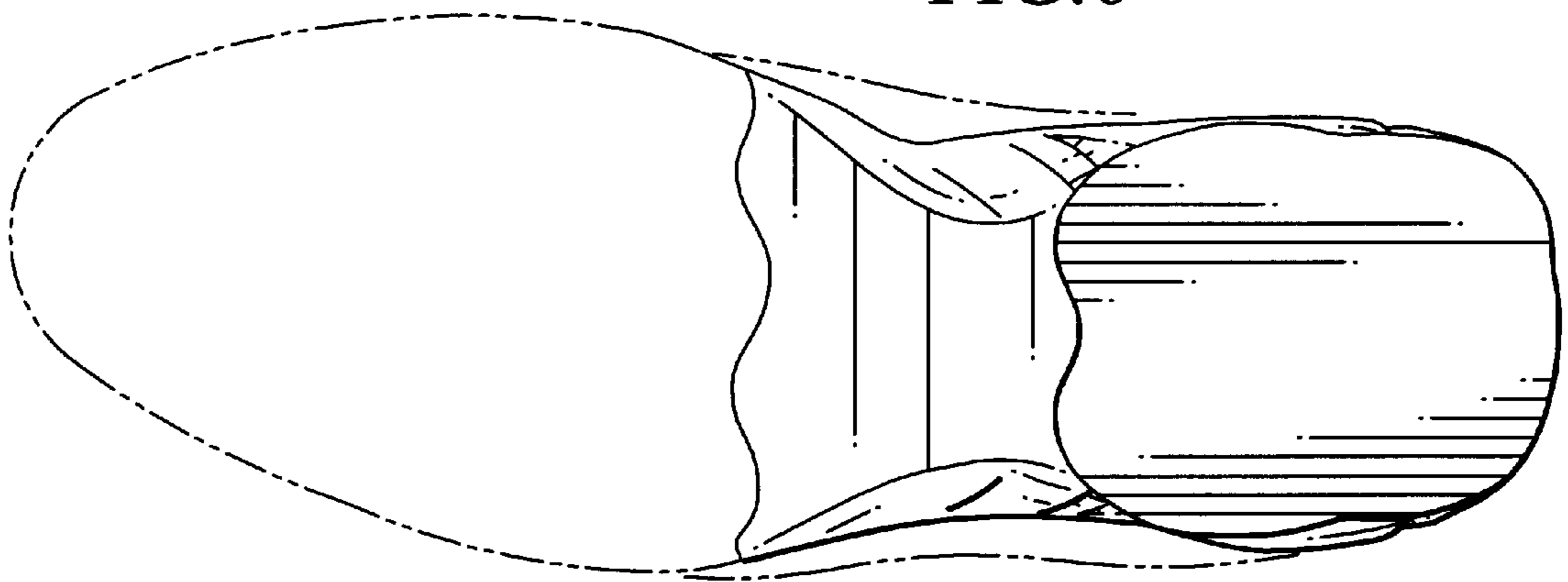
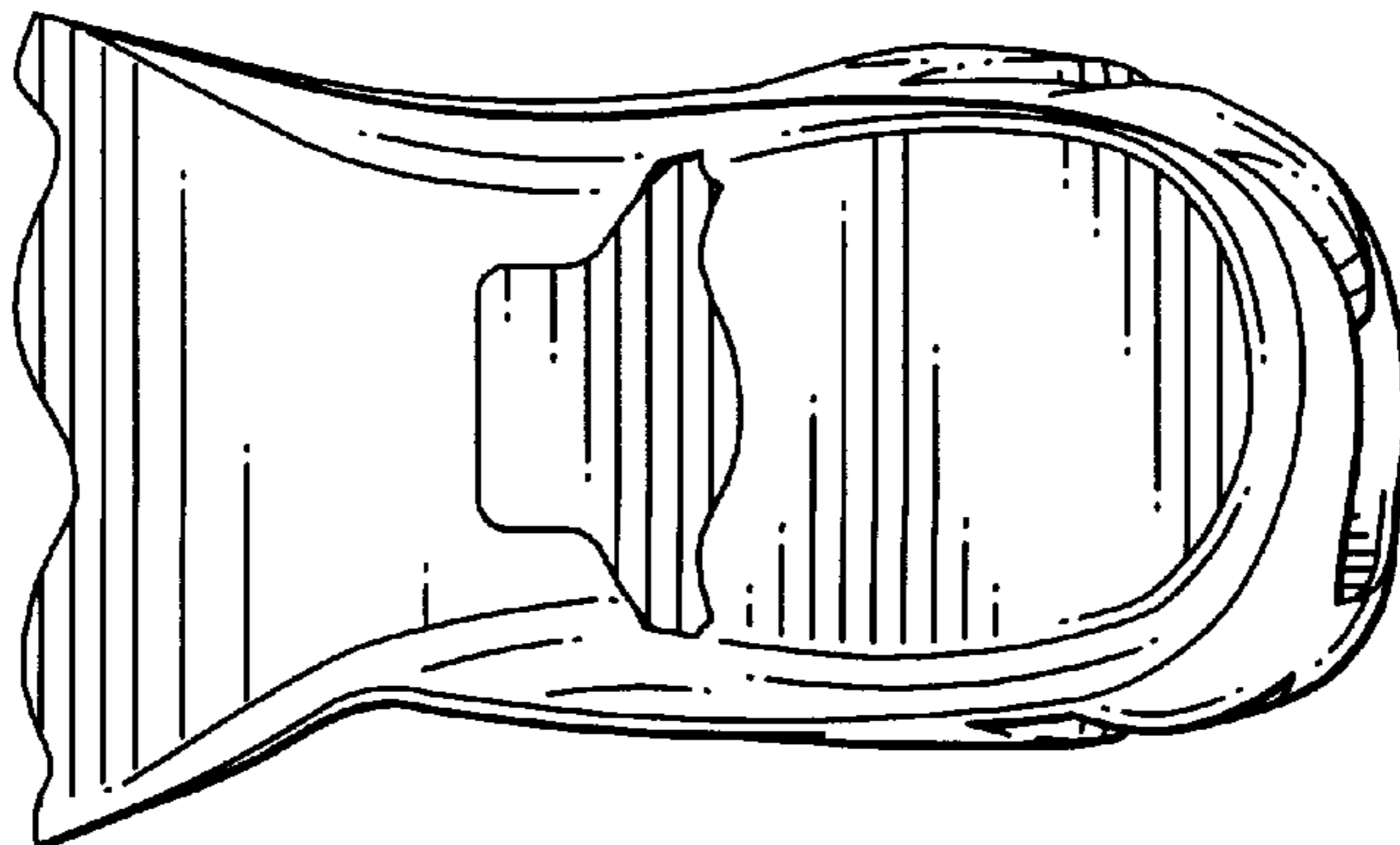

FIG.7



UNITED STATES PATENT AND TRADEMARK OFFICE  
**CERTIFICATE OF CORRECTION**

PATENT NO. : Des. 450,437 S  
DATED : November 30, 2001  
INVENTOR(S) : Simpson et al.

Page 1 of 1

It is certified that error appears in the above-identified patent and that said Letters Patent is hereby corrected as shown below:

Title page,

**DESCRIPTION,**

Line 4, delete "footwear midsole" and insert -- FOOTWEAR MIDSOLE --

Item [56], OTHER PUBLICATIONS,

Delete "Nike to Shox the World," and insert -- "Nike to Shox the World," --

Delete "reader comment" and insert -- reader comment --

Delete "hhttp" and insert -- http --

Signed and Sealed this

First Day of October, 2002

*Attest:*

A handwritten signature in black ink, appearing to read "James E. Rogan", written over a horizontal line.

*Attesting Officer*

JAMES E. ROGAN  
*Director of the United States Patent and Trademark Office*