



US00D450309B1

(12) **United States Design Patent**
Ishii et al.

(10) **Patent No.:** **US D450,309 S**

(45) **Date of Patent:** **** Nov. 13, 2001**

(54) **IC RECORDER**

(75) Inventors: **Daisuke Ishii; Tomonari Murakami,**
both of Tokyo (JP)

(73) Assignee: **Sony Corporation,** Tokyo (JP)

(**) Term: **14 Years**

(21) Appl. No.: **29/136,323**

(22) Filed: **Jan. 30, 2001**

(51) **LOC (7) Cl.** **14-01**

(52) **U.S. Cl.** **D14/167; D14/165**

(58) **Field of Search** **D14/154, 160-168,**
D14/188, 192, 194-196; 446/302, 397,
408; 455/344, 347, 350, 351

(56) **References Cited**

U.S. PATENT DOCUMENTS

D. 334,933	*	4/1993	Takahashi	D14/165
D. 372,476	*	8/1996	Shiger	D14/165
D. 385,274	*	10/1997	Shimobayash	D14/165 X
D. 427,176		6/2000	Obata	.	
D. 427,177	*	6/2000	Yamazak	D14/192
D. 430,134		8/2000	Obata et al.	.	
D. 438,857		3/2001	Ishii	.	
3,871,112	*	3/1975	Licitis	446/408 X

OTHER PUBLICATIONS

Catalog, "96", p. 125., Sony Corporation, (Nov. 2000).

* cited by examiner

Primary Examiner—Nanda Bondade

(74) *Attorney, Agent, or Firm*—Rader, Fishman & Grauer, PLLC

(57) **CLAIM**

The ornamental design for an IC recorder, as shown and described.

DESCRIPTION

FIG. 1 is a perspective view of an IC recorder showing our design;

FIG. 2 is a top plan view thereof;

FIG. 3 is a bottom plan view thereof;

FIG. 4 is a left side elevational view thereof;

FIG. 5 is a right side elevational view thereof;

FIG. 6 is a front elevational view thereof; and

FIG. 7 is a rear elevational view thereof;

FIG. 8 is a perspective view of another embodiment of an IC recorder showing our design;

FIG. 9 is a top plan view thereof;

FIG. 10 is a bottom plan view thereof;

FIG. 11 is a left side elevational view thereof;

FIG. 12 is a right side elevational view thereof;

FIG. 13 is a front elevational view thereof; and,

FIG. 14 is a rear elevational view thereof.

1 Claim, 8 Drawing Sheets

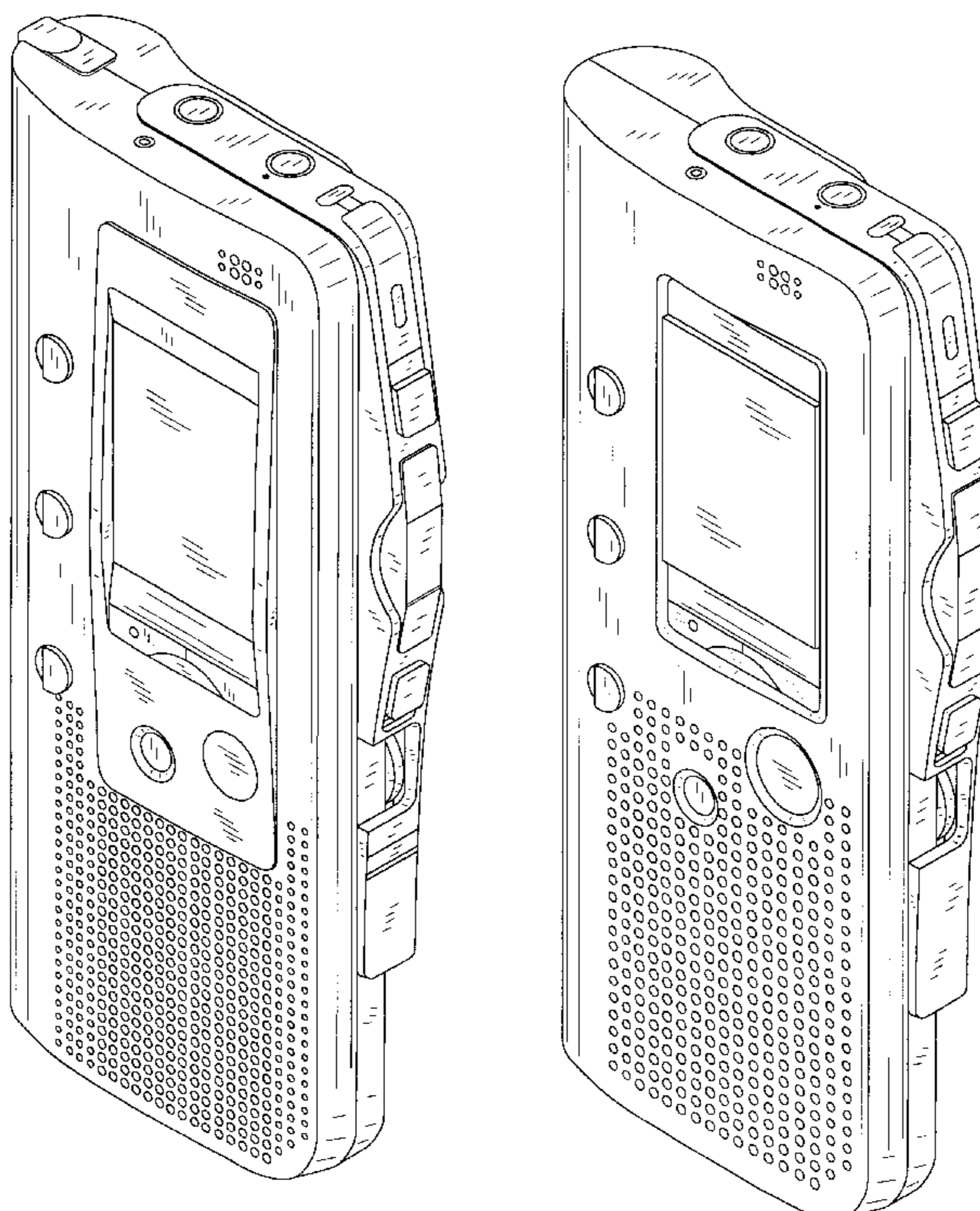

FIG. 1

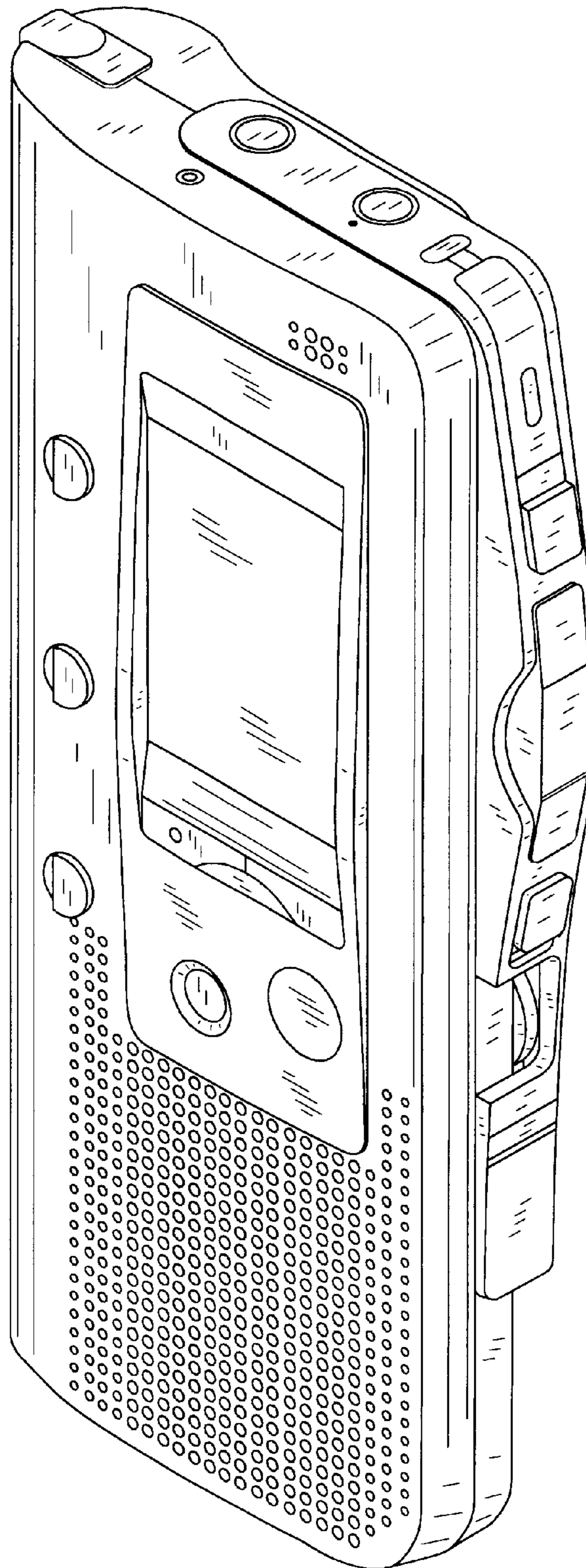

FIG. 2

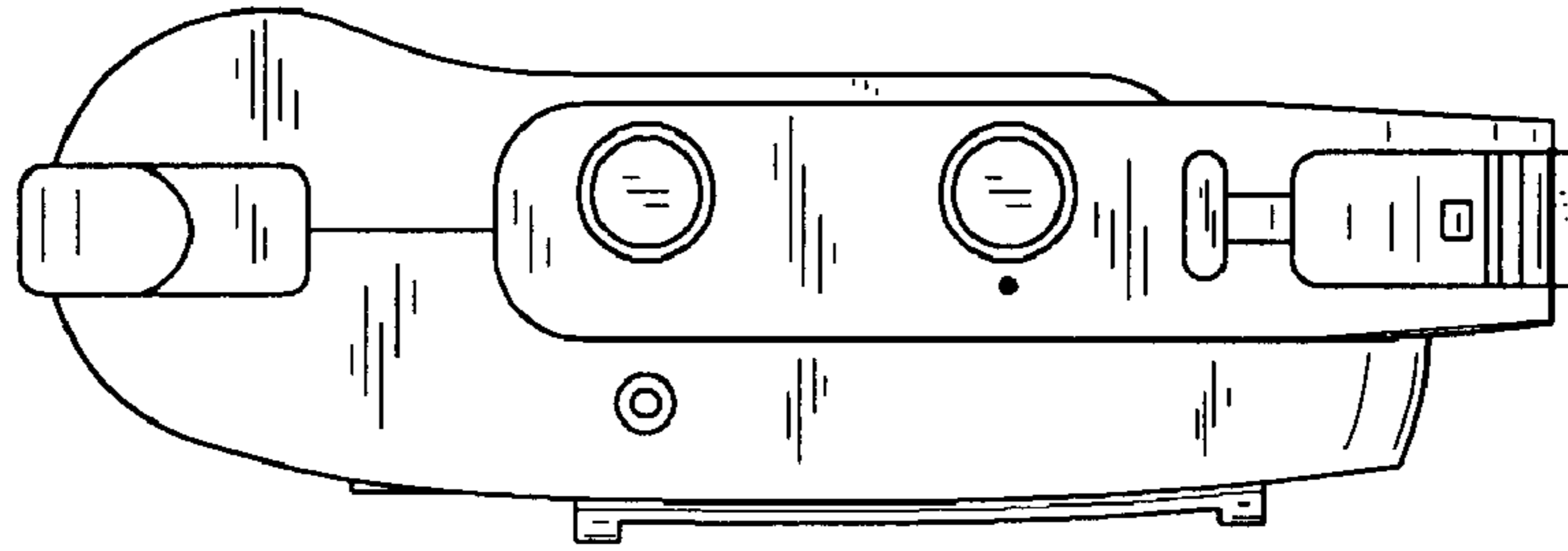

FIG. 3

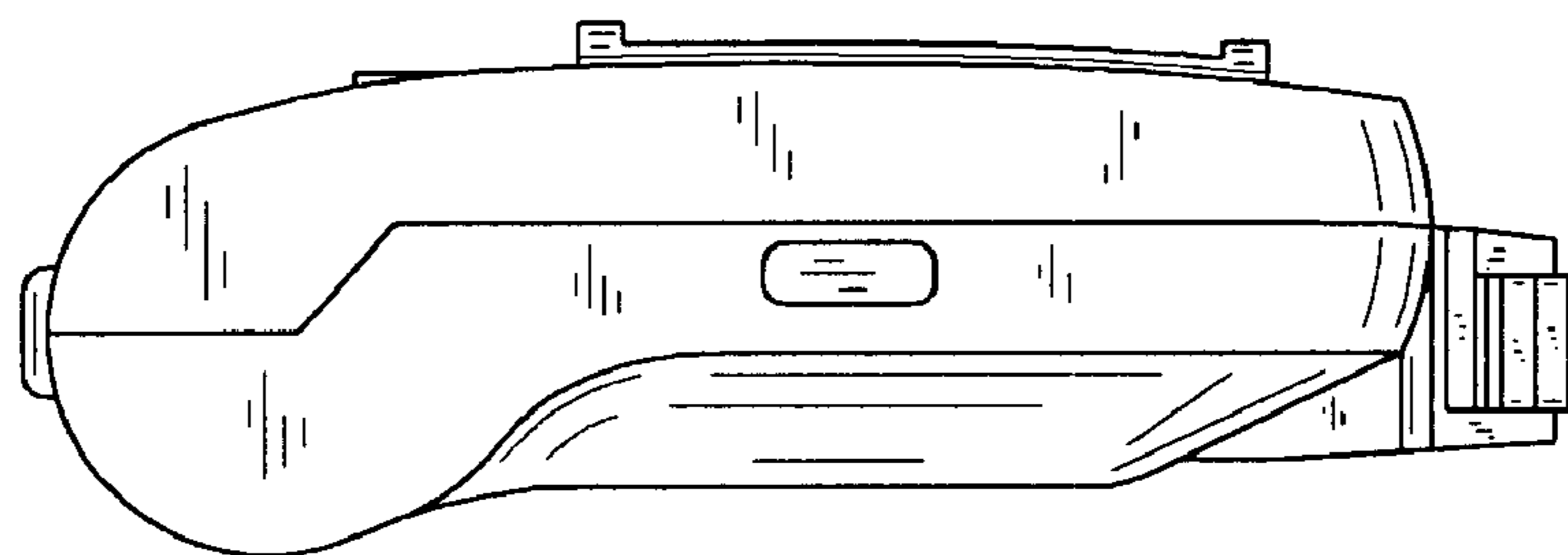

FIG. 4

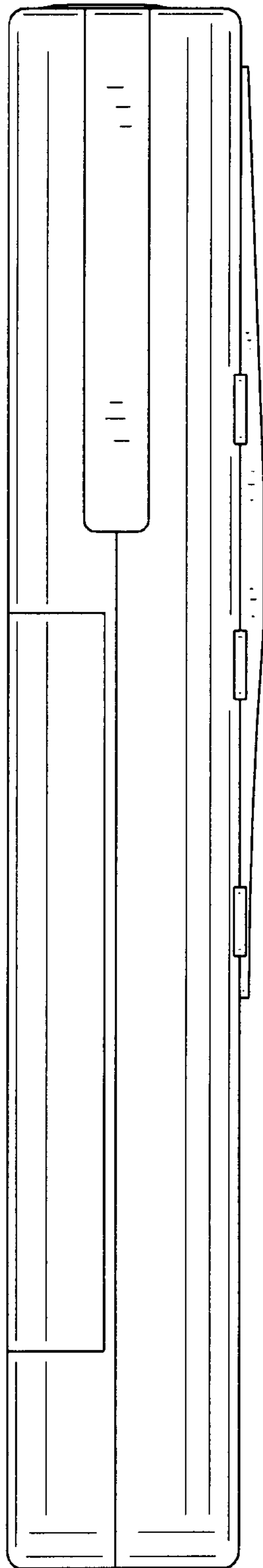

FIG. 5

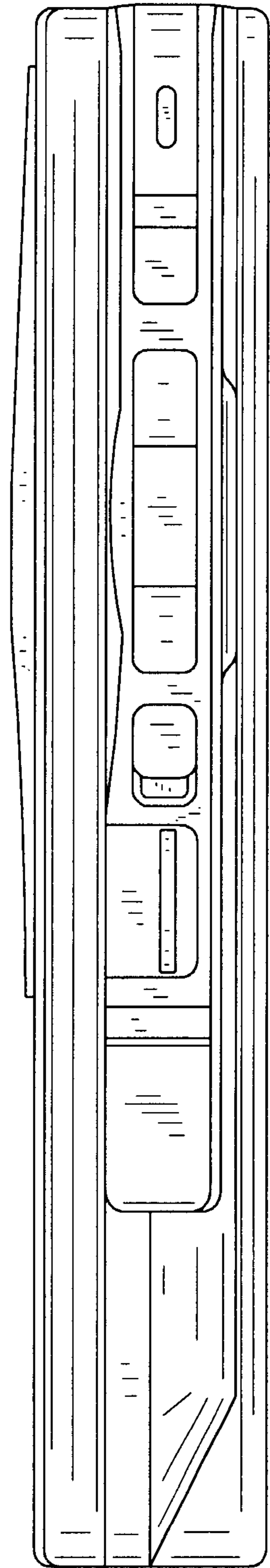

FIG. 6

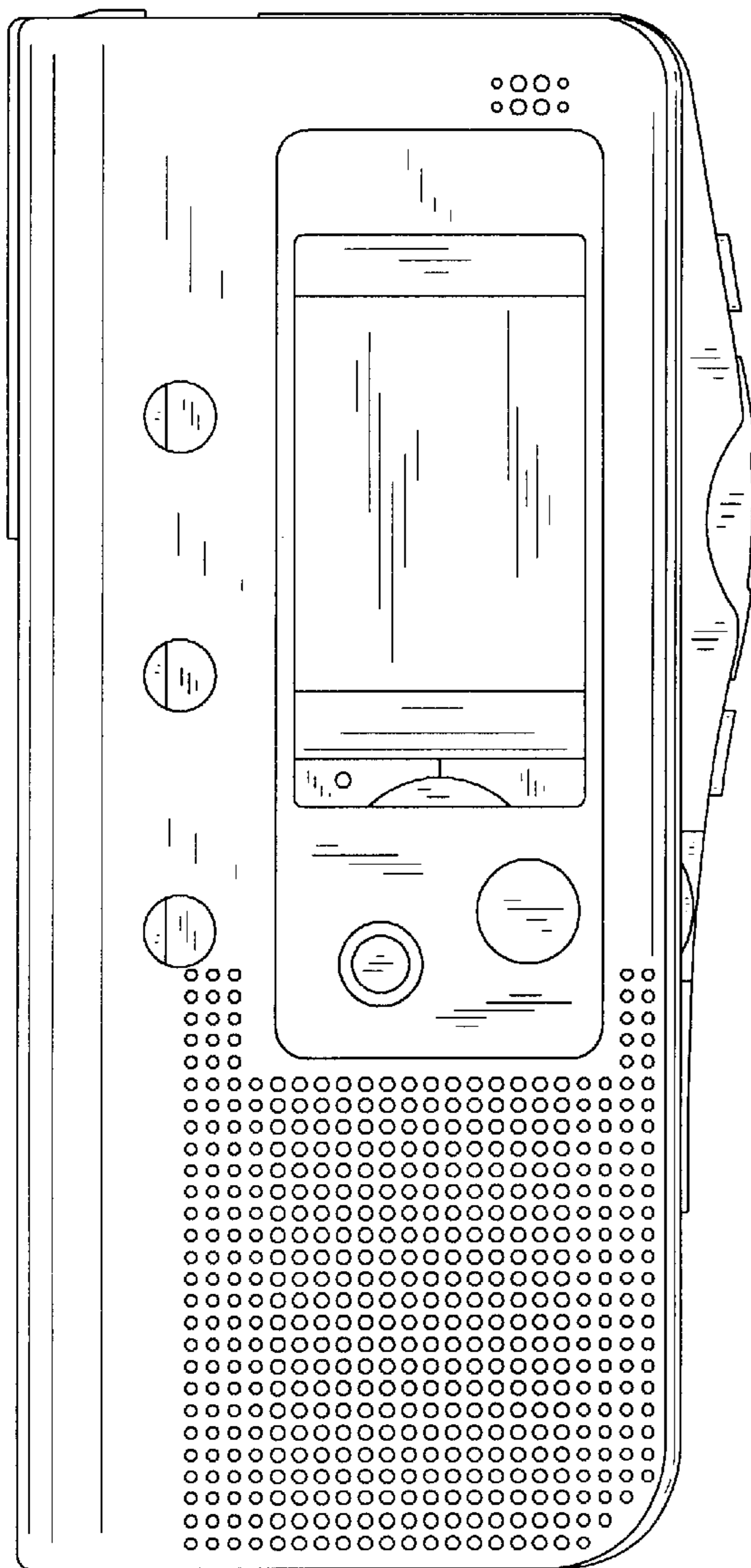

FIG. 7

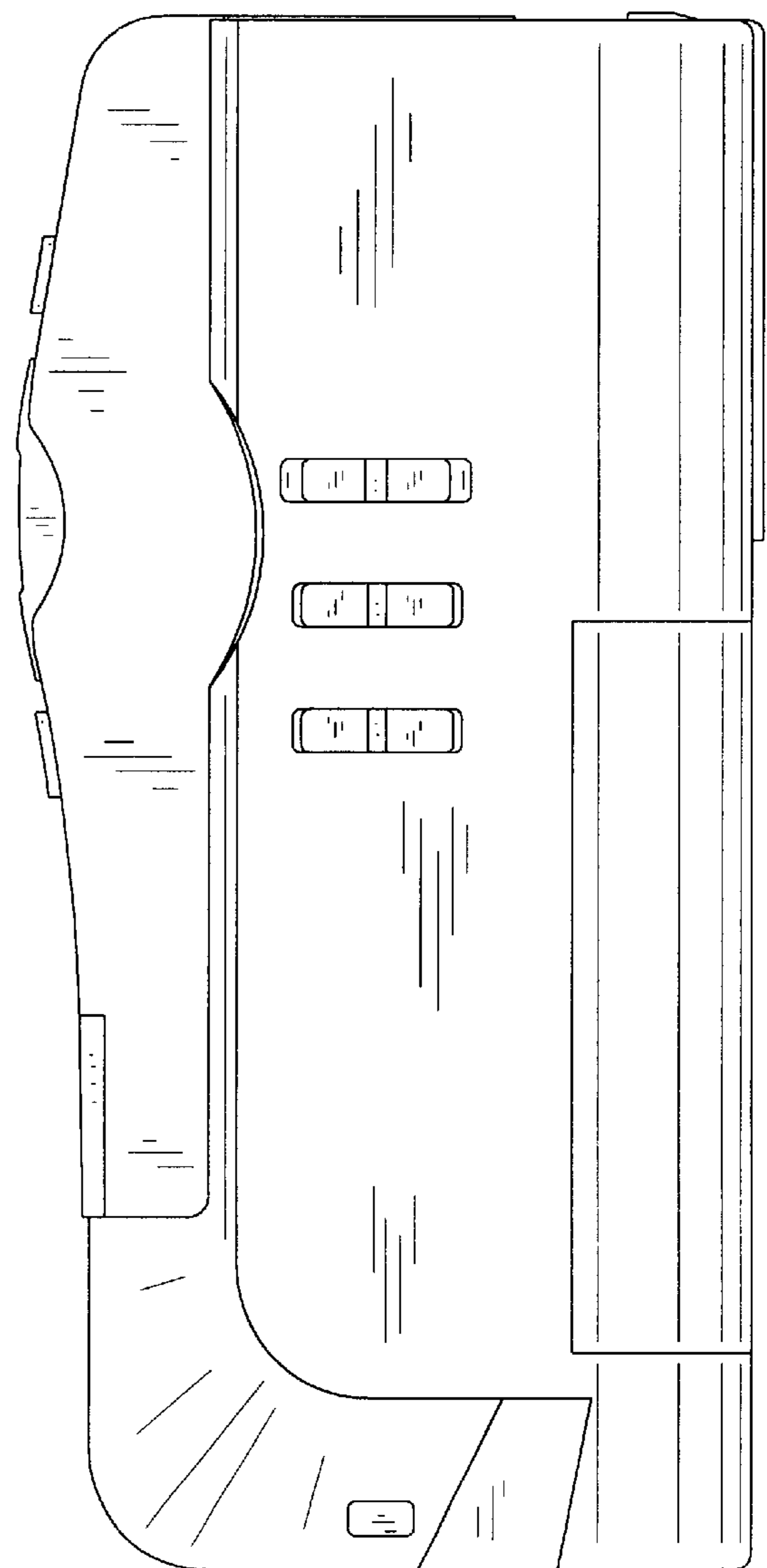

FIG. 8

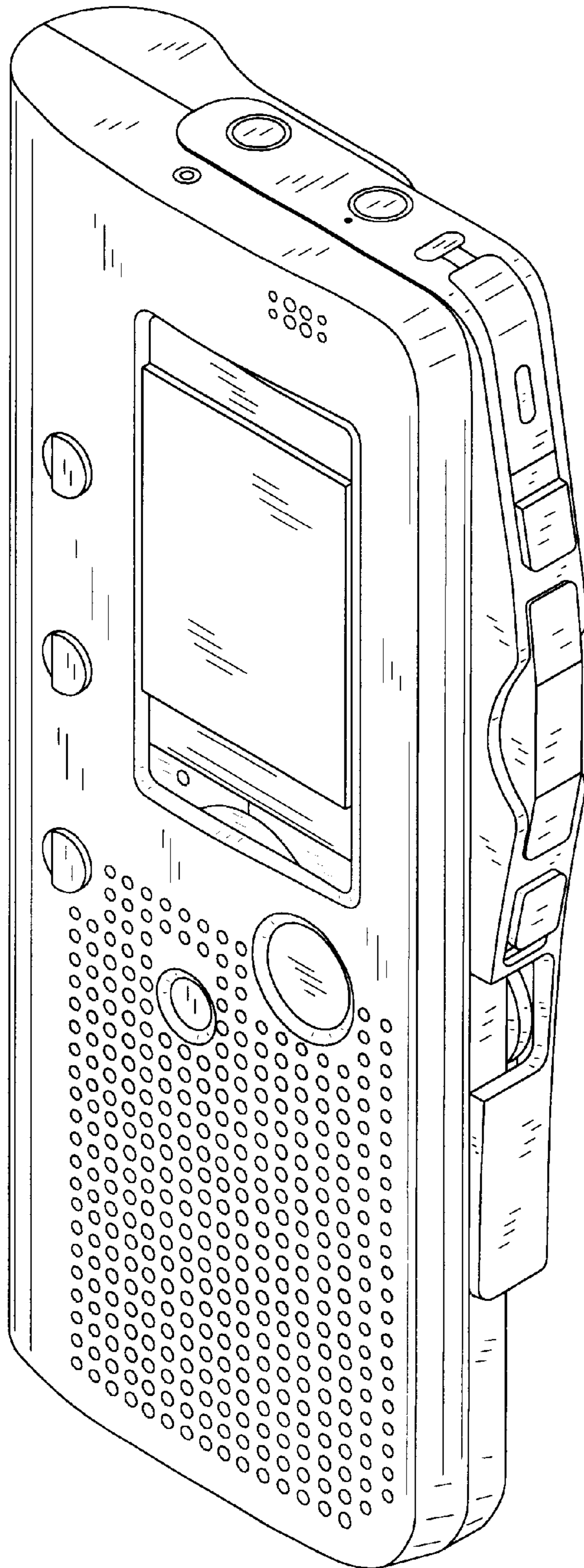

FIG. 9

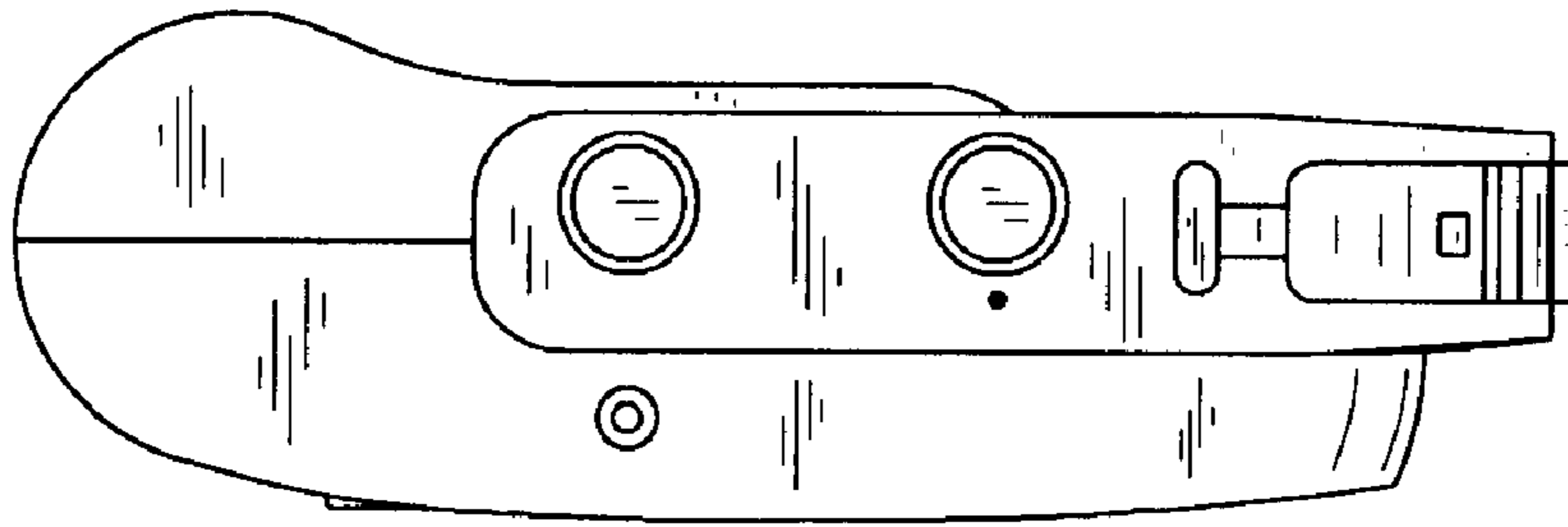

FIG. 10

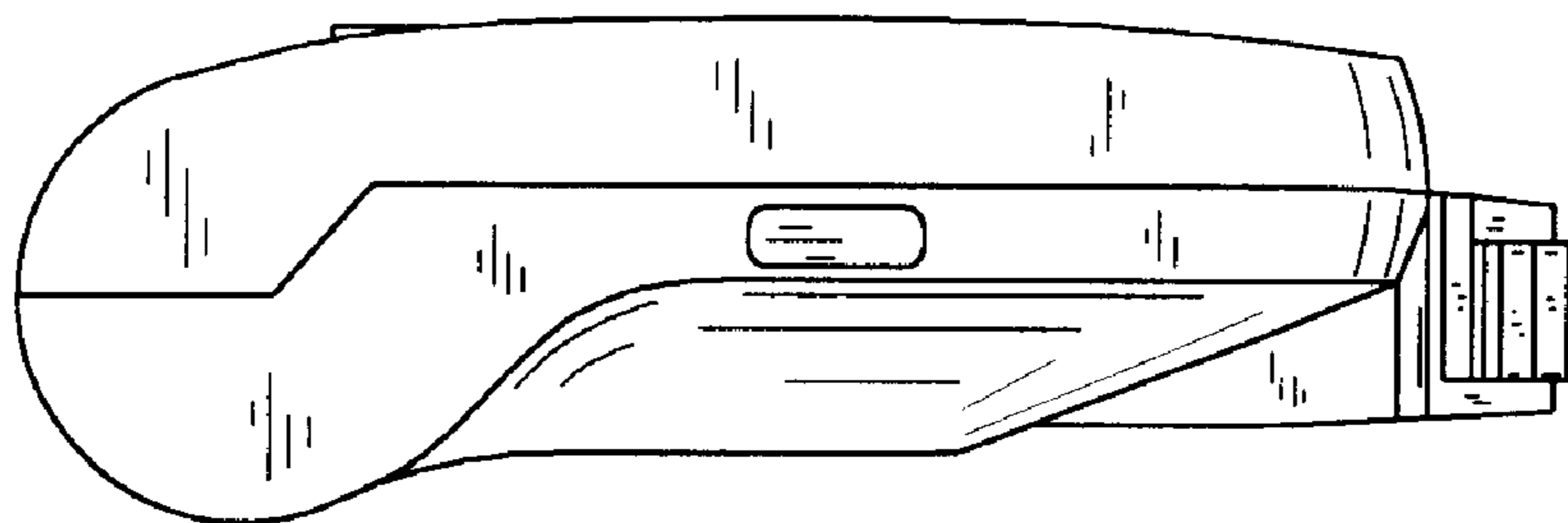

FIG. 11

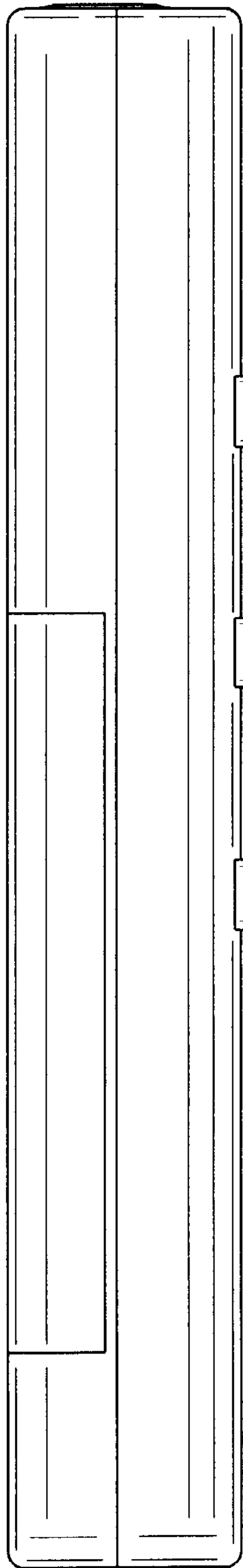

FIG. 12

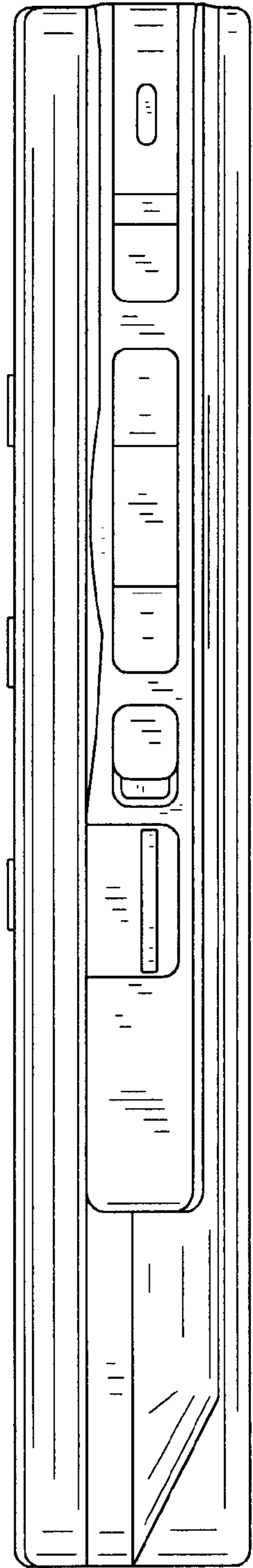

FIG. 13

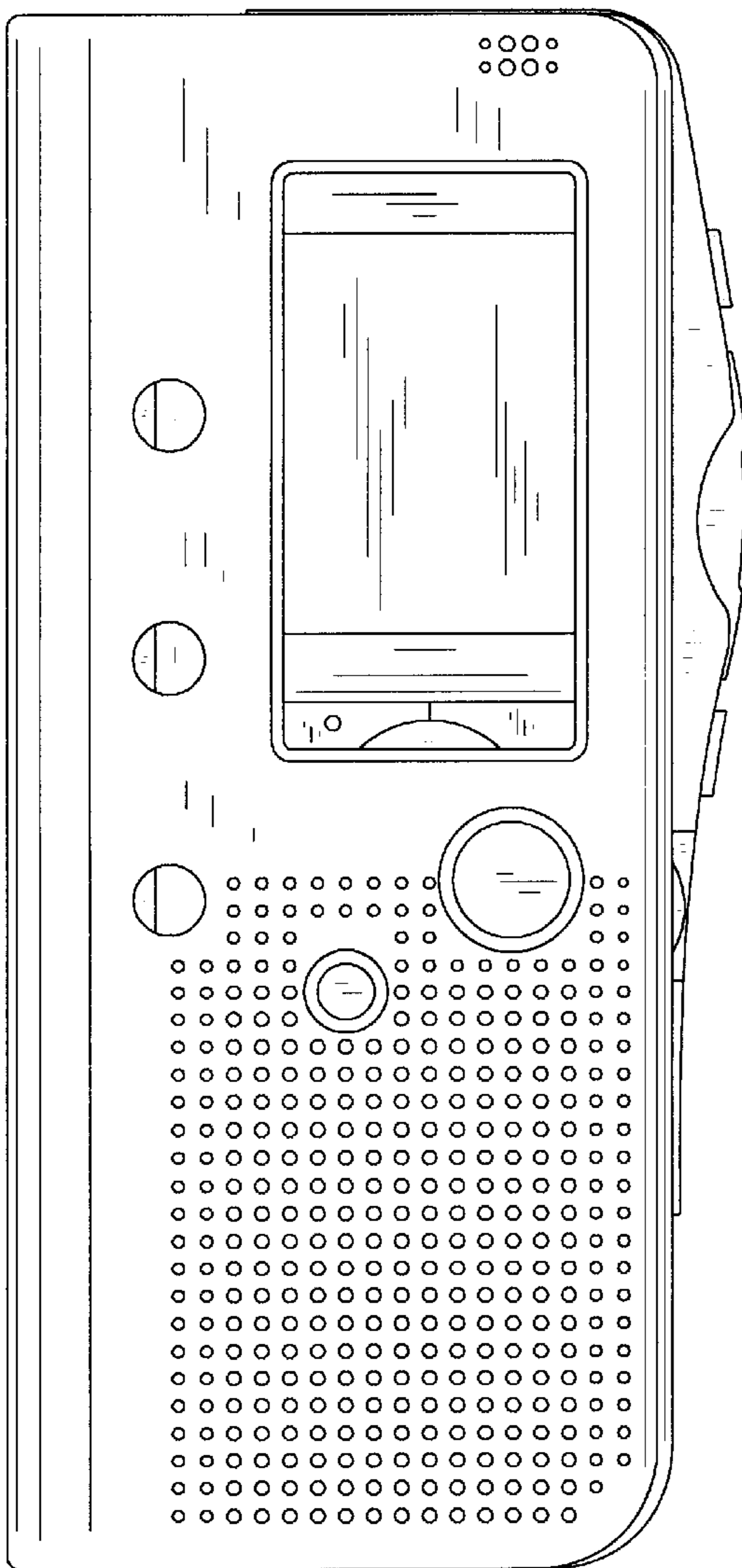

FIG. 14

