



US00D450239B1

(12) **United States Design Patent**
Otto

(10) **Patent No.:** **US D450,239 S**

(45) **Date of Patent:** **** Nov. 13, 2001**

(54) BATTERY PACKAGE	2035854	3/1994 (DE)	9/5.05
	521914-		
(75) Inventor: Andrew J. Otto , San Francisco, CA (US)	521921	11/1998 (FR)	9/5
	2004983	12/1990 (GB)	9/3.06
	2076091	1/1999 (GB)	9/5.05
	973235	1/1996 (JP)	.
(73) Assignee: Eveready Battery Company, Inc. , St. Louis, MO (US)	DM/048 155	5/1999 (WO)	.

(**) Term: **14 Years**

(21) Appl. No.: **29/117,088**

(22) Filed: **Jan. 14, 2000**

(51) **LOC (7) Cl.** **09-03**

(52) **U.S. Cl.** **D9/415**

(58) **Field of Search** D9/415, 418, 337,
D9/414; 206/461-471, 806, 703-705, 495,
769-781

(56) **References Cited**

U.S. PATENT DOCUMENTS

D. 239,436	*	4/1976	Williams	D9/415
D. 340,861		11/1993	Abelson	D9/415
D. 354,910		1/1995	Weatherford et al.	D9/415
D. 371,512	*	7/1996	Morita	D9/415
D. 385,488	*	10/1997	Smith et al.	D9/415
D. 422,210	*	4/2000	Sturkie et al.	D9/415
D. 429,634	*	8/2000	Pirro	D9/415
D. 430,016	*	8/2000	Pirro et al.	D9/415
3,288,280	*	11/1966	Bostrom	206/461
3,757,937	*	9/1973	Weinstein	206/461
4,549,658	*	10/1985	Sfikas	206/461
4,723,656	*	2/1988	Kiernan et al.	206/705
5,188,231	*	2/1993	Kivell et al.	206/705
5,484,631	*	1/1996	Hoh	206/461
5,819,939	*	10/1998	Boyer	206/806 X
5,899,333	*	5/1999	Williams et al.	206/705

FOREIGN PATENT DOCUMENTS

83658 4/1998 (CA) .

OTHER PUBLICATIONS

Techform Inc., Nov. 1982.*

* cited by examiner

Primary Examiner—Prabhakar Deshmukh

(74) *Attorney, Agent, or Firm*—Stewart A. Fraser

(57) **CLAIM**

I claim the ornamental design for a battery package, as shown and described.

DESCRIPTION

FIG. 1 is a perspective view of a battery package showing the new design;

FIG. 2 is a front elevational view of FIG. 1;

FIG. 3 is a right side elevational view of FIG. 1;

FIG. 4 is a left side elevational view of FIG. 1;

FIG. 5 is a back elevational view of FIG. 1;

FIG. 6 is a top plan view of FIG. 1;

FIG. 7 is a bottom view of FIG. 1;

FIG. 8 is a perspective view of a second embodiment of FIG. 1;

FIG. 9 is a front elevational view of FIG. 8;

FIG. 10 is a right side elevational view of FIG. 8;

FIG. 11 is a left side elevational view of FIG. 8;

FIG. 12 is a back elevational view of FIG. 8;

FIG. 13 is a top plan view of FIG. 8; and,

FIG. 14 is a bottom view of FIG. 8.

The broken lines showing of blister and eyelet is for illustrative purpose only and forms no part of the claimed design.

1 Claim, 4 Drawing Sheets

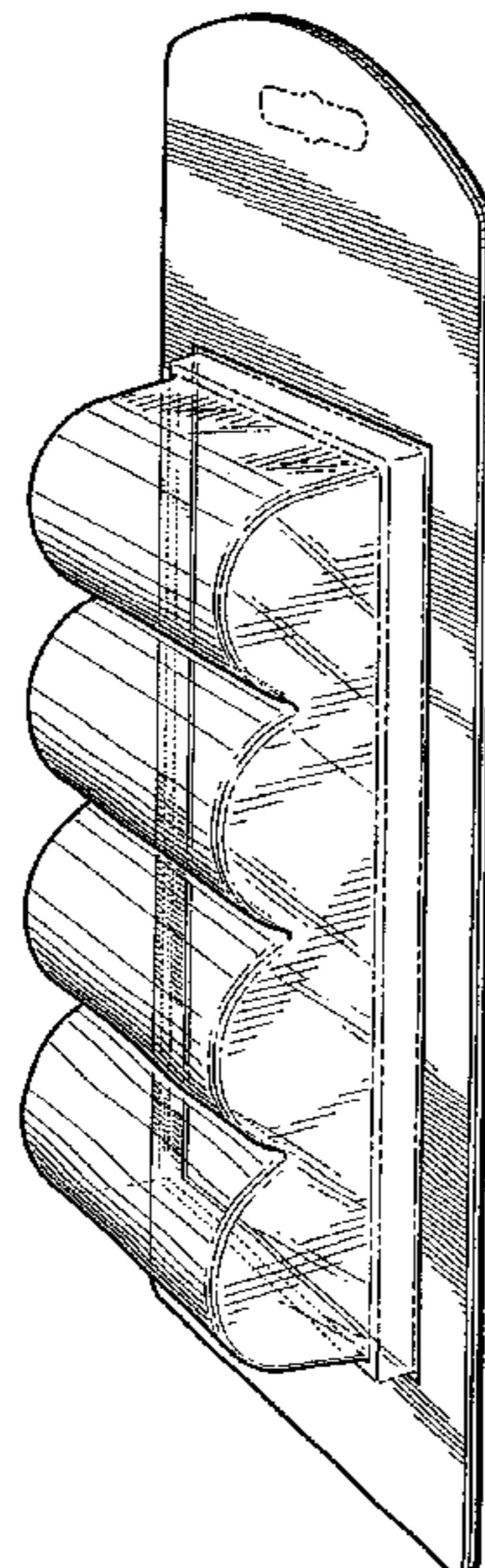

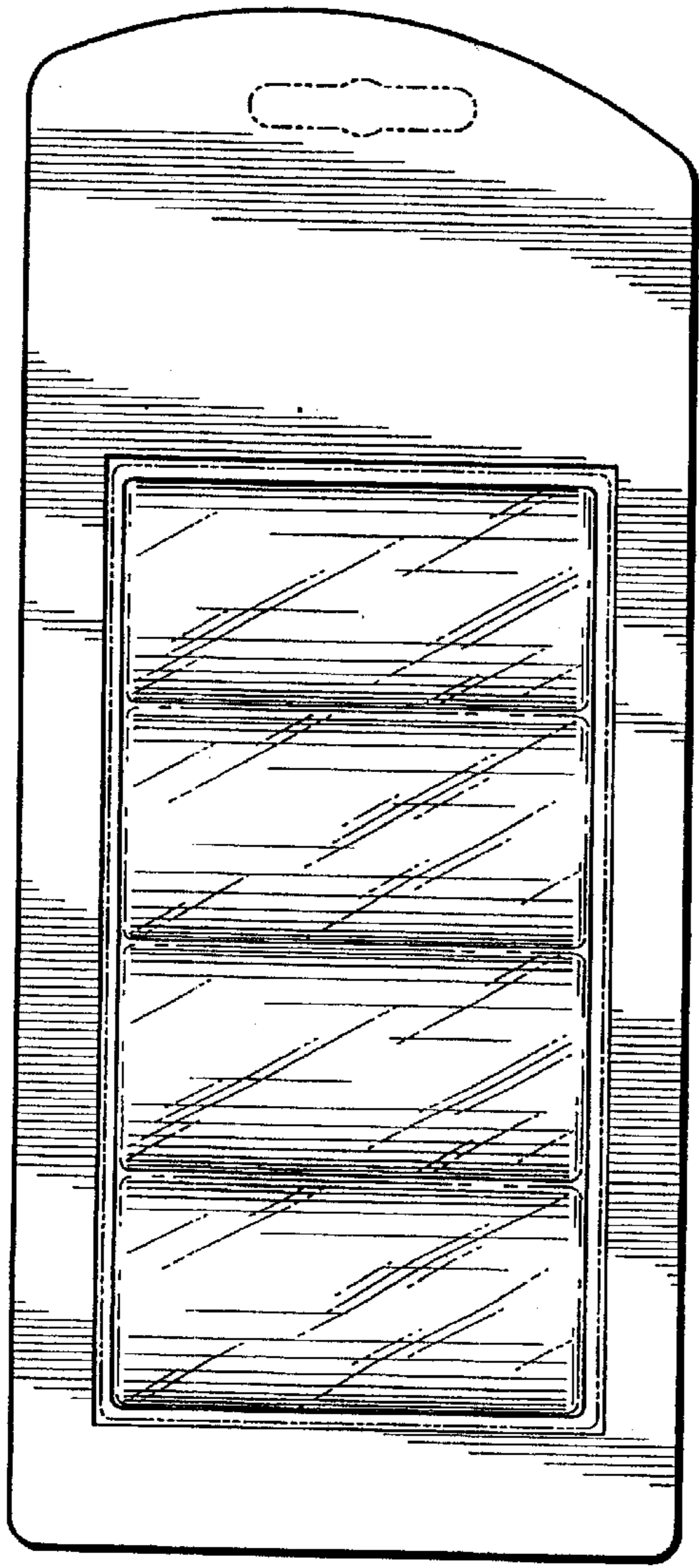

Fig. 2

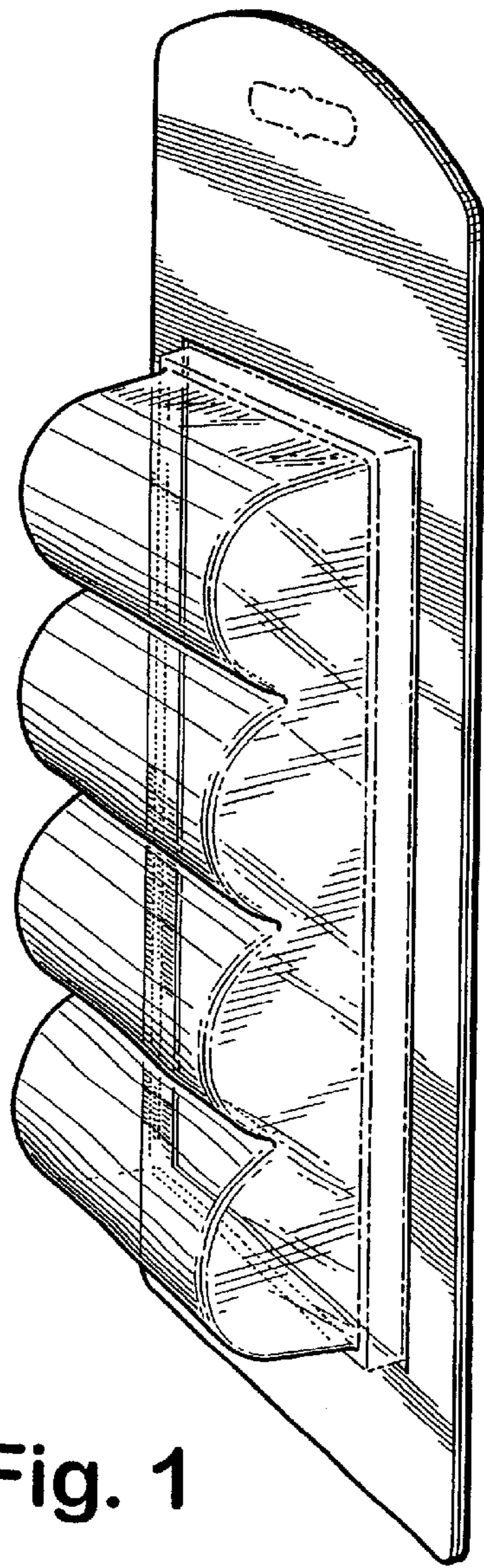

Fig. 1

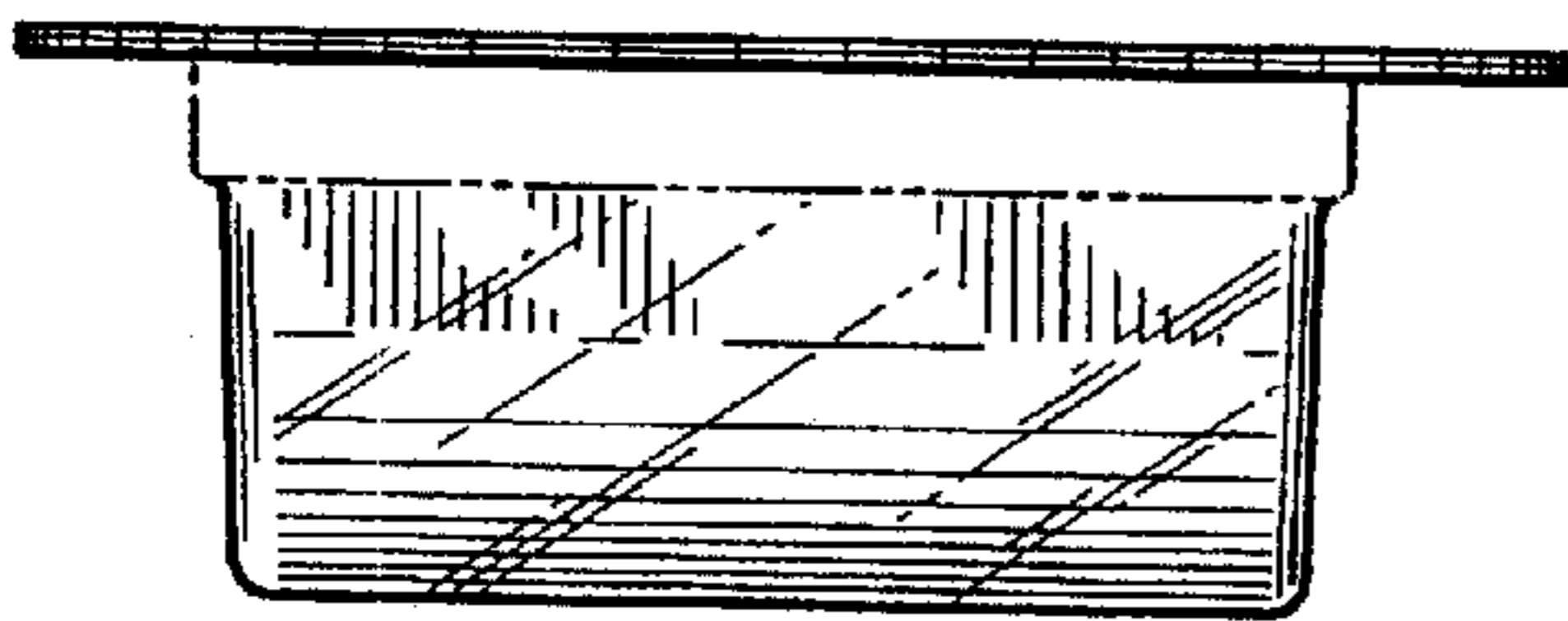

Fig. 6

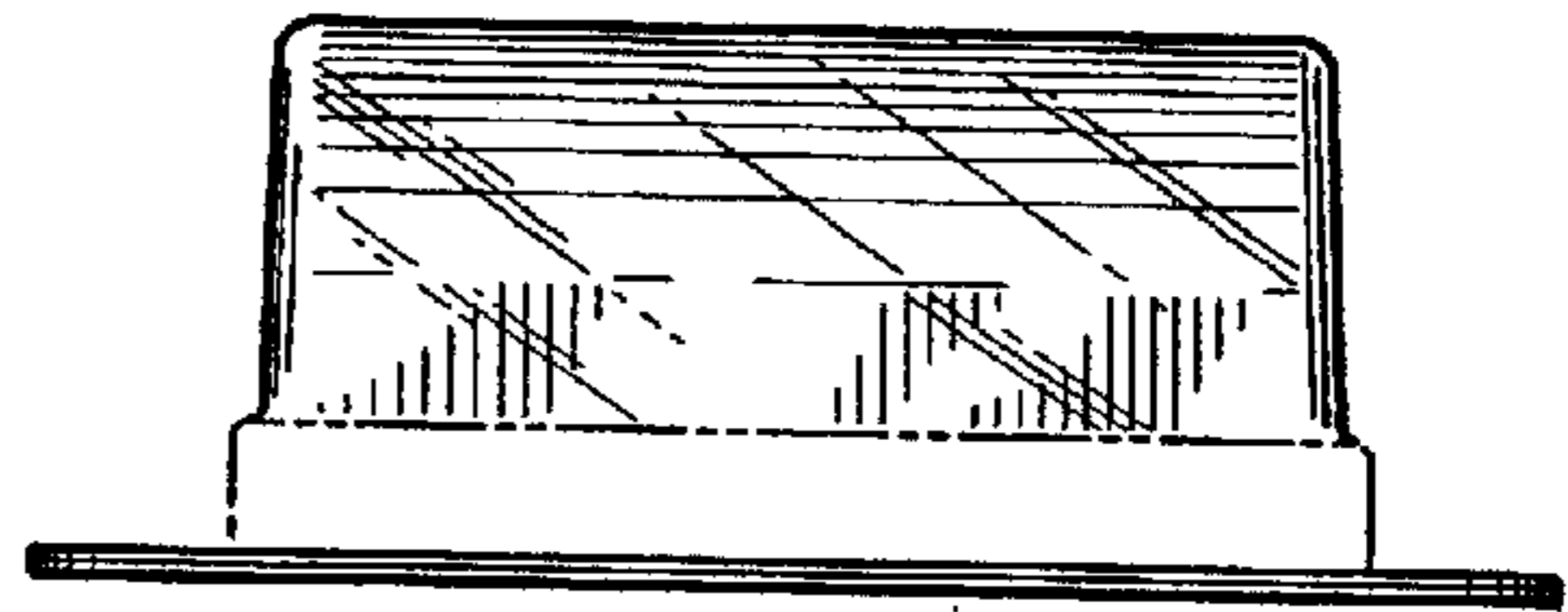

Fig. 7

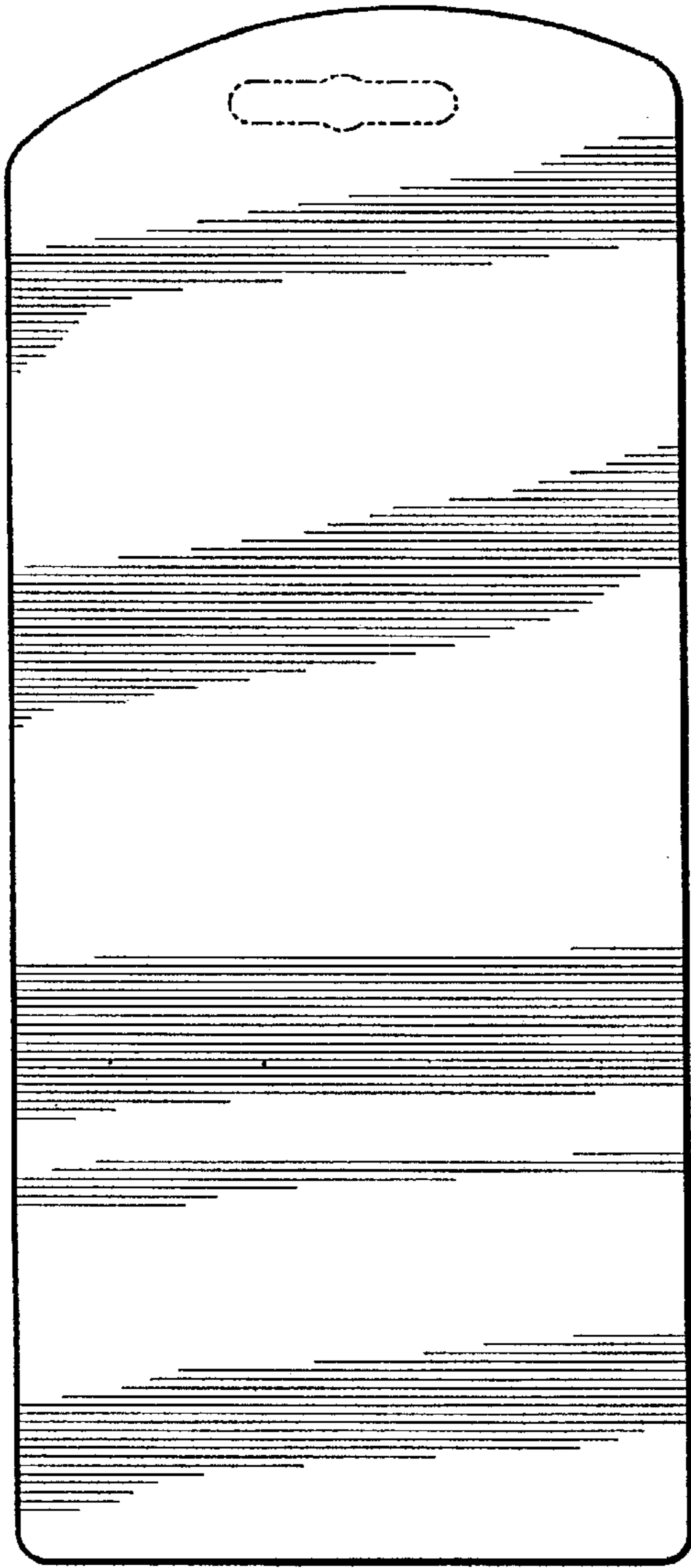

Fig. 5

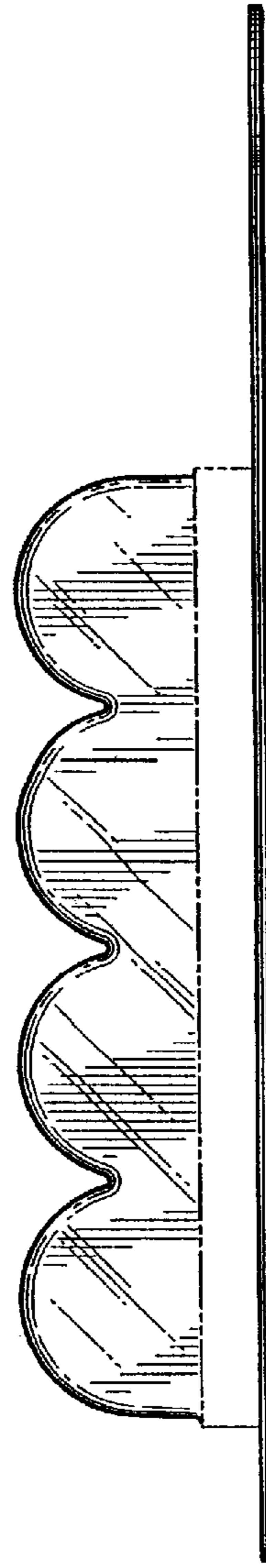

Fig. 3

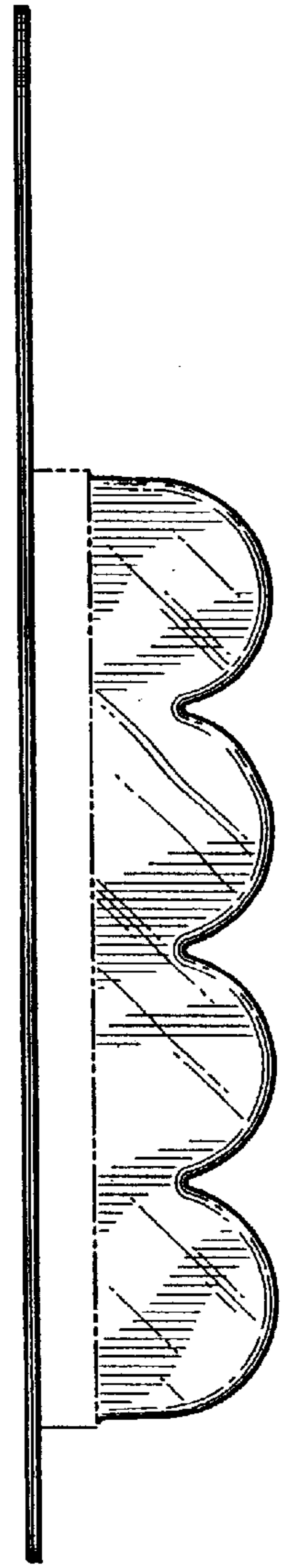

Fig. 4

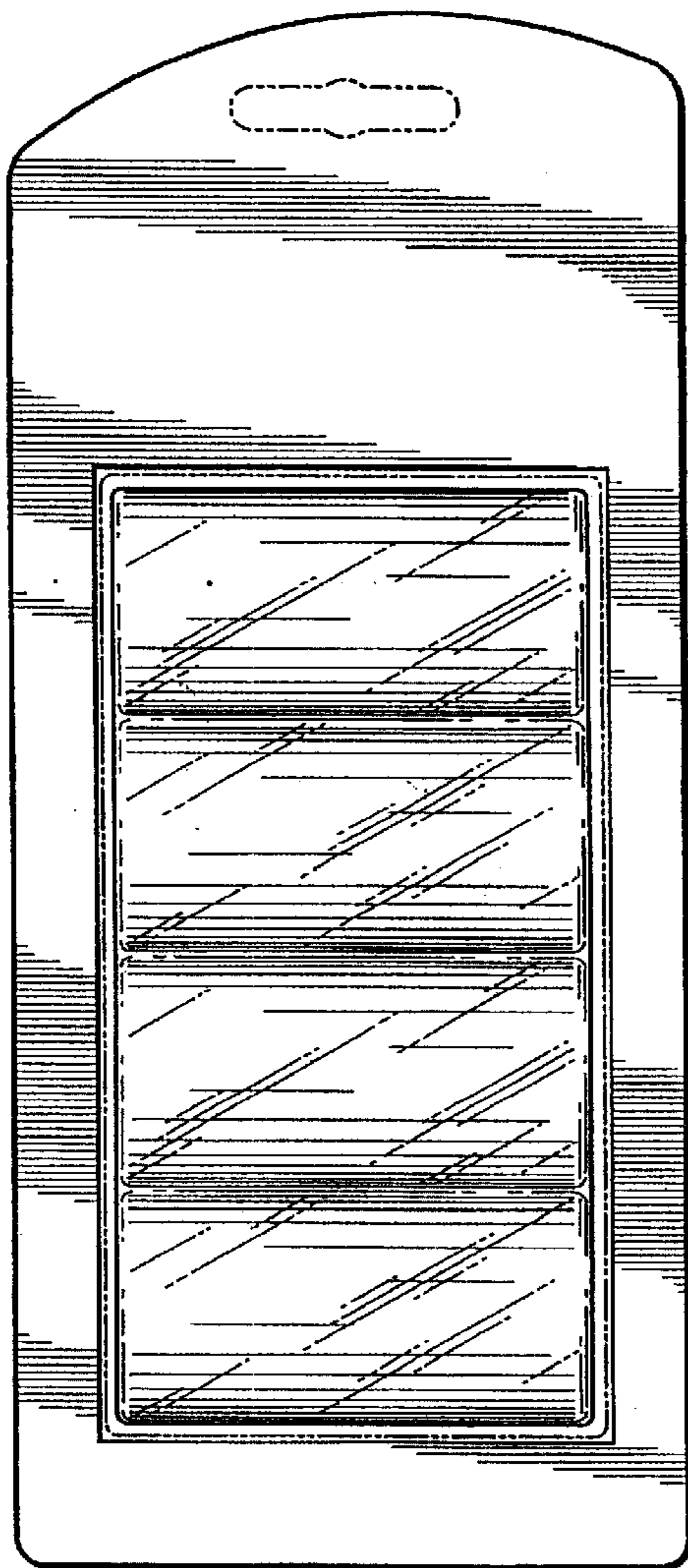

Fig. 9

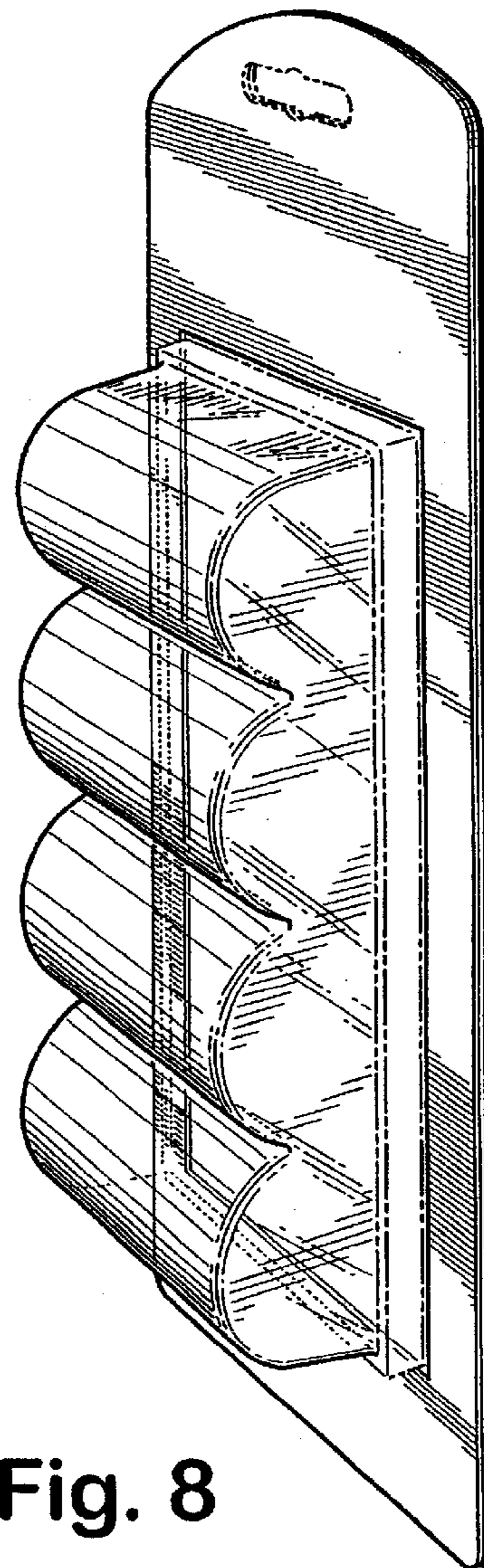

Fig. 8

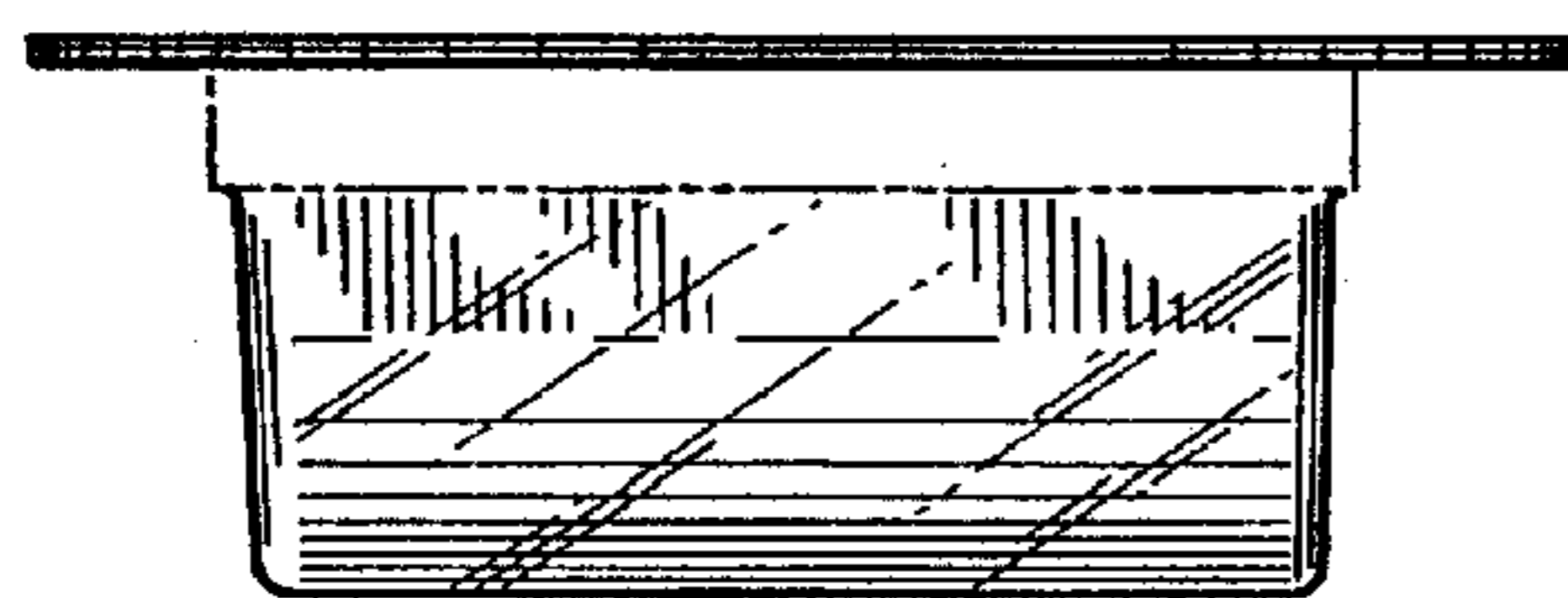

Fig. 13

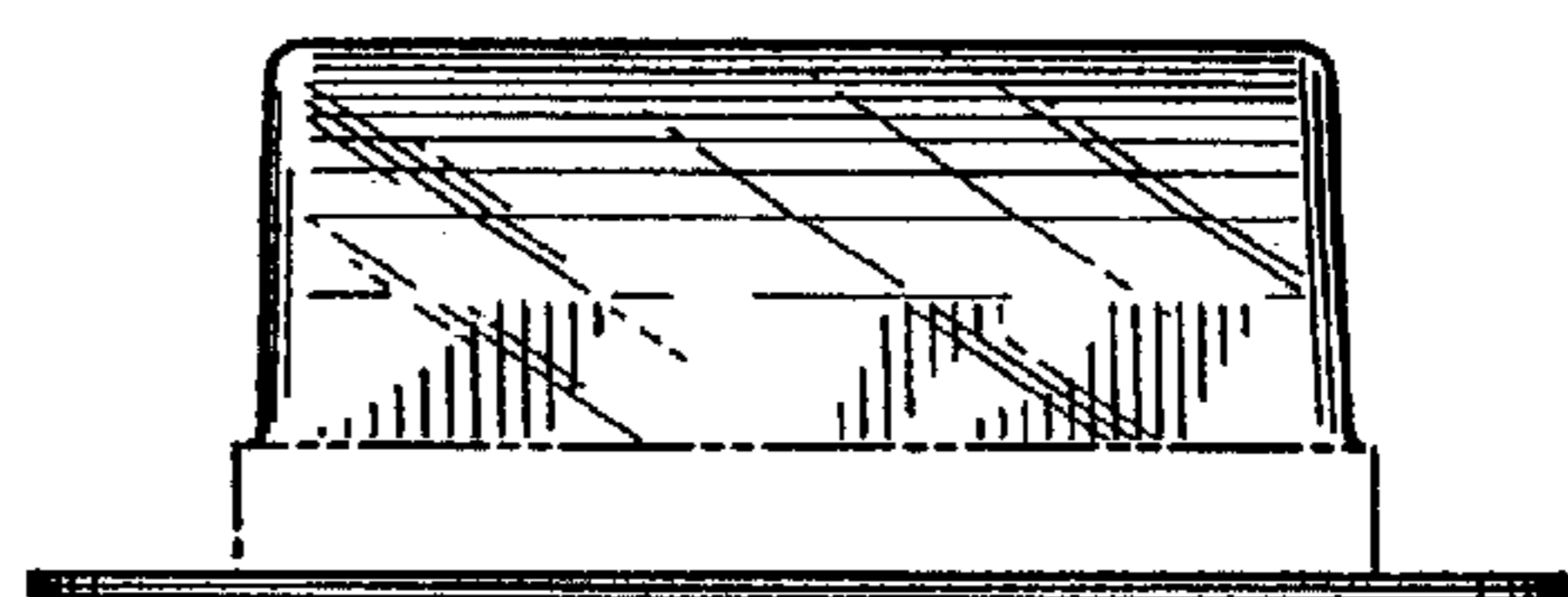

Fig. 14

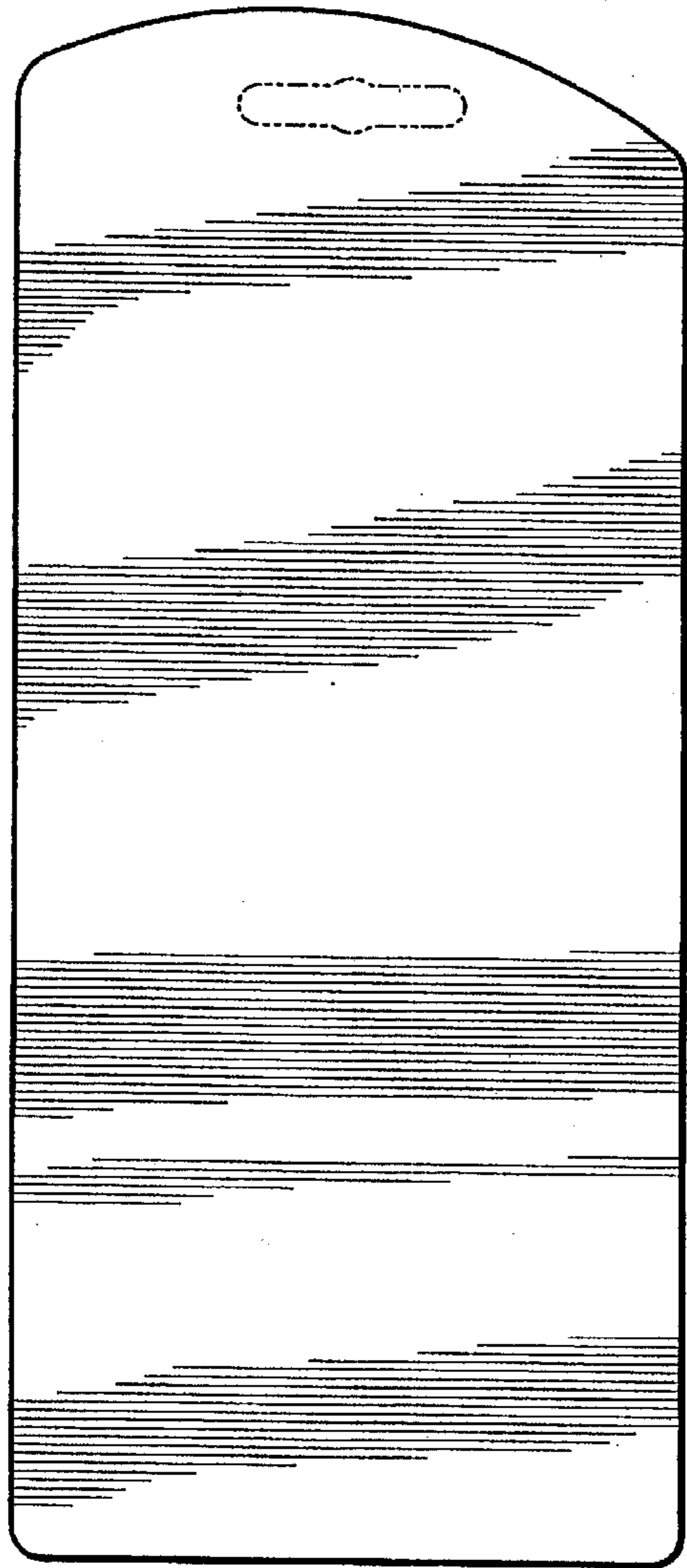

Fig. 12

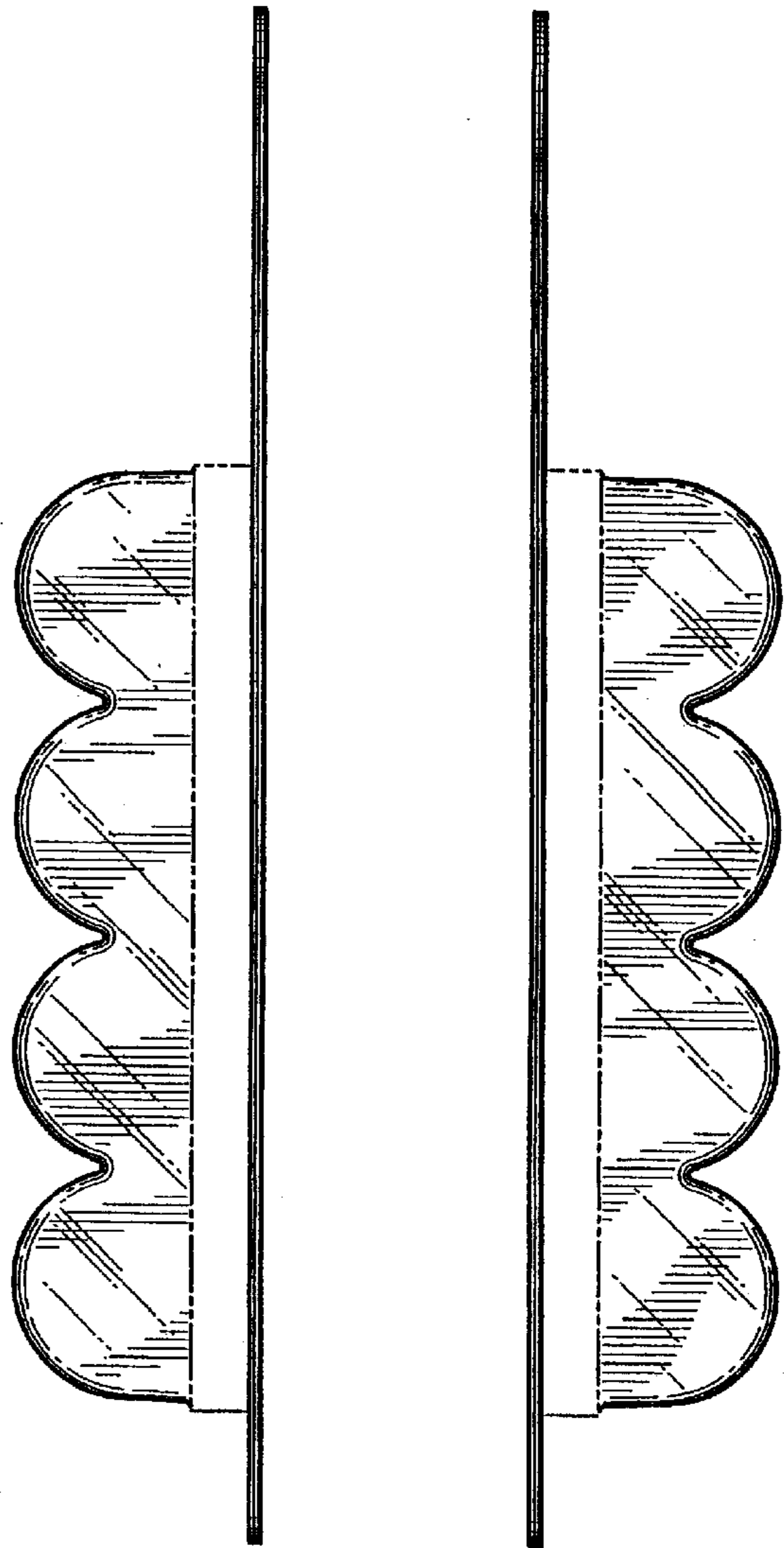

Fig. 10

Fig. 11