



US00D450160B1

(12) **United States Design Patent**
Kalhok

(10) **Patent No.:** **US D450,160 S**

(45) **Date of Patent:** **** Nov. 6, 2001**

(54) **FULL-FACE HELMET**

(75) Inventor: **David Kalhok**, Georgeville (CA)

(73) Assignee: **Bombardier Inc.**, Montreal (CA)

(**) Term: **14 Years**

(21) Appl. No.: **29/099,598**

(22) Filed: **Jan. 25, 1999**

(51) **LOC (7) Cl.** **29-02**

(52) **U.S. Cl.** **D29/107**

(58) **Field of Search** D29/102-107,
D29/122; 2/414, 418, 423, 424, 425, 9,
455

(56) **References Cited**

U.S. PATENT DOCUMENTS

H1039	4/1992	Tripp, Jr. et al. .	
D. 312,513	* 11/1990	Morin	D29/107
D. 334,250	* 3/1993	Gallet	D29/107
D. 340,545	* 10/1993	Kamata	D29/107

(List continued on next page.)

FOREIGN PATENT DOCUMENTS

0371858 6/1990 (EP) .

Primary Examiner—Ruth McInroy

(74) *Attorney, Agent, or Firm*—Pillsbury Winthrop LLP

(57) **CLAIM**

I claim the ornamental design for a full-face helmet, as shown and described.

DESCRIPTION

FIG. 1 is a front perspective view of a full-face helmet showing my new design;

FIG. 2 is a front elevational view thereof;
 FIG. 3 is a right side elevational view thereof;
 FIG. 4 is a top plan view thereof;
 FIG. 5 is a left side elevational view thereof;
 FIG. 6 is a bottom plan view thereof;
 FIG. 7 is a rear elevational view thereof;
 FIG. 8 is a front perspective view of a second embodiment thereof;
 FIG. 9 is a front elevational of FIG. 8;
 FIG. 10 is a right side elevational view of FIG. 8;
 FIG. 11 is a top plan view of FIG. 8;
 FIG. 12 is a left side elevational view of FIG. 8;
 FIG. 13 is a bottom plan view of FIG. 8;
 FIG. 14 is a rear elevational view of FIG. 8;
 FIG. 15 is a front perspective view of a third embodiment thereof;
 FIG. 16 is a front elevational of FIG. 15;
 FIG. 17 is a right side elevational view of FIG. 15;
 FIG. 18 is a top plan view of FIG. 15;
 FIG. 19 is a left side elevational view of FIG. 15;
 FIG. 20 is a bottom plan view of FIG. 15; and,
 FIG. 21 is a rear elevational view of FIG. 15.

The broken lines are for illustrative purposes only and form no part of the claimed design.

1 Claim, 12 Drawing Sheets

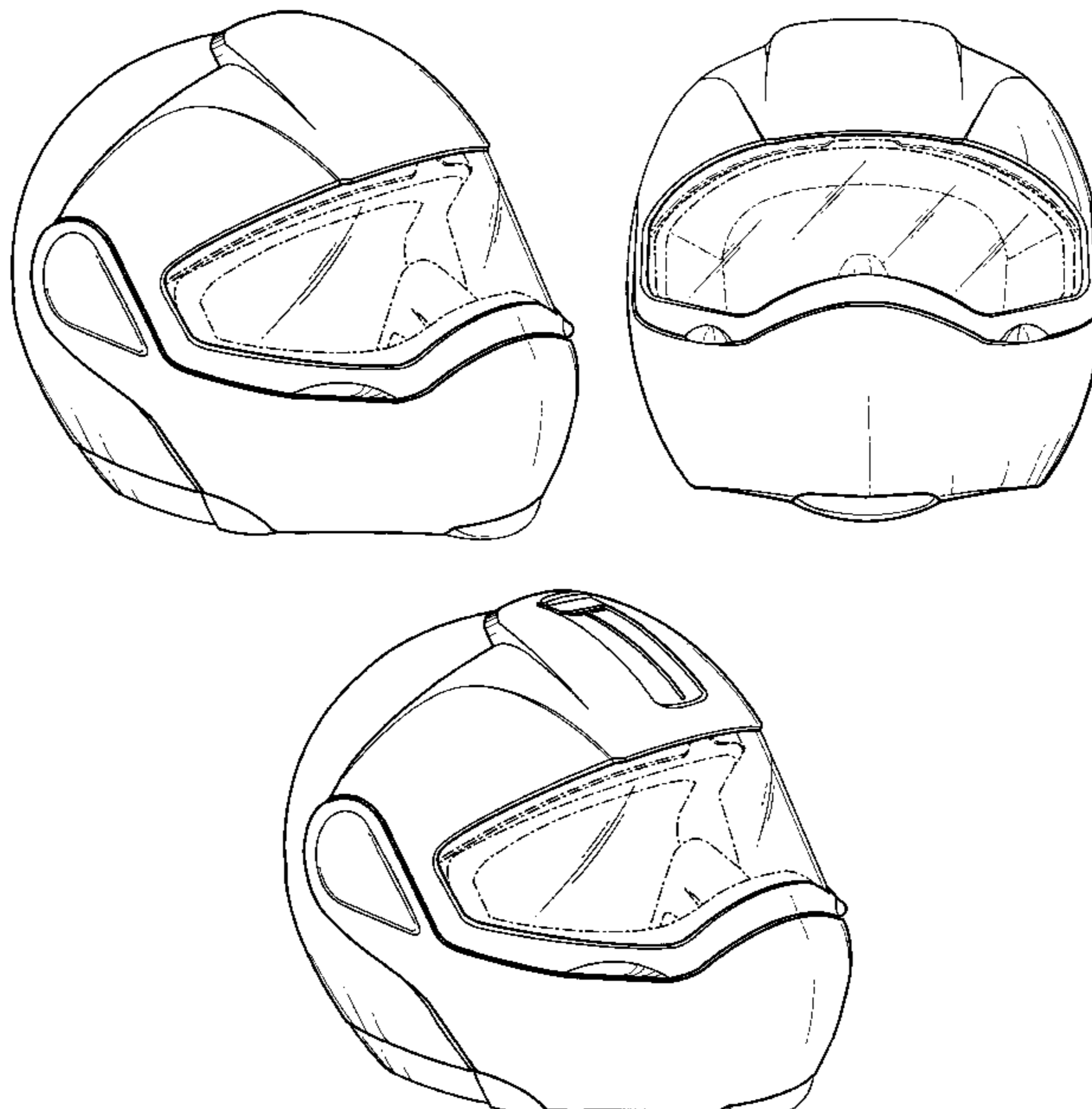

US D450,160 S

Page 2

U.S. PATENT DOCUMENTS							
D. 340,546	*	10/1993	Kamata	D29/107	4,667,348	5/1987	Sundahl .
D. 351,685	*	10/1994	Kamata	D29/105	4,676,236	6/1987	Piorowski et al. .
D. 361,867	*	8/1995	Taniuchi	D29/102	4,689,836	9/1987	Vitaloni .
D. 406,403	*	3/1999	Simpson	D29/107	4,734,940	4/1988	Galet et al. .
D. 411,900	*	7/1999	Puleo	D29/107	4,803,980	2/1989	Nowakowski et al. .
D. 418,255	*	12/1999	Hohdorf	D29/107	5,003,632	4/1991	Claude .
1,706,602		3/1929	Drager .		5,078,130	1/1992	Van Oosten et al. .
2,317,608		4/1943	Heidbrink .		5,093,939	3/1992	Noyerie et al. .
2,348,277		5/1944	Boothby et al. .		5,187,502	2/1993	Howell .
2,867,812		1/1959	Roth et al. .		5,291,880	3/1994	Almovist et al. .
3,065,747		11/1962	Forkel .		5,394,566	3/1995	Hong .
3,110,034		11/1963	Aileo .		5,500,953	3/1996	Reuber et al. .
3,237,202		3/1966	Aileo .		5,515,843	5/1996	Chang .
3,239,843		3/1966	Lobelle .		5,549,104	8/1996	Crump et al. .
3,310,811		3/1967	Iacono, Jr. .		5,555,569	9/1996	Lane .
3,400,407		9/1968	Aileo .		5,584,073	12/1996	Radzelovage et al. .
3,721,994		3/1973	DeSimone et al. .		5,603,317	2/1997	Farmer .
3,768,100		10/1973	Colman et al. .		5,619,755	4/1997	Casartelli .
3,833,935		9/1974	Ansite et al. .		5,630,412	5/1997	Dubruille et al. .
3,971,368		7/1976	Forbes et al. .		5,653,225	8/1997	Schegerin .
4,170,042		10/1979	Aileo .		5,694,650	12/1997	Hong .
4,315,335		2/1982	Kennedy, Jr. et al. .		5,722,091	3/1998	Keller et al. .
4,555,815		12/1985	Walther .		5,758,639	6/1998	Ikonen .
4,556,994		12/1985	Kawasaki et al. .		5,765,235	6/1998	Arnold .
4,579,113		4/1986	McCreadie et al. .		5,794,260	8/1998	Schegerin .
4,584,721		4/1986	Yamamoto .		5,797,146	8/1998	Matich .
4,595,003		6/1986	Shoemaker et al. .		5,924,420	7/1999	Reischel et al. .
4,598,430		7/1986	Nava .				

* cited by examiner

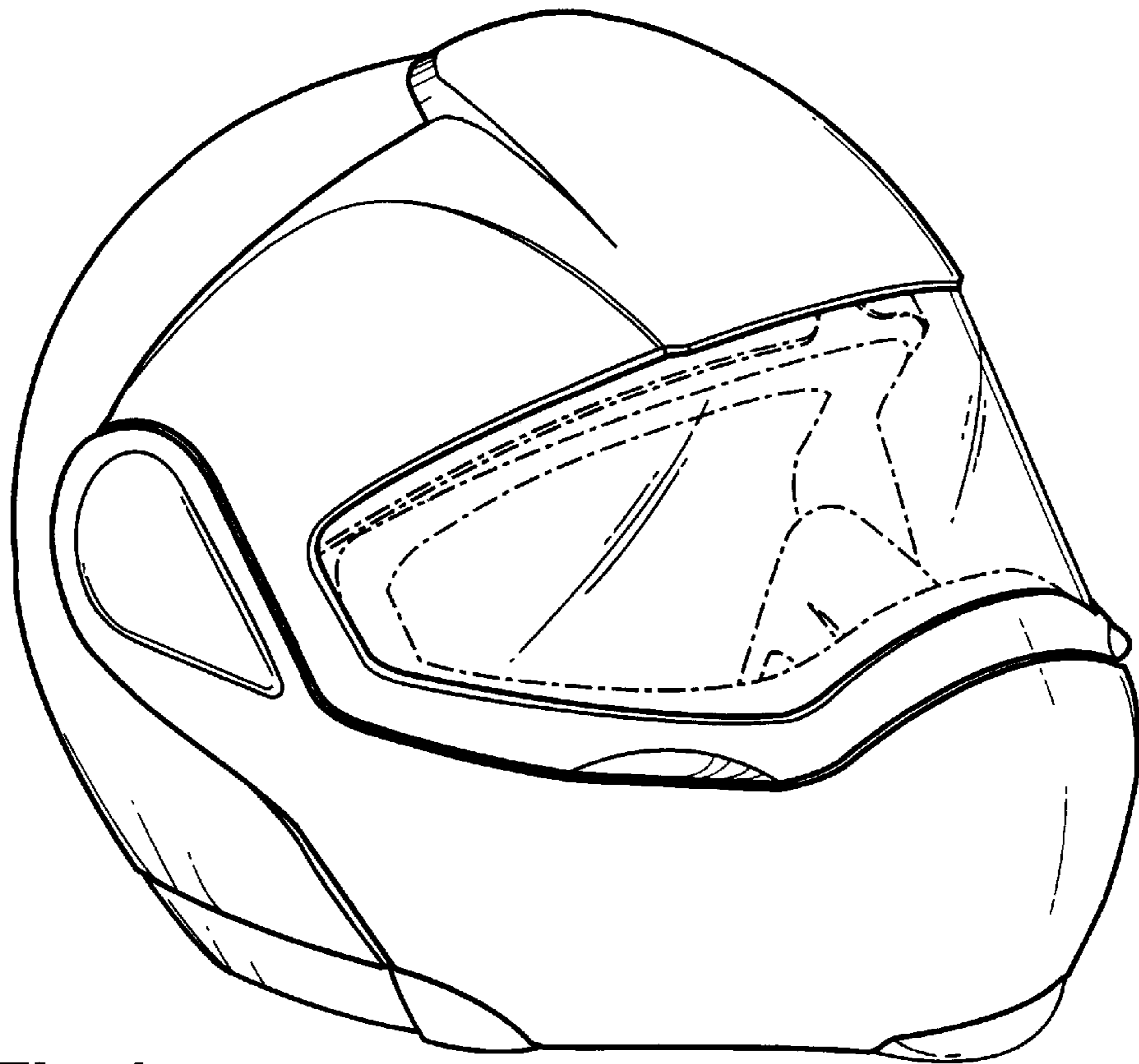

Fig.1

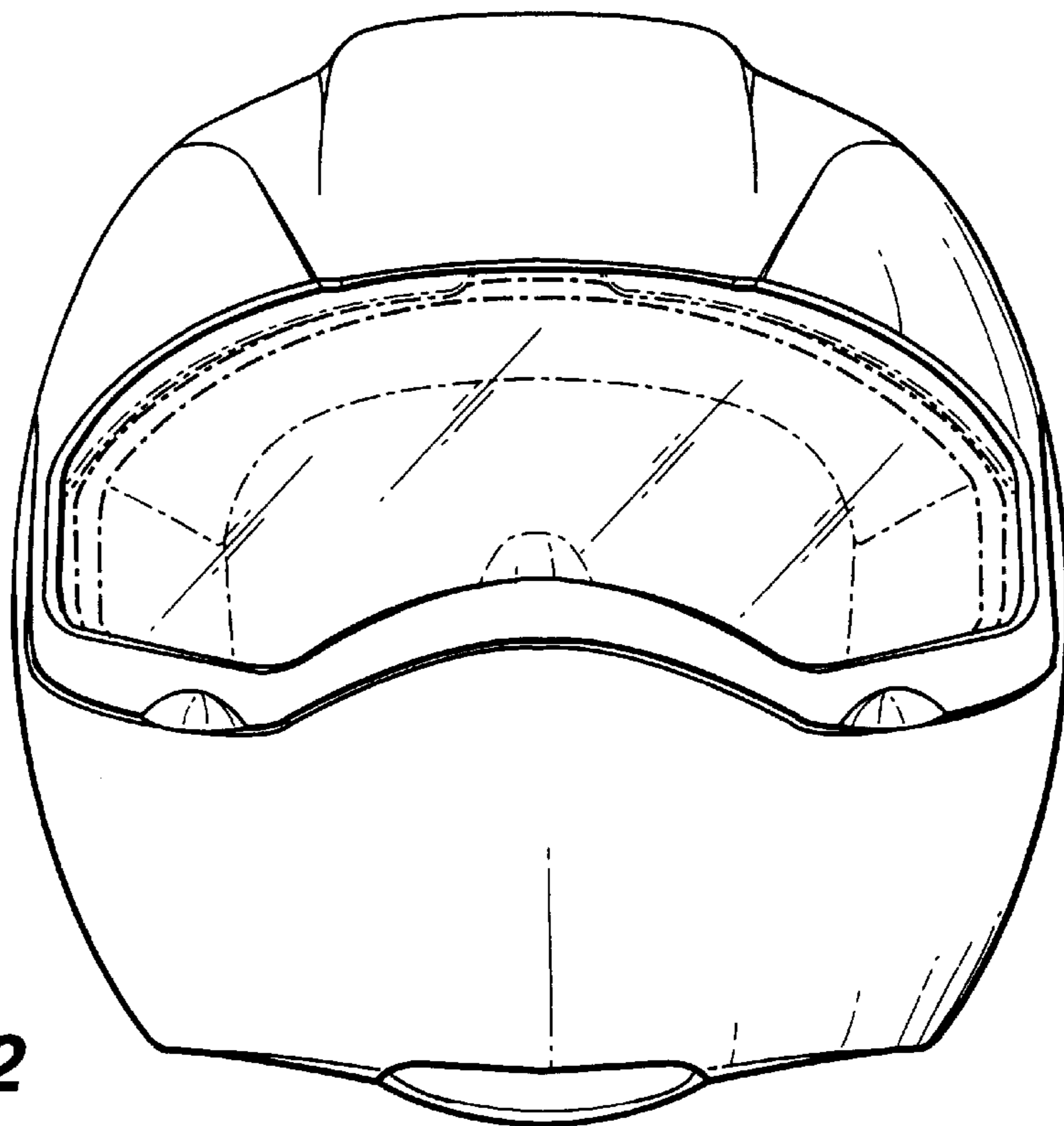

Fig.2

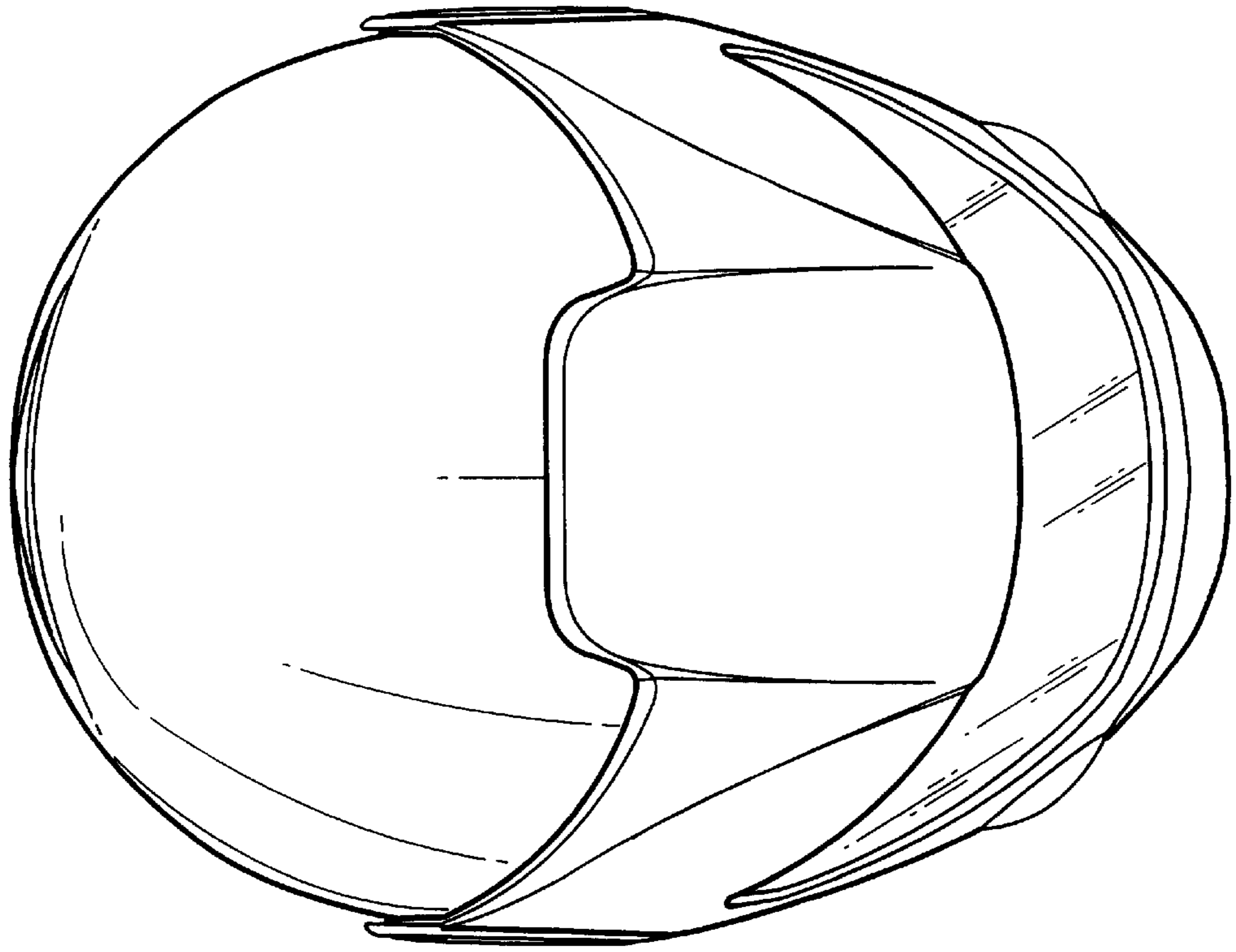

Fig.4

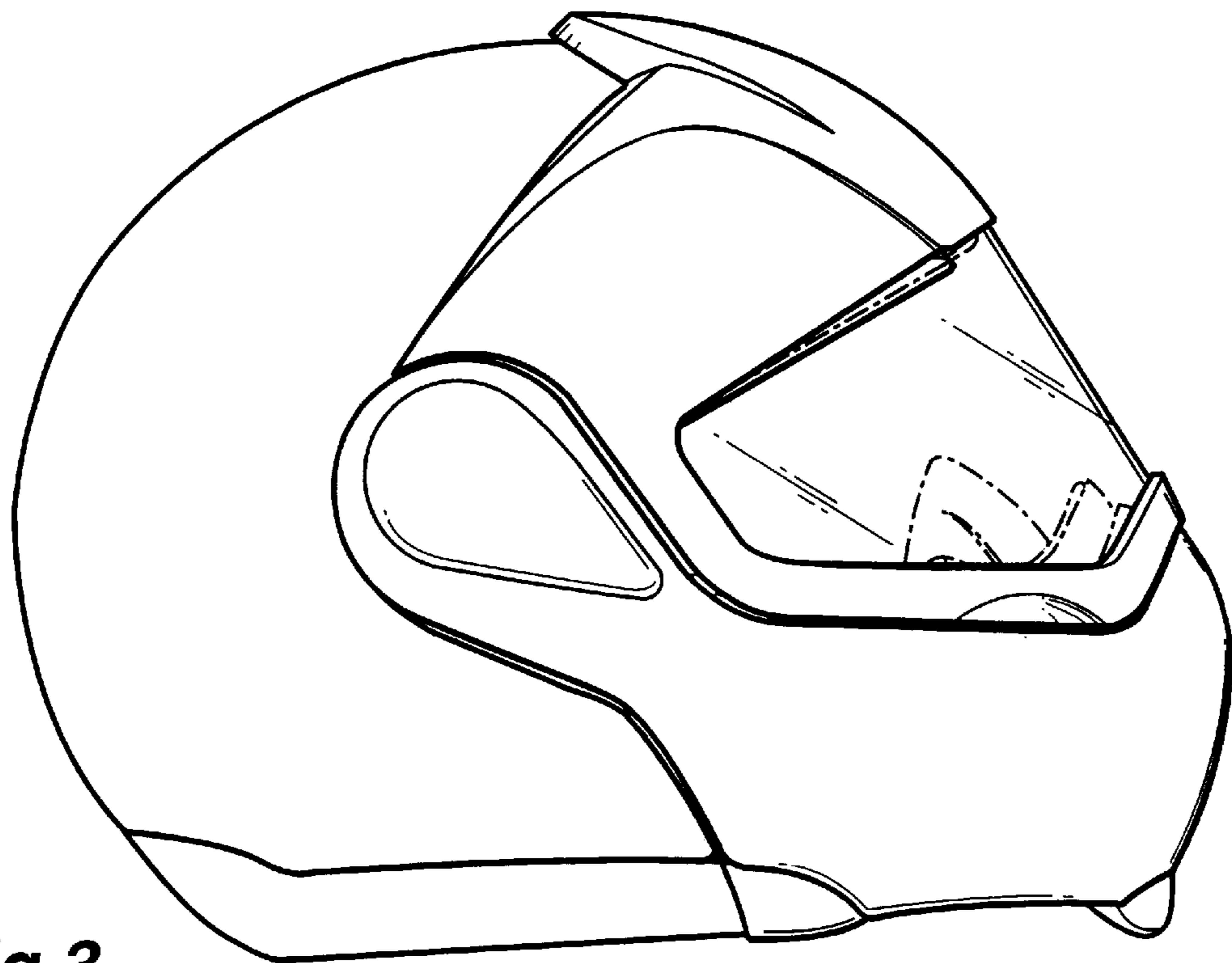

Fig.3

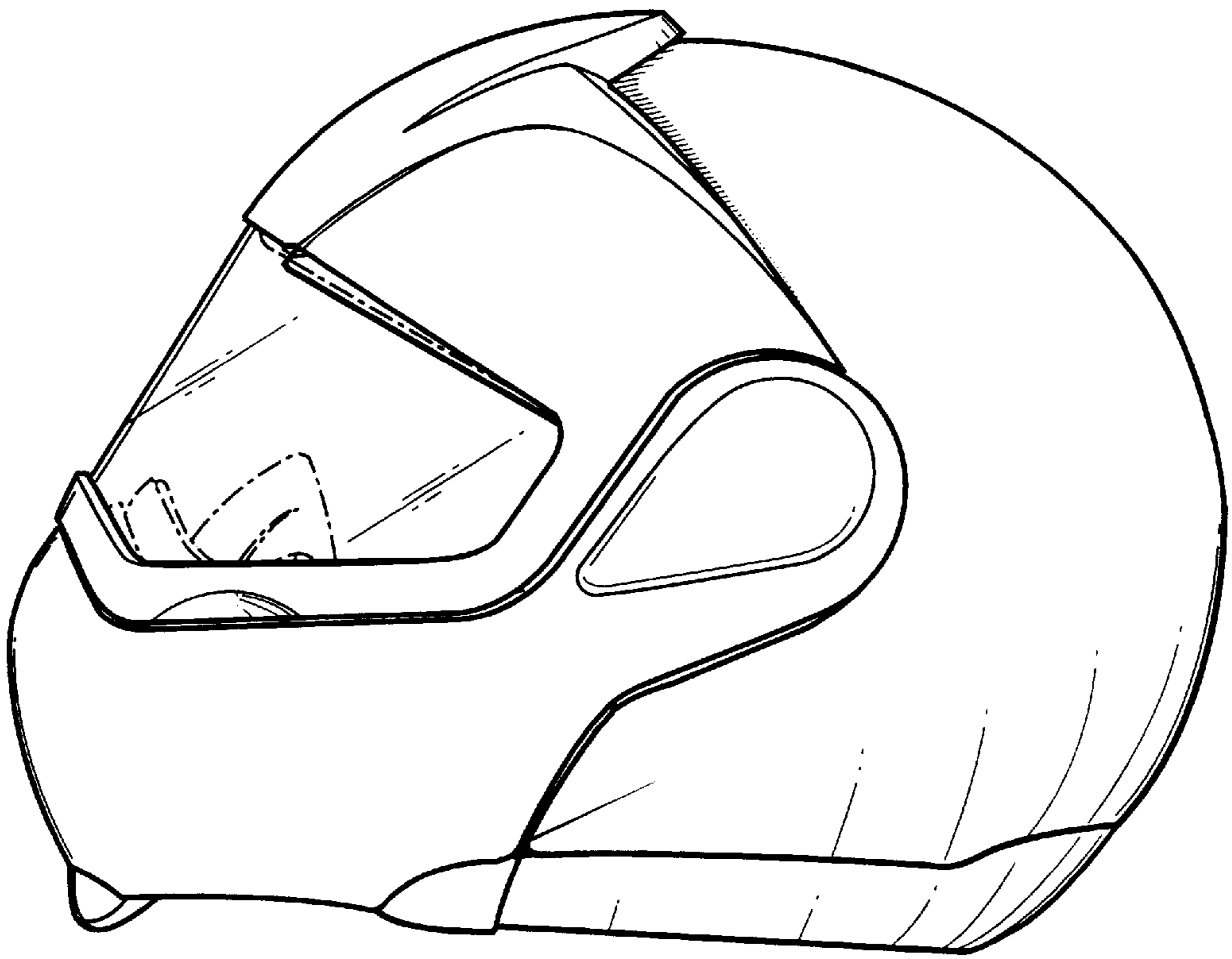

Fig.5

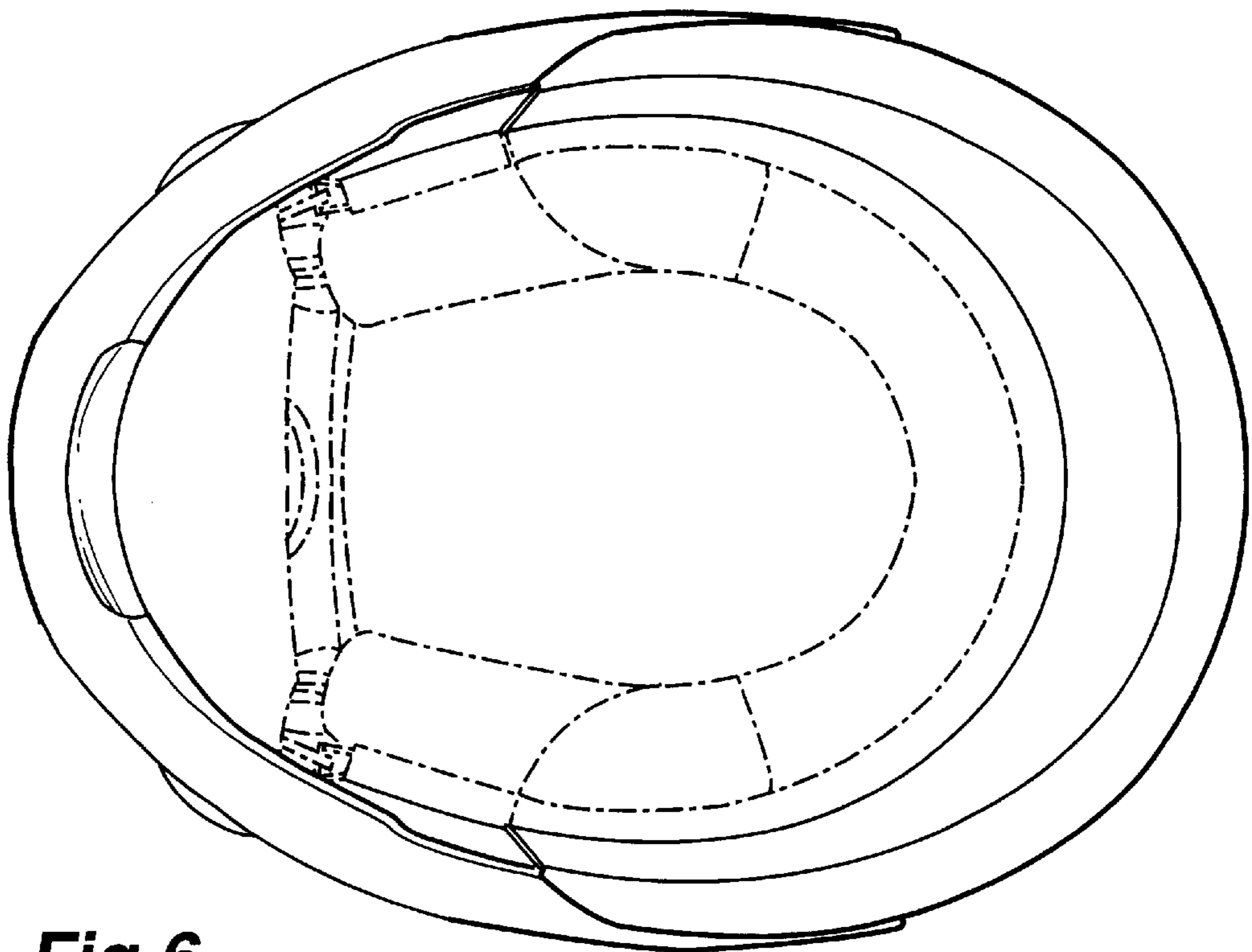

Fig.6

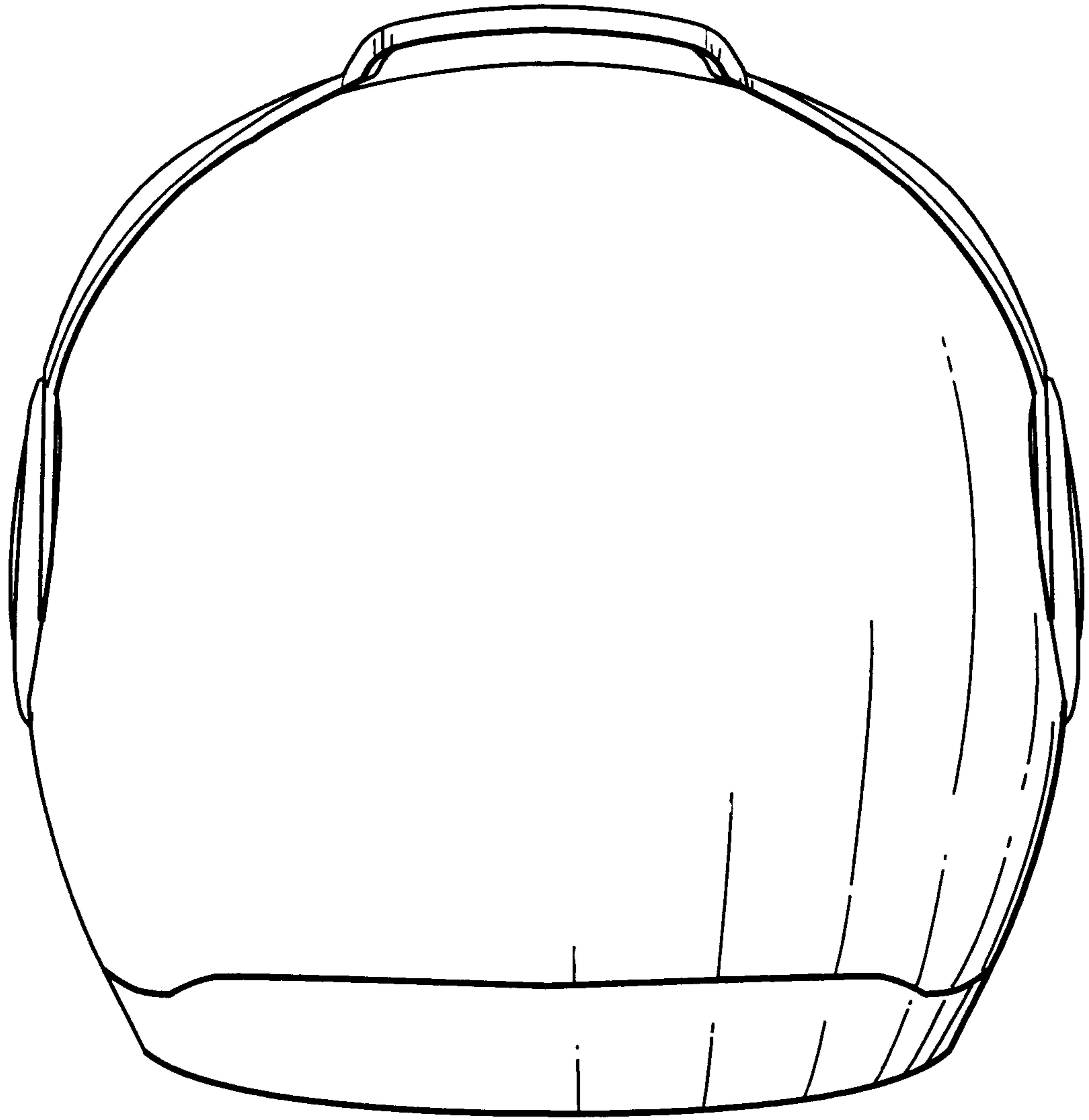

Fig.7

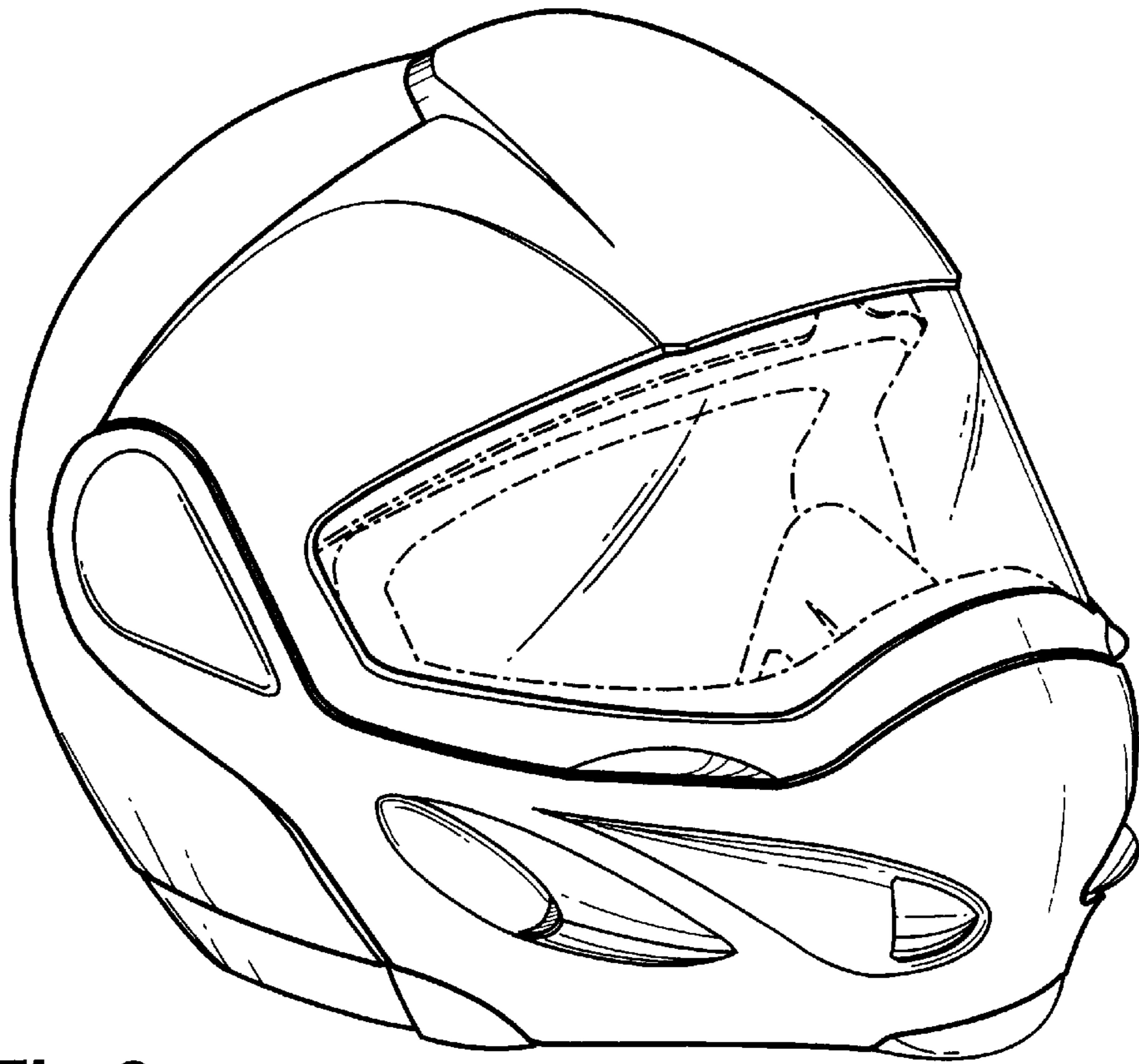

Fig.8

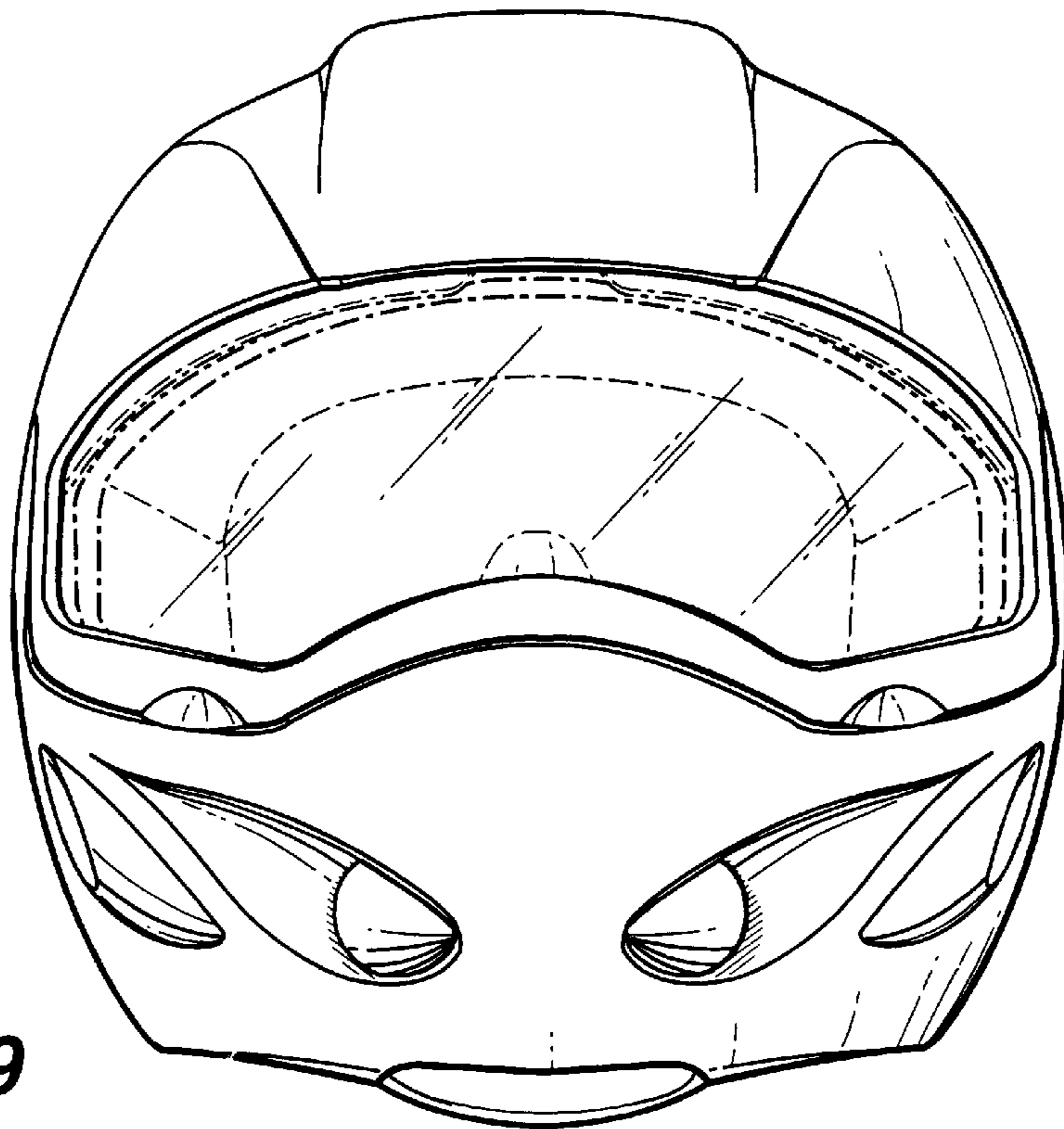

Fig.9

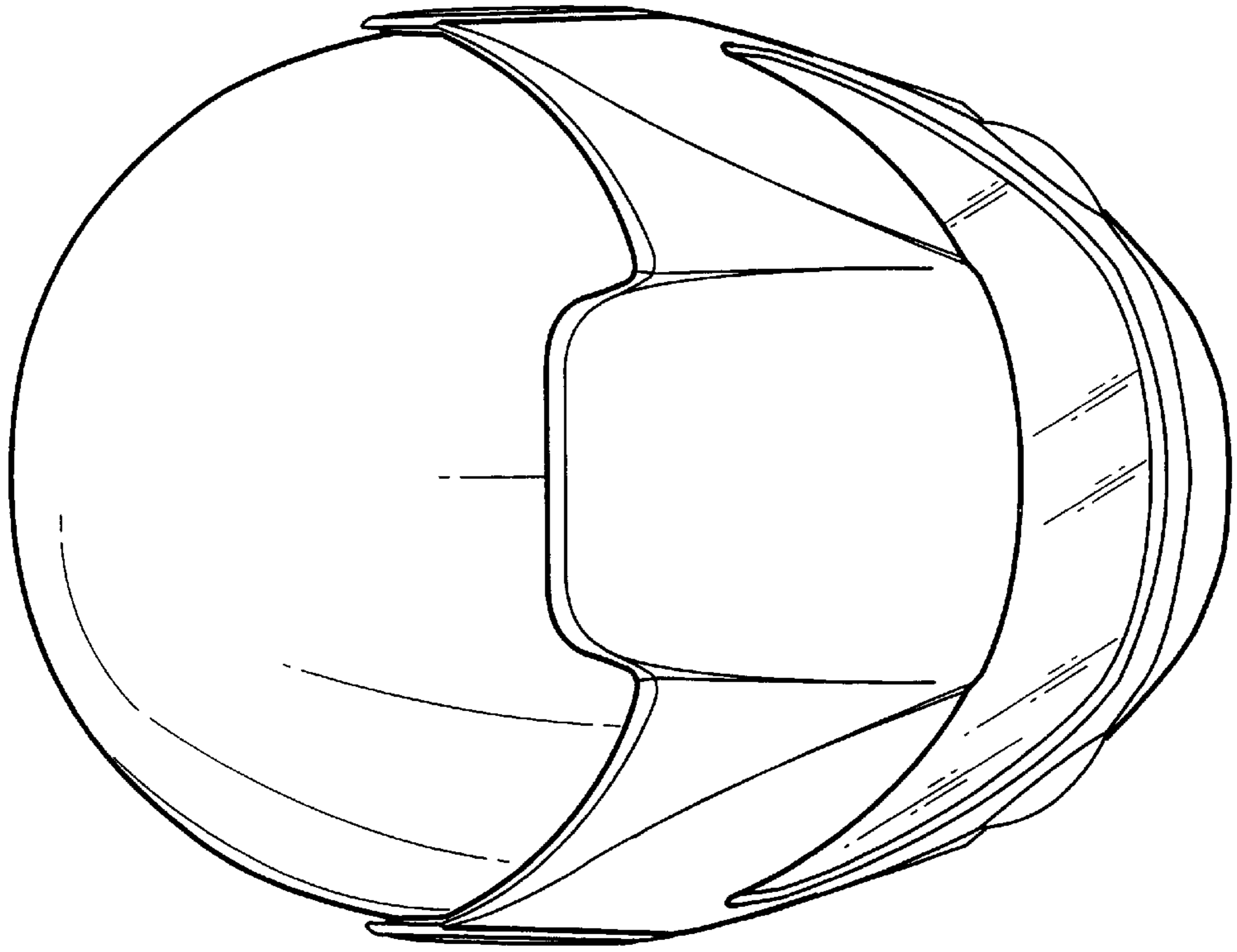

Fig.11

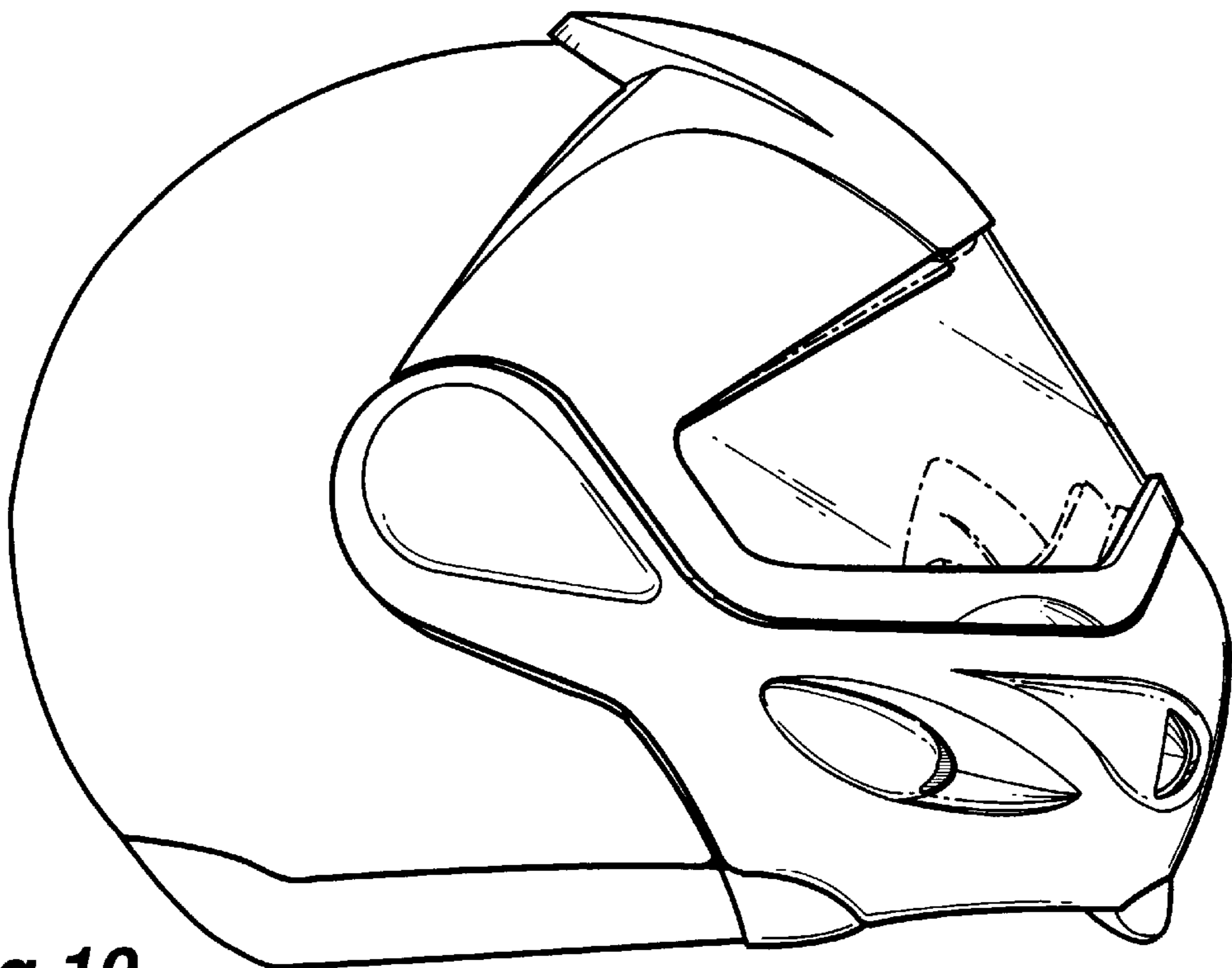

Fig.10

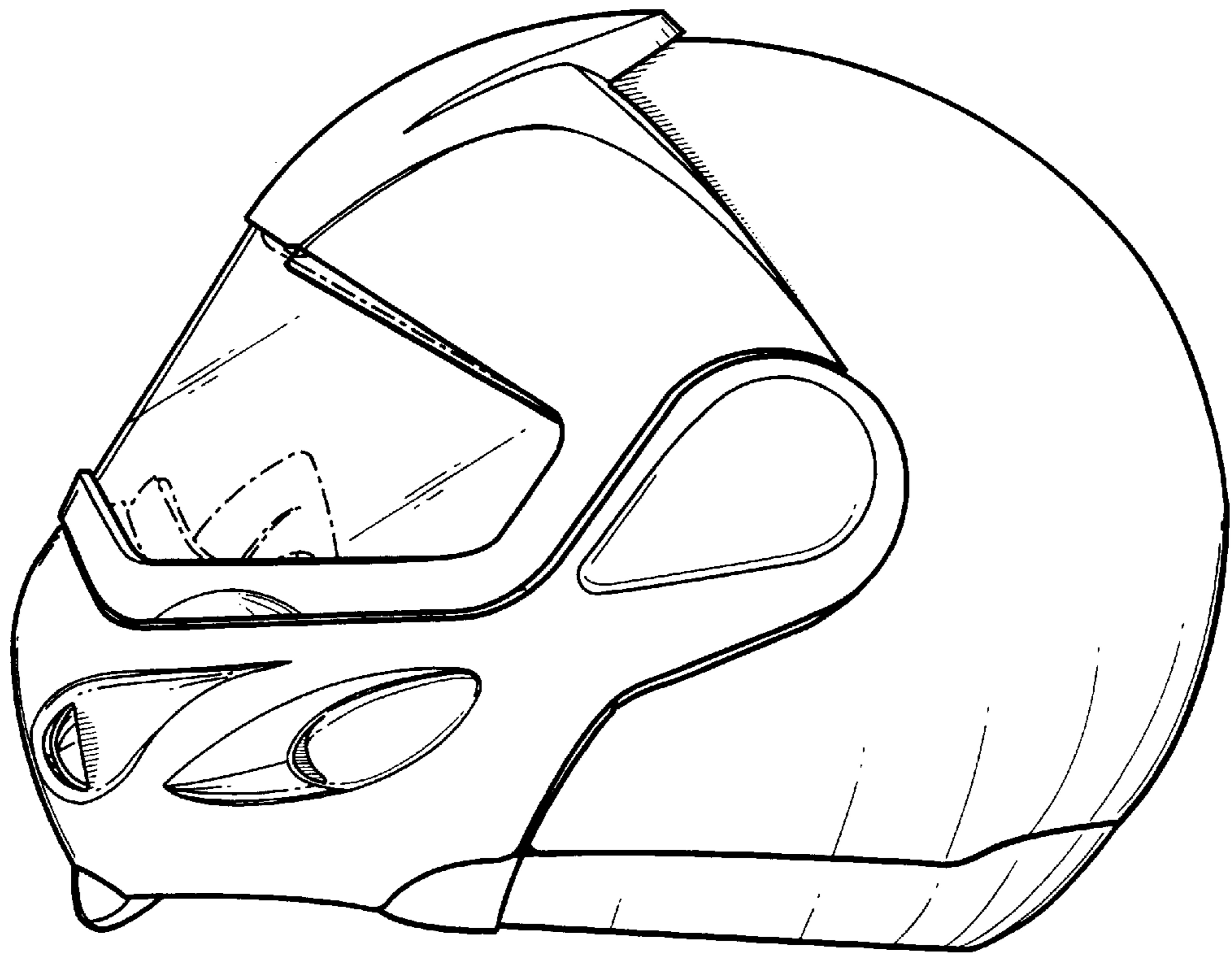

Fig. 12

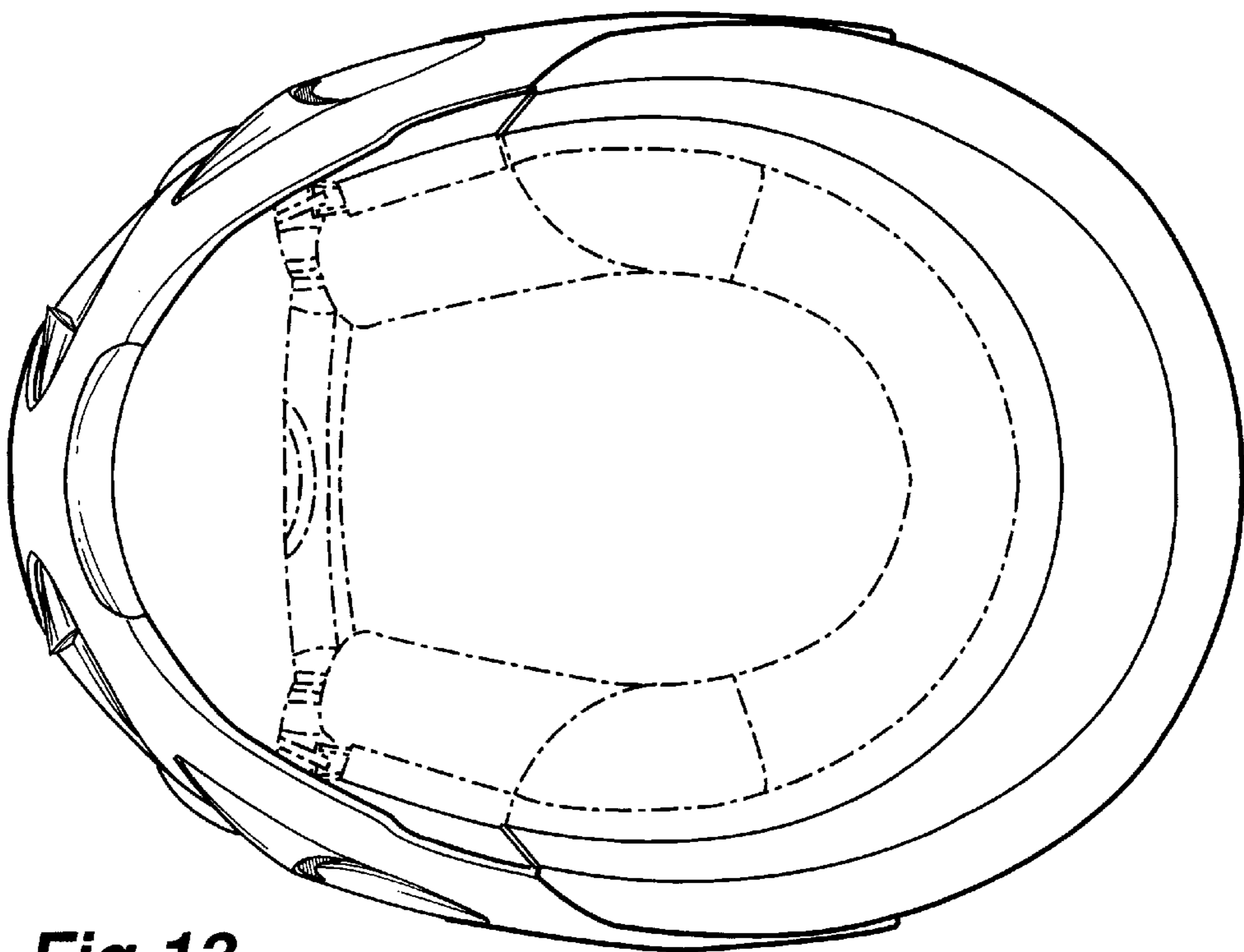

Fig. 13

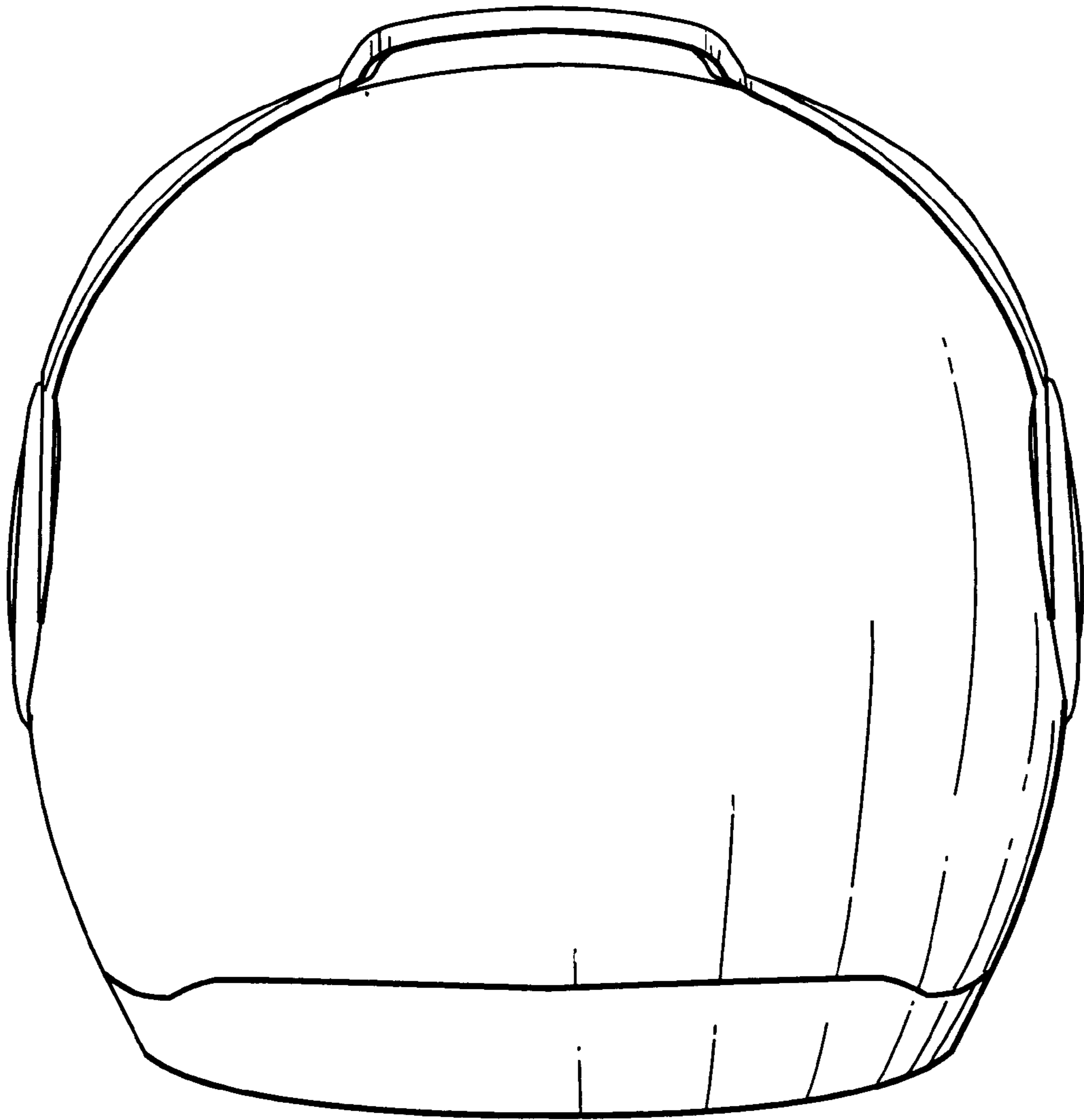

Fig. 14

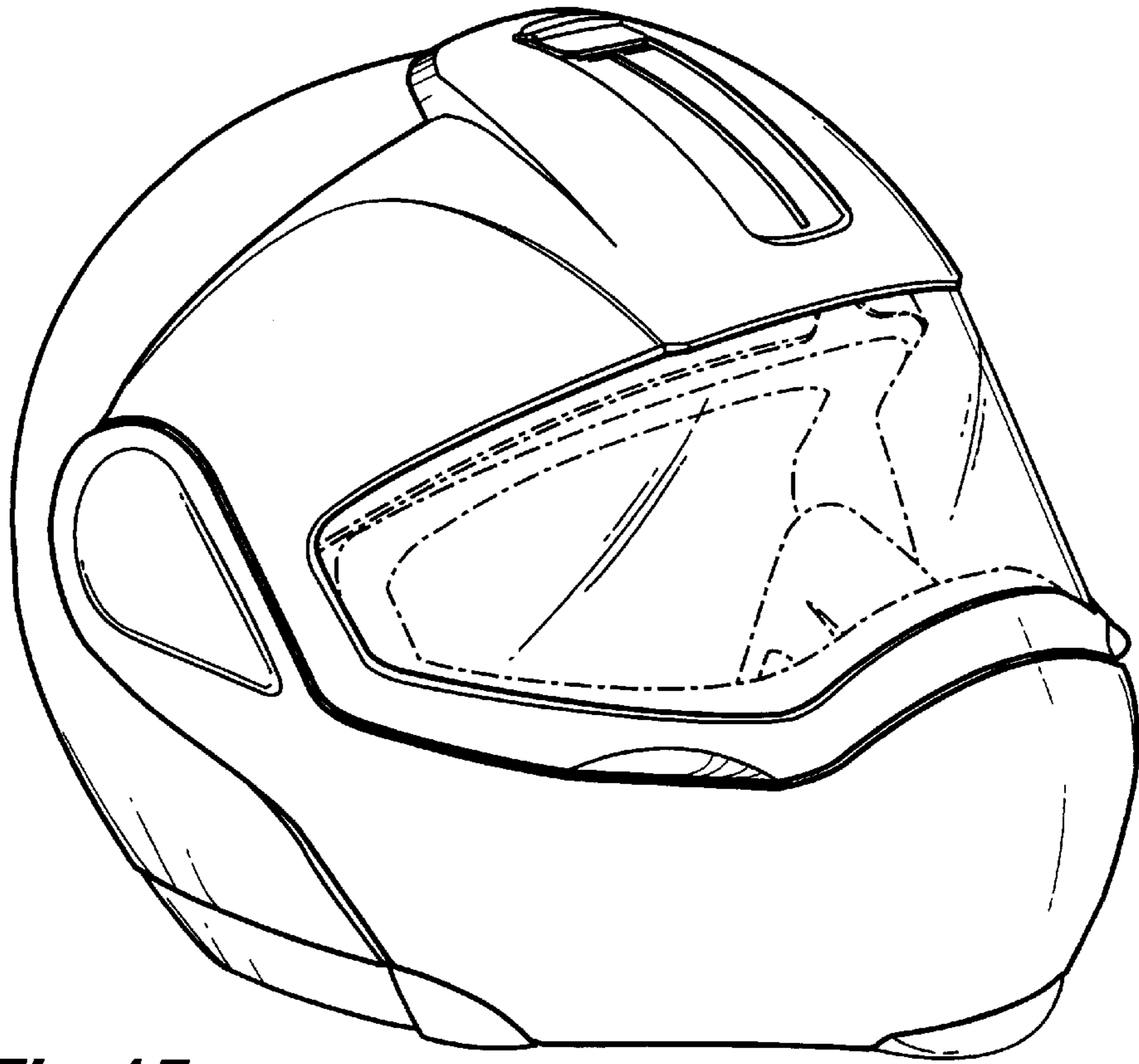

Fig.15

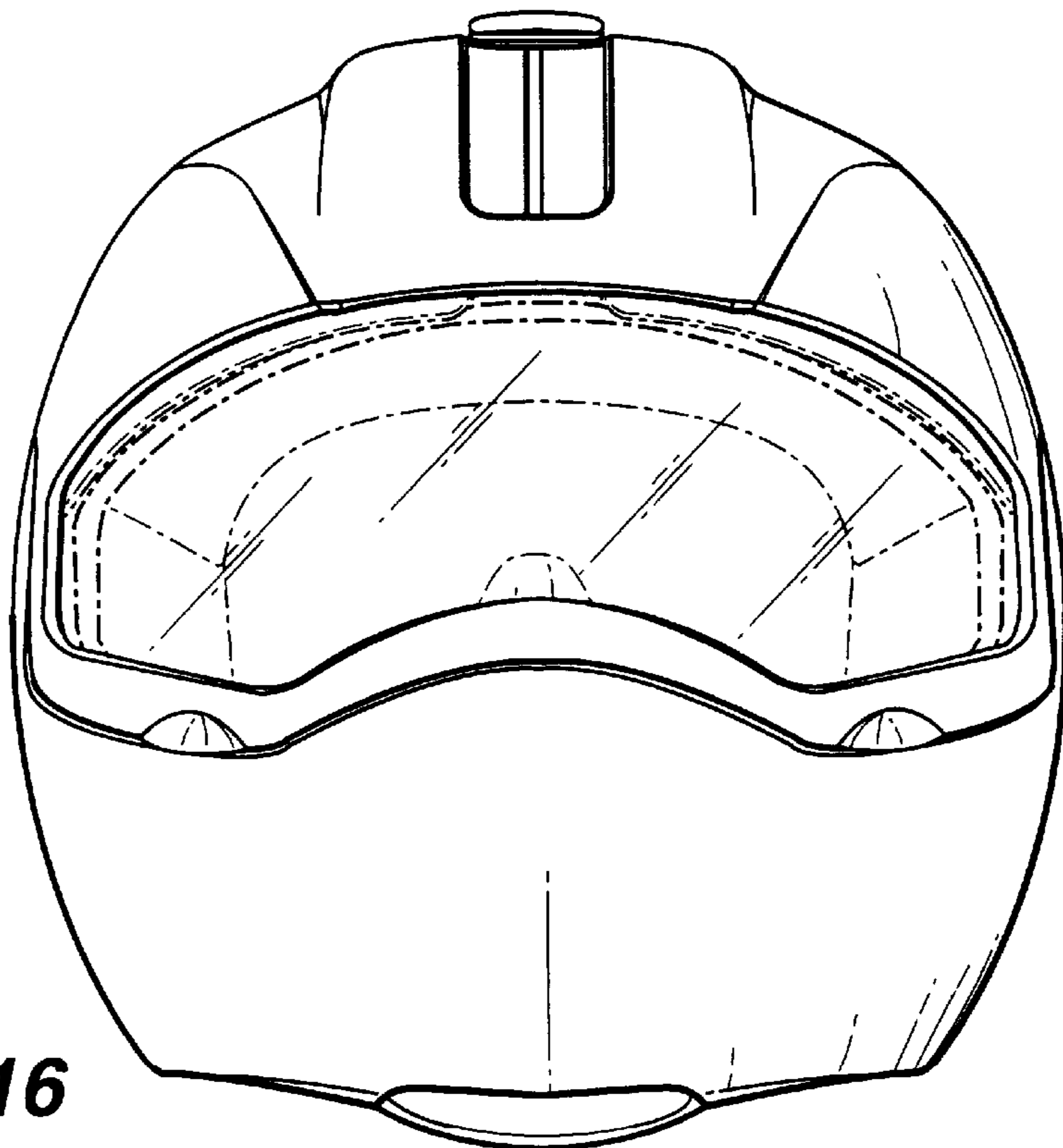

Fig.16

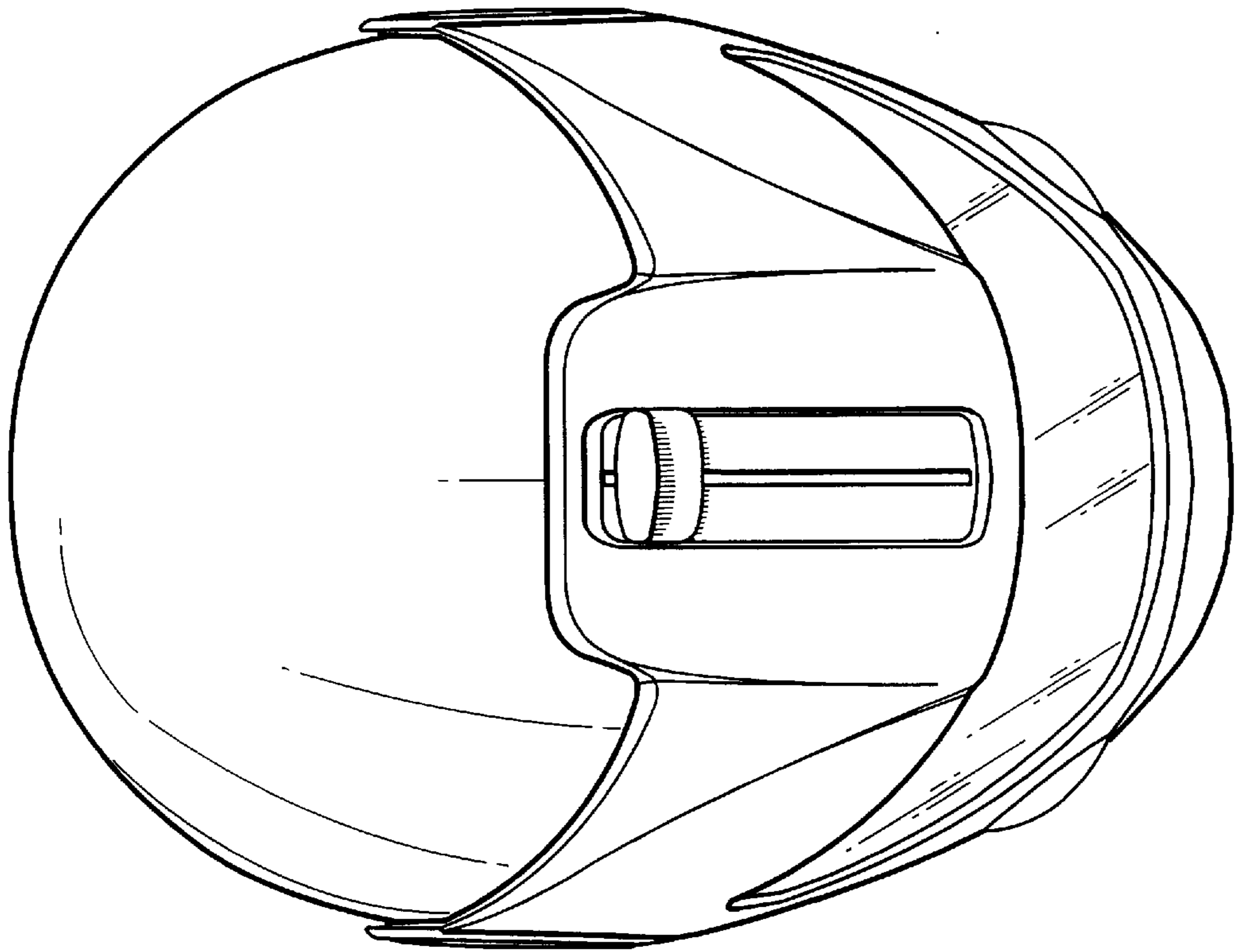

Fig.18

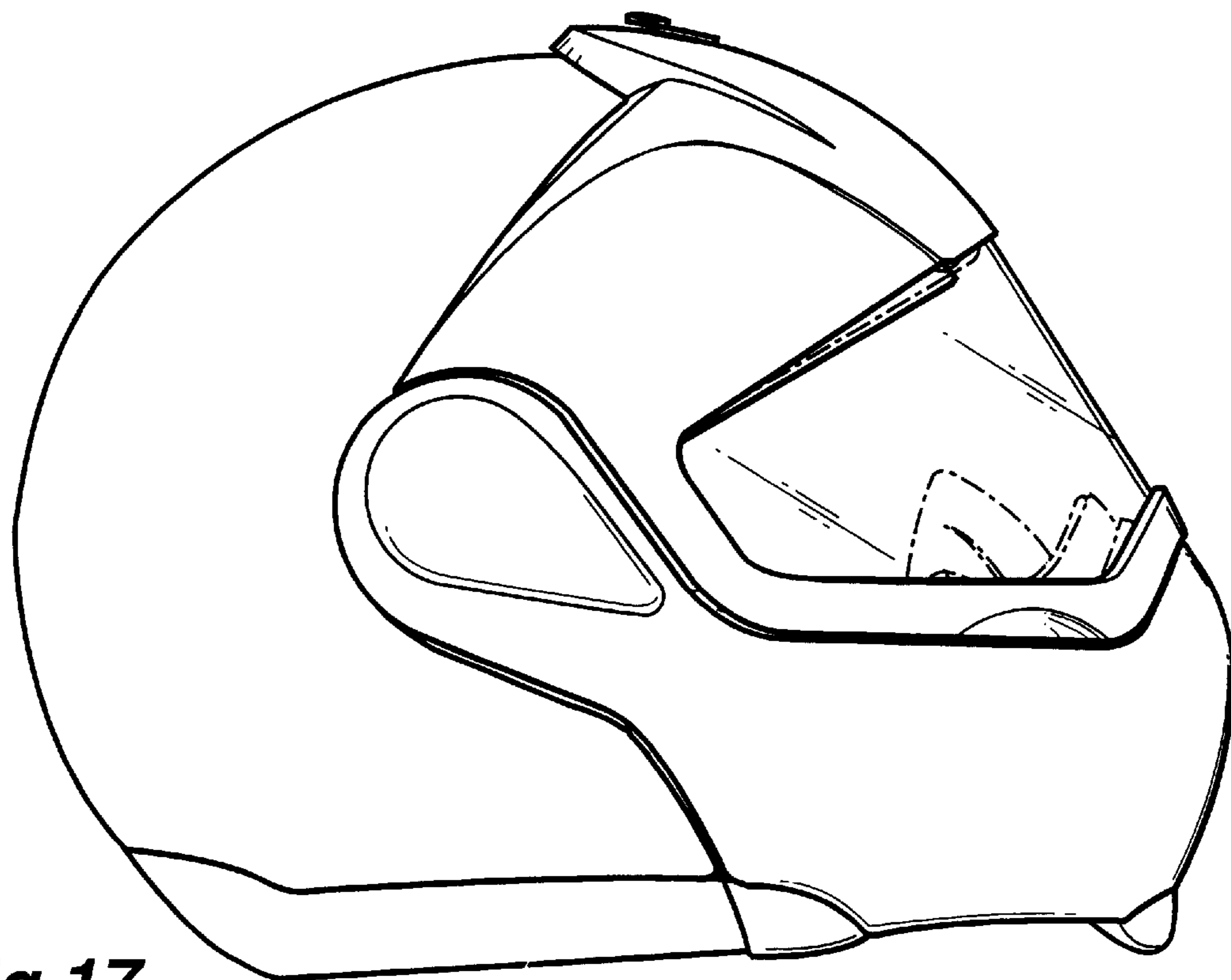

Fig.17

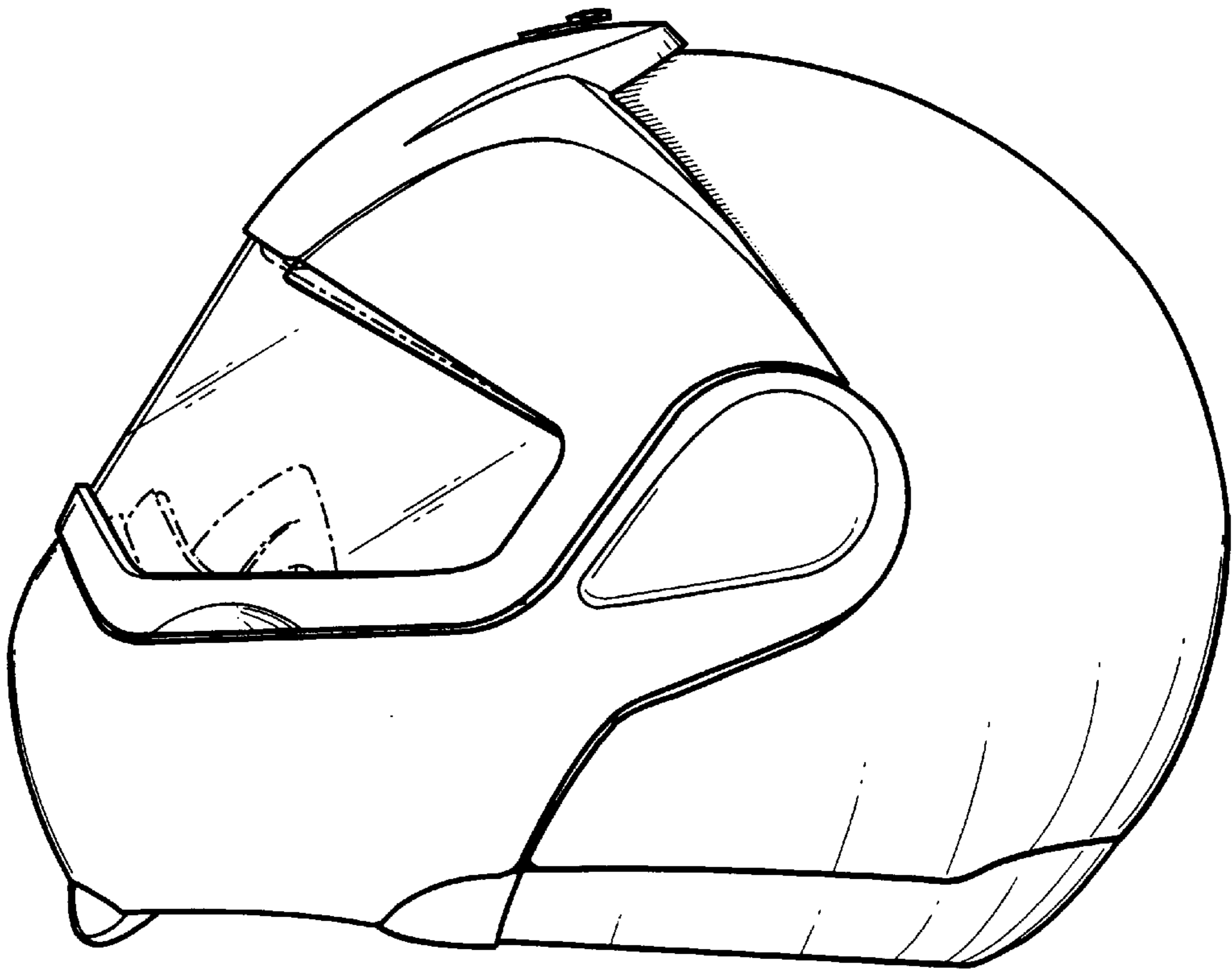

Fig.19

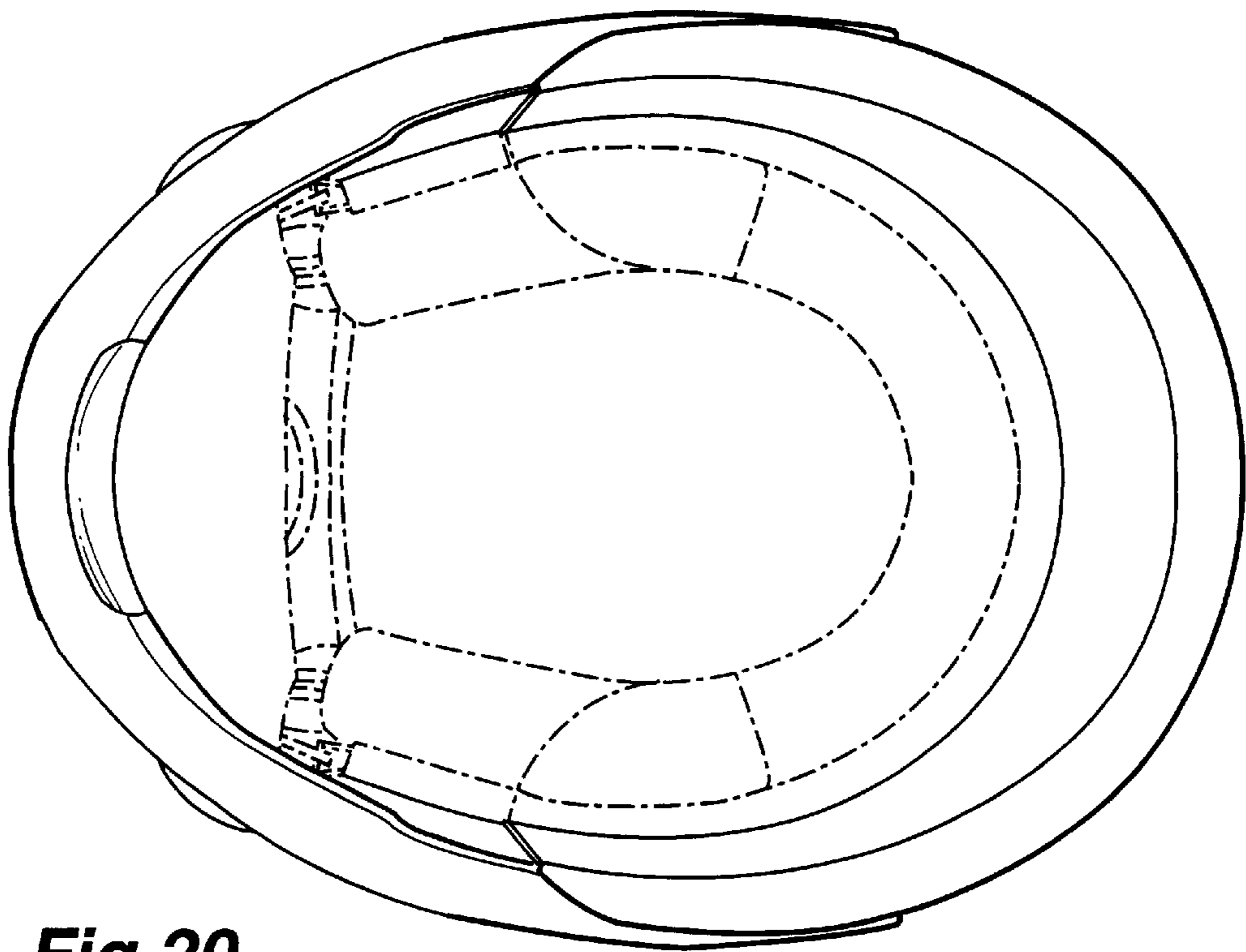

Fig.20

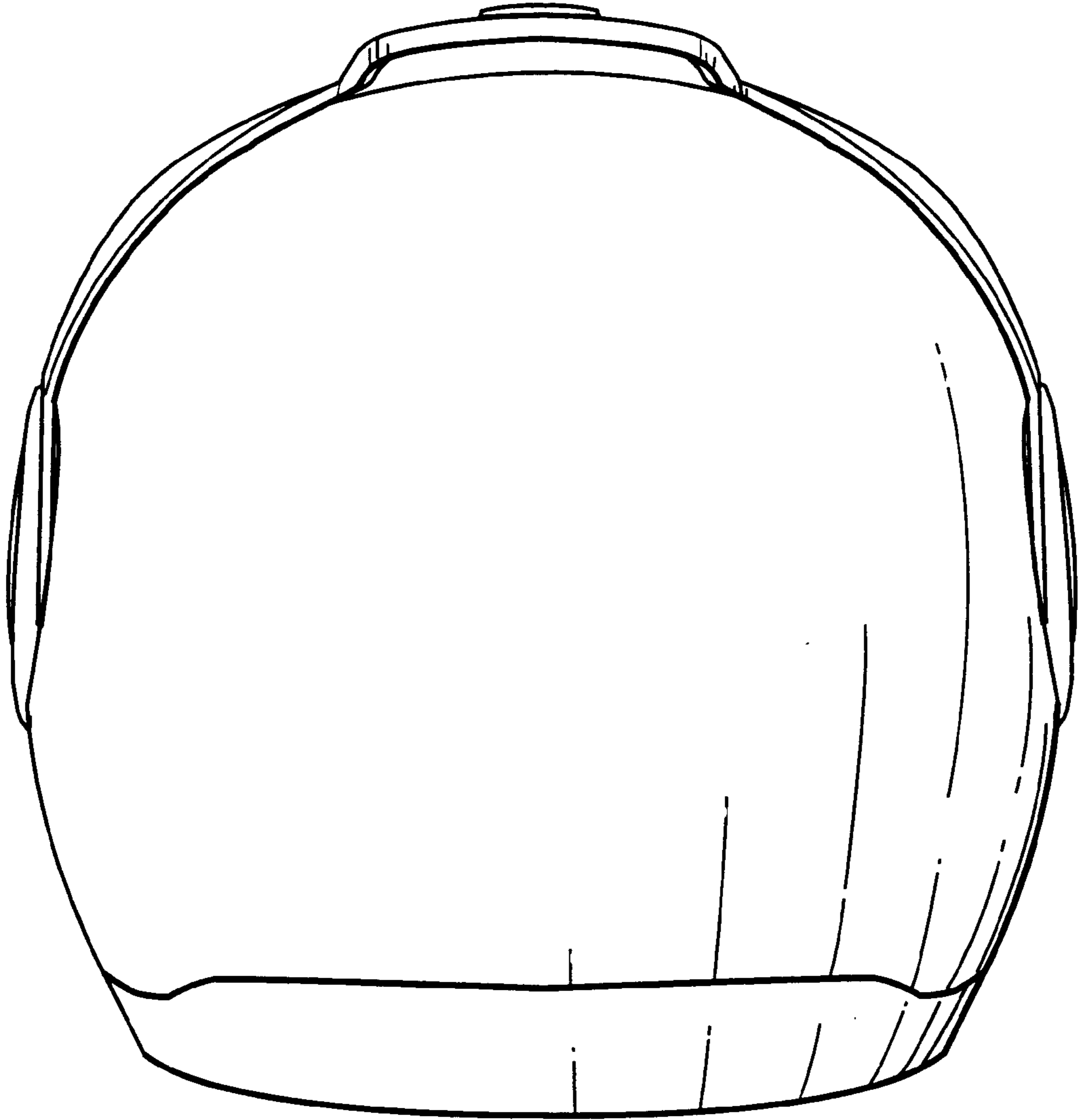

Fig.21