



US00D450055B1

(12) **United States Design Patent**
Yang

(10) **Patent No.:** **US D450,055 S**

(45) **Date of Patent:** **** Nov. 6, 2001**

(54) **EXTRACTABLE PANEL OF A HARD DISK DRIVE**

D. 408,386 * 4/1999 Yeh et al. D14/445
D. 415,140 * 10/1999 Waaler D14/441

(75) Inventor: **Chung-Da Yang, Ta Li (TW)**

* cited by examiner

(73) Assignee: **Lite-On Enclosure Inc., Taipei (TW)**

Primary Examiner—Freda Nunn

(**) Term: **14 Years**

(74) *Attorney, Agent, or Firm*—Rosenberg, Klein & Lee

(21) Appl. No.: **29/133,792**

(57) **CLAIM**

(22) Filed: **Dec. 8, 2000**

The ornamental design for an extractable panel of a hard disk drive, as shown and described.

(51) **LOC (7) Cl.** **14-02**

DESCRIPTION

(52) **U.S. Cl.** **D14/444**

FIG. 1 is the perspective view of an extractable panel of a hard disk drive showing my new design;

(58) **Field of Search** D14/441-446;
D13/162, 184, 199, 164, 177; 312/223.2;
361/680-686

FIG. 2 is the front view thereof;

FIG. 3 is the rear view thereof;

FIG. 4 is the left side view thereof;

FIG. 5 is the right side view thereof;

FIG. 6 is the top view thereof; and,

FIG. 7 is the bottom view thereof.

(56) **References Cited**

U.S. PATENT DOCUMENTS

D. 307,423 * 4/1990 Hill D14/441

1 Claim, 4 Drawing Sheets

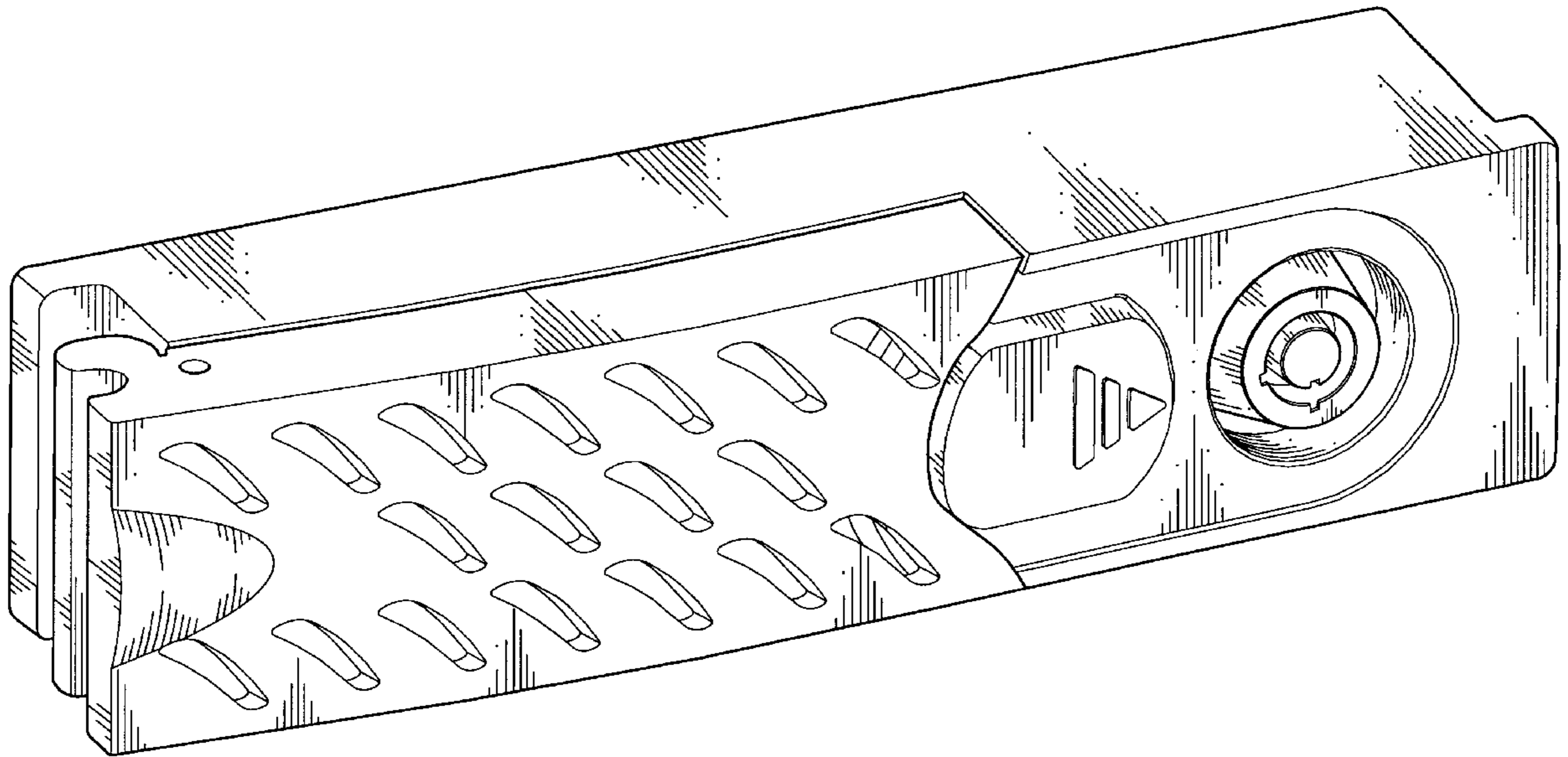

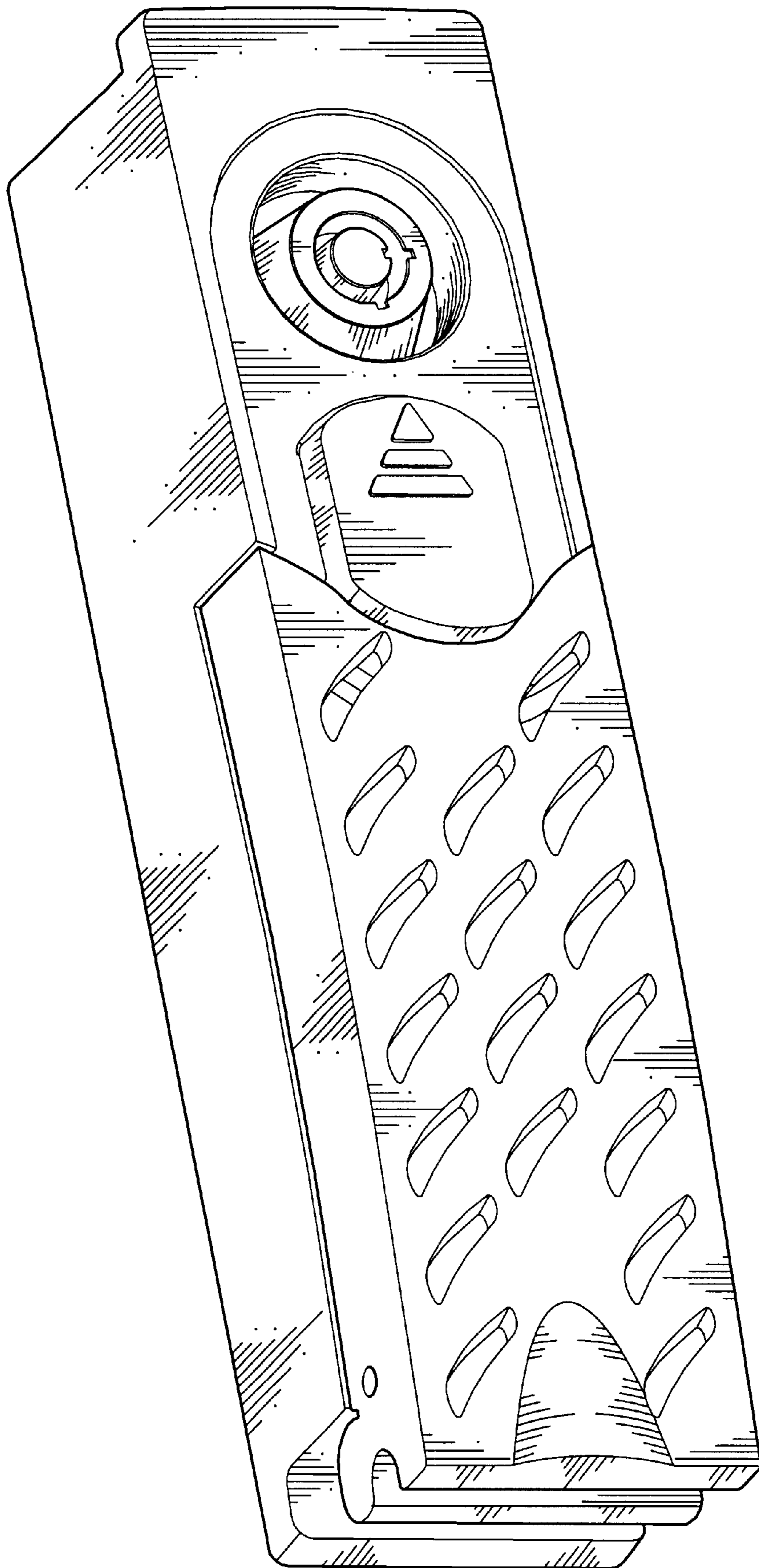

FIG. 1

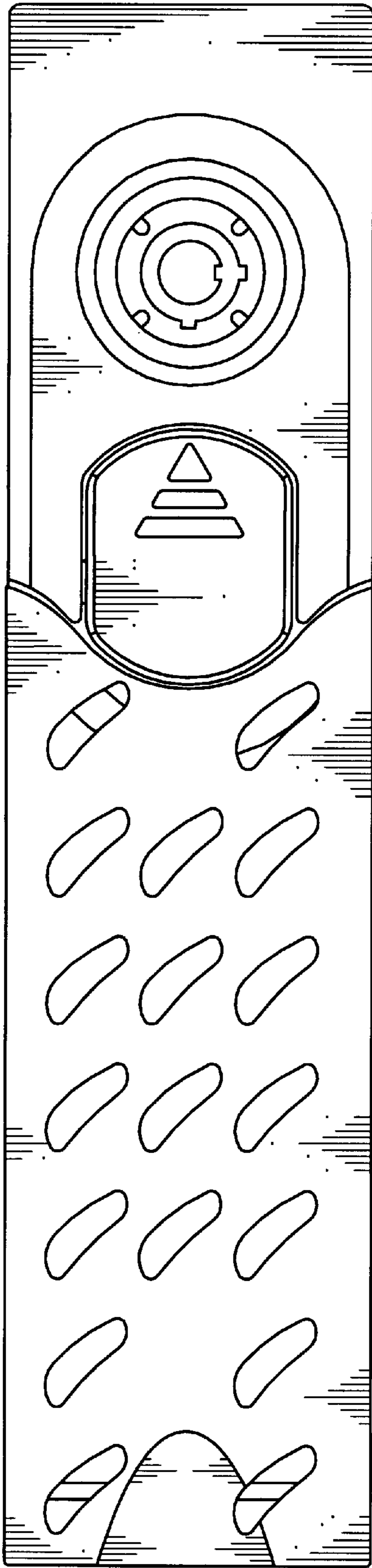

FIG. 2

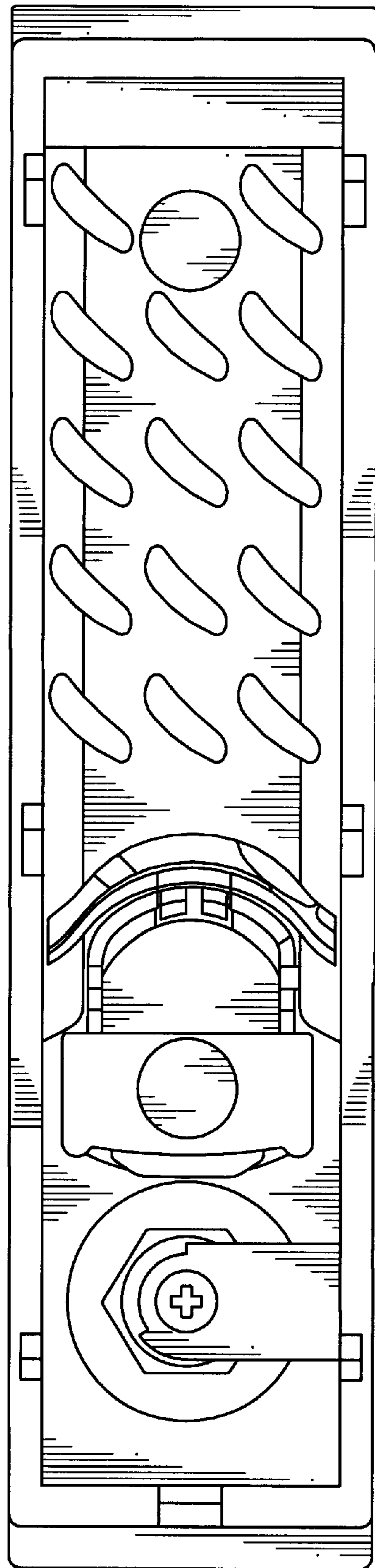

FIG. 3

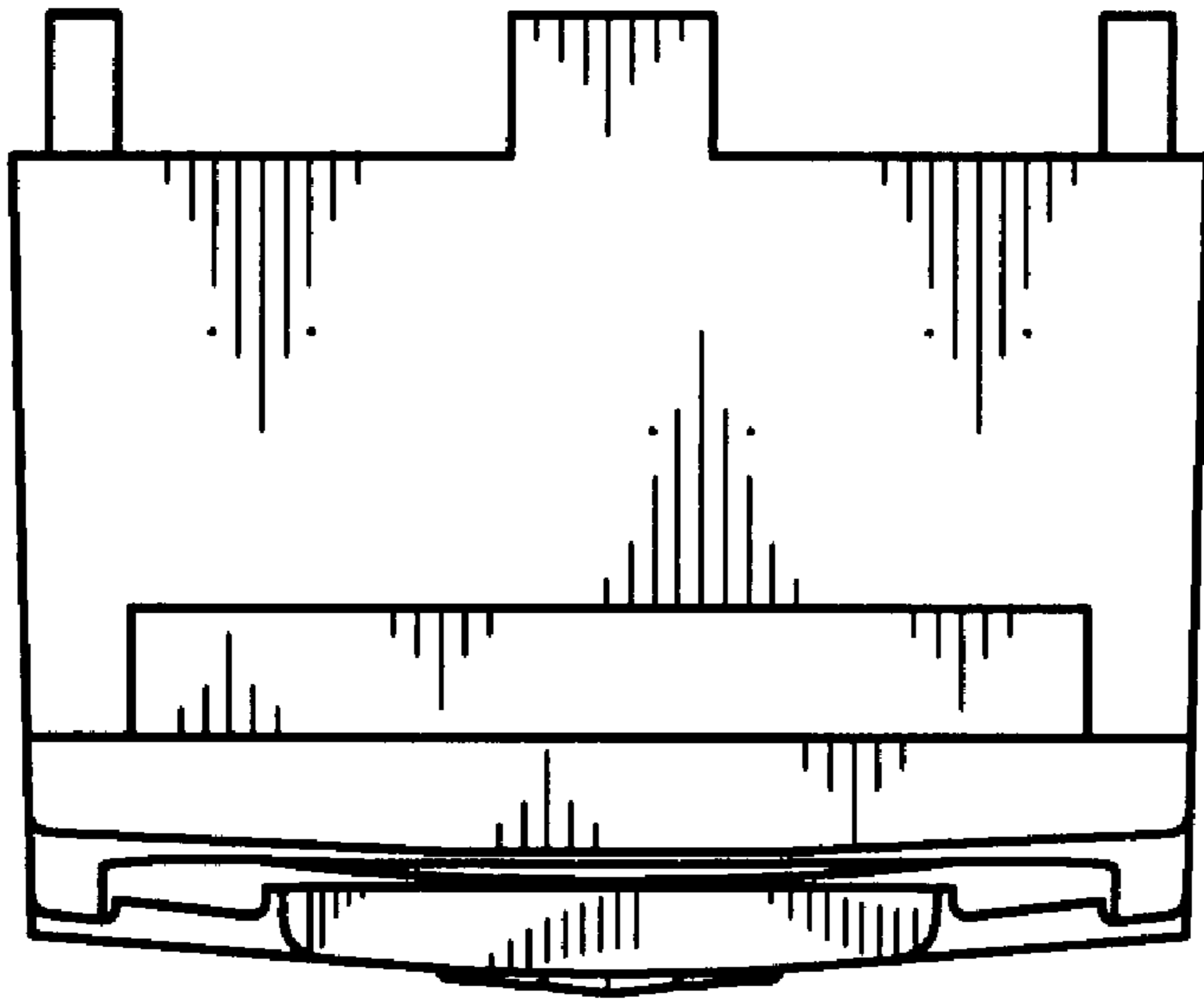

FIG. 4

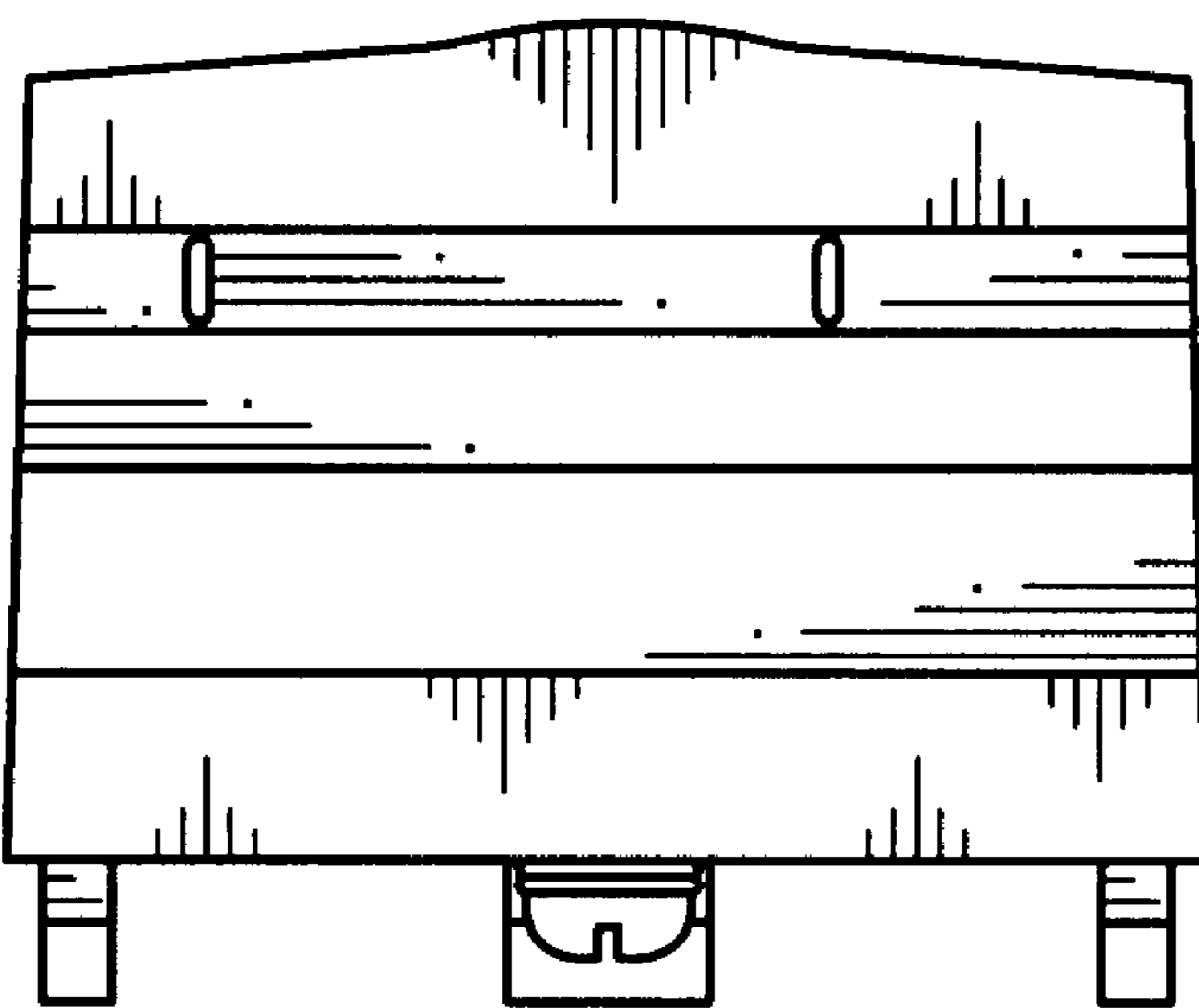

FIG. 5

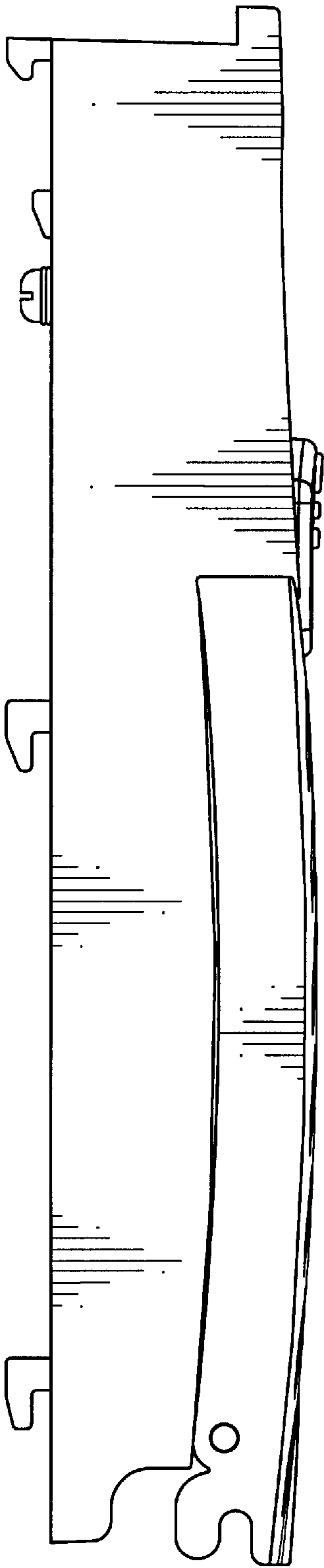

FIG. 6

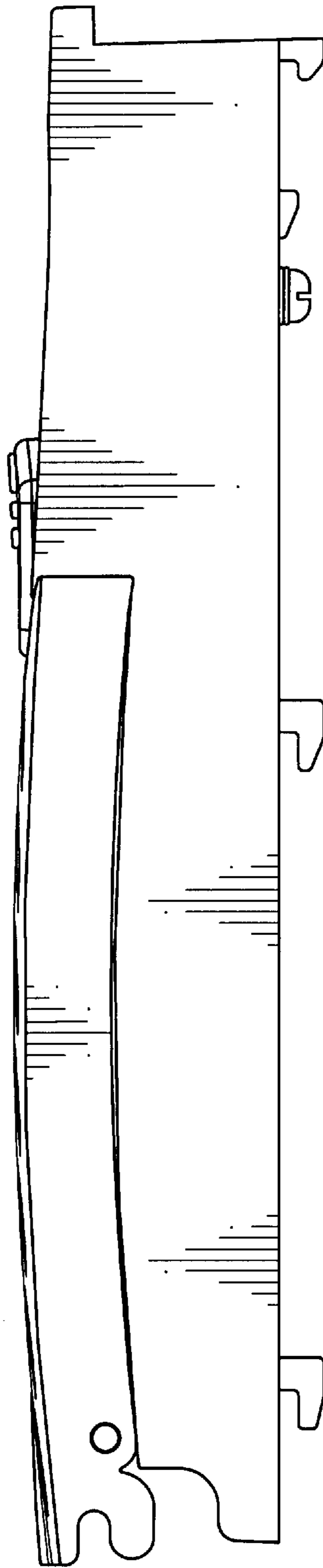

FIG. 7