



US00D449951B1

(12) **United States Design Patent**
Schmidt et al.

(10) **Patent No.:** **US D449,951 S**

(45) **Date of Patent:** **** Nov. 6, 2001**

(54) **PLUNGER CADDY**

(75) Inventors: **William F. Schmidt**, Libertyville;
Michael S. Murphy, Wilmette, both of
IL (US); **Mark A. Mrocca**, Belleville,
MI (US)

(73) Assignee: **The Faucet-Queens, Inc.**, Vernon Hills,
IL (US)

(**) Term: **14 Years**

(21) Appl. No.: **29/143,248**

(22) Filed: **Jun. 8, 2001**

(51) **LOC (7) Cl.** **23-02**

(52) **U.S. Cl.** **D6/524; D6/551**

(58) **Field of Search** **D6/524, 551; 206/207,**
206/209, 209.1, 349, 361, 362.2, 362.3,
15.2, 15.3; 312/206

4,008,933	2/1977	Wanek .	
4,458,368	7/1984	Webb .	
4,768,237	9/1988	Torti .	
4,831,669	5/1989	Edwards .	
5,456,356 *	10/1995	Kurzawa	206/349
5,836,322	11/1998	Borger et al. .	
5,924,566	7/1999	Gibbs .	
5,958,150	9/1999	Borger et al. .	
5,971,141	10/1999	Shafik .	
6,035,456	3/2000	Taylor .	
6,038,709	3/2000	Kent .	
6,241,091 *	6/2001	Moore et al.	206/349

* cited by examiner

Primary Examiner—Brian N. Vinson

(74) *Attorney, Agent, or Firm*—Kwadjo Andusei-Poku;
Lloyd D. Doigan

(57) **CLAIM**

The ornamental design for a plunger caddy, as shown and described.

(56) **References Cited**

U.S. PATENT DOCUMENTS

D. 276,291 *	11/1984	Boroch	D6/551 X
D. 291,039 *	7/1987	Bokmiller	D6/551
D. 298,712 *	11/1988	Mattei	D6/551
D. 315,269 *	3/1991	Brazis	D6/551
D. 362,575 *	9/1995	Bird et al.	D6/551
D. 383,935 *	9/1997	Zawalsky	D6/524
D. 400,748 *	11/1998	France	D6/551
D. 413,470 *	9/1999	Burton	D6/551
2,757,787 *	8/1956	Sergent	206/361
3,085,678 *	4/1963	Moore	206/361 X

DESCRIPTION

FIG. 1 is a top perspective view of a plunger caddy showing our new design;
FIG. 2 is a left side elevational view thereof;
FIG. 3 is a right side elevational view thereof;
FIG. 4 is a front elevational view thereof;
FIG. 5 is a rear elevational view thereof;
FIG. 6 is a top plan view thereof; and,
FIG. 7 is a bottom plan view thereof.

1 Claim, 2 Drawing Sheets

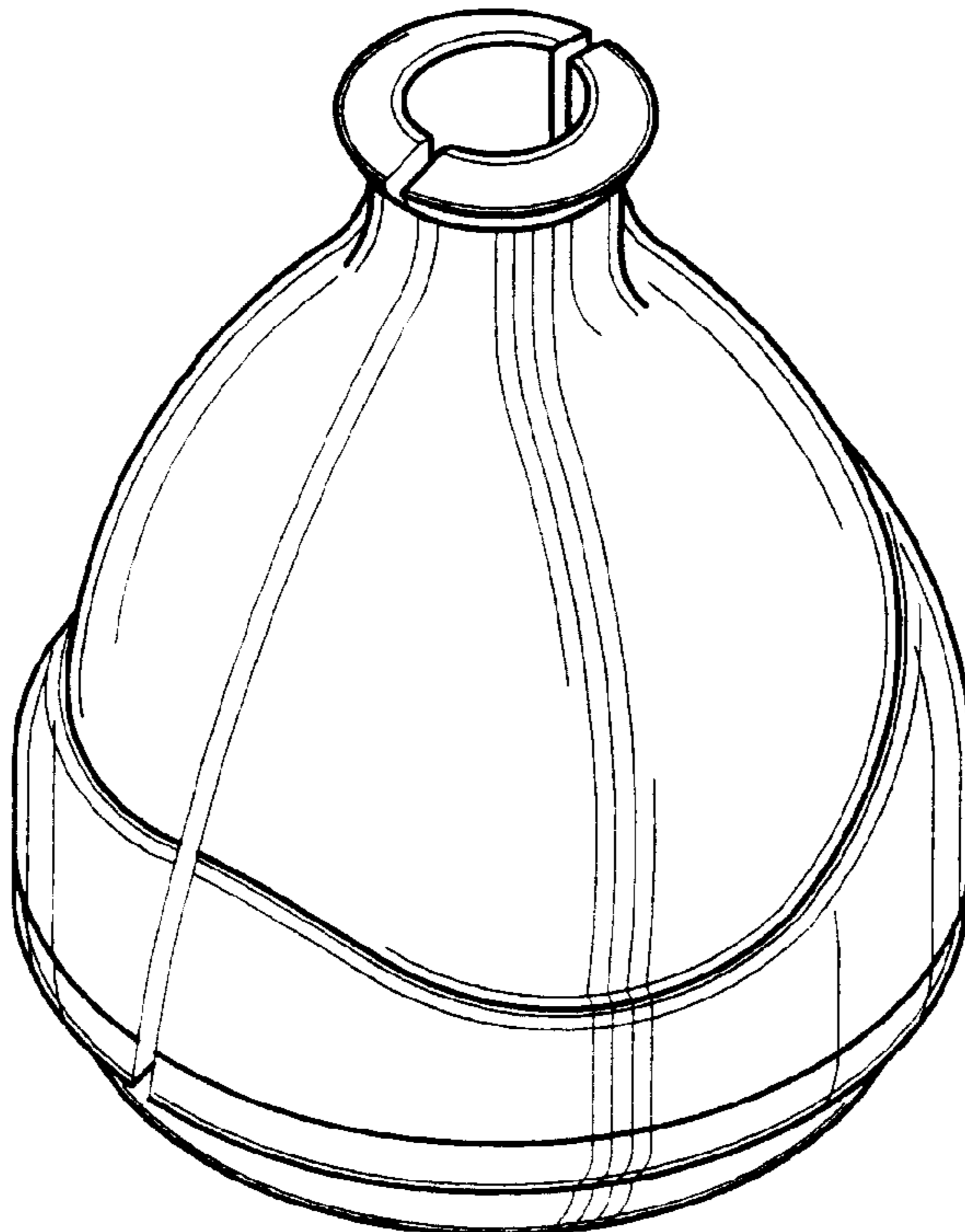

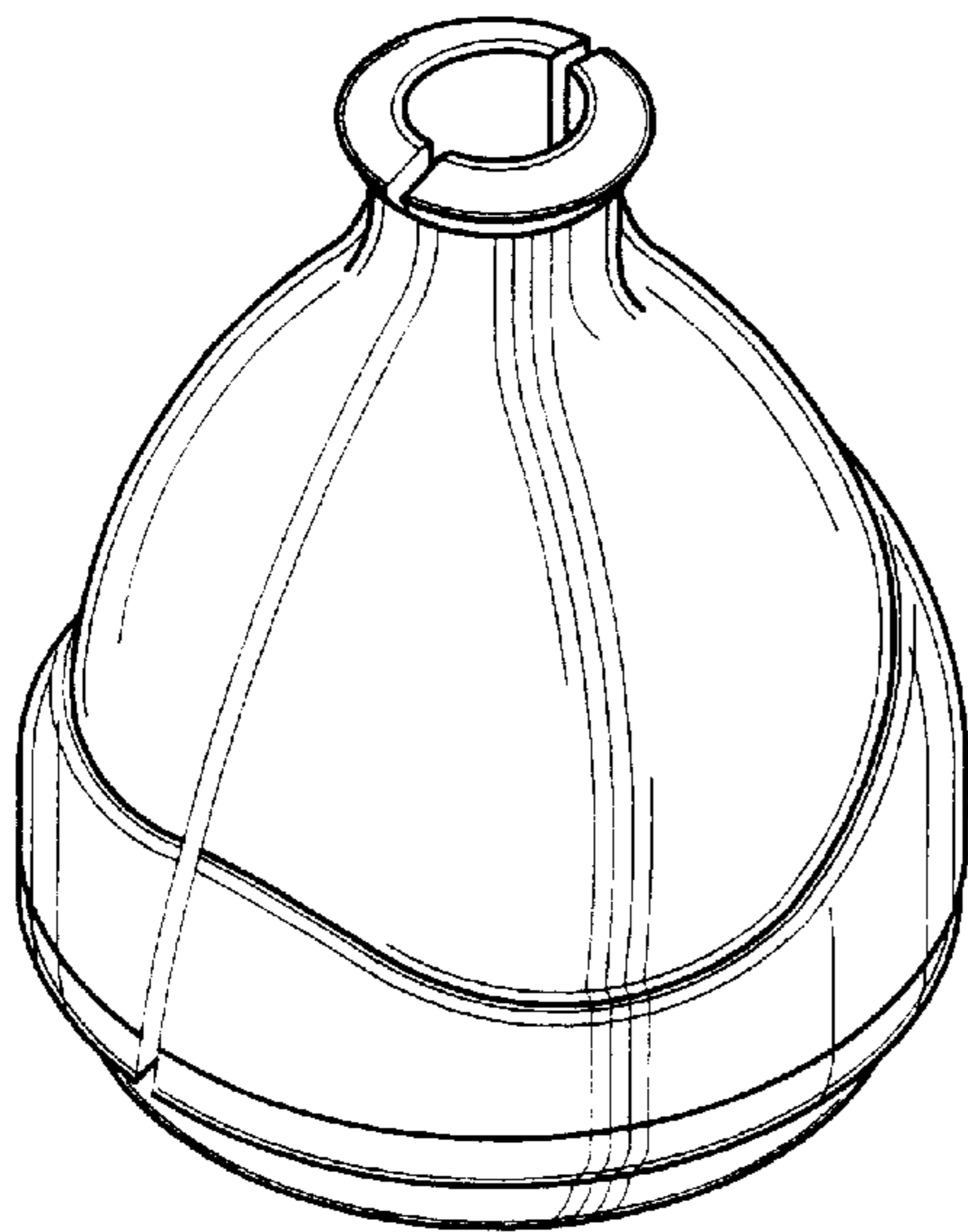

Fig-1

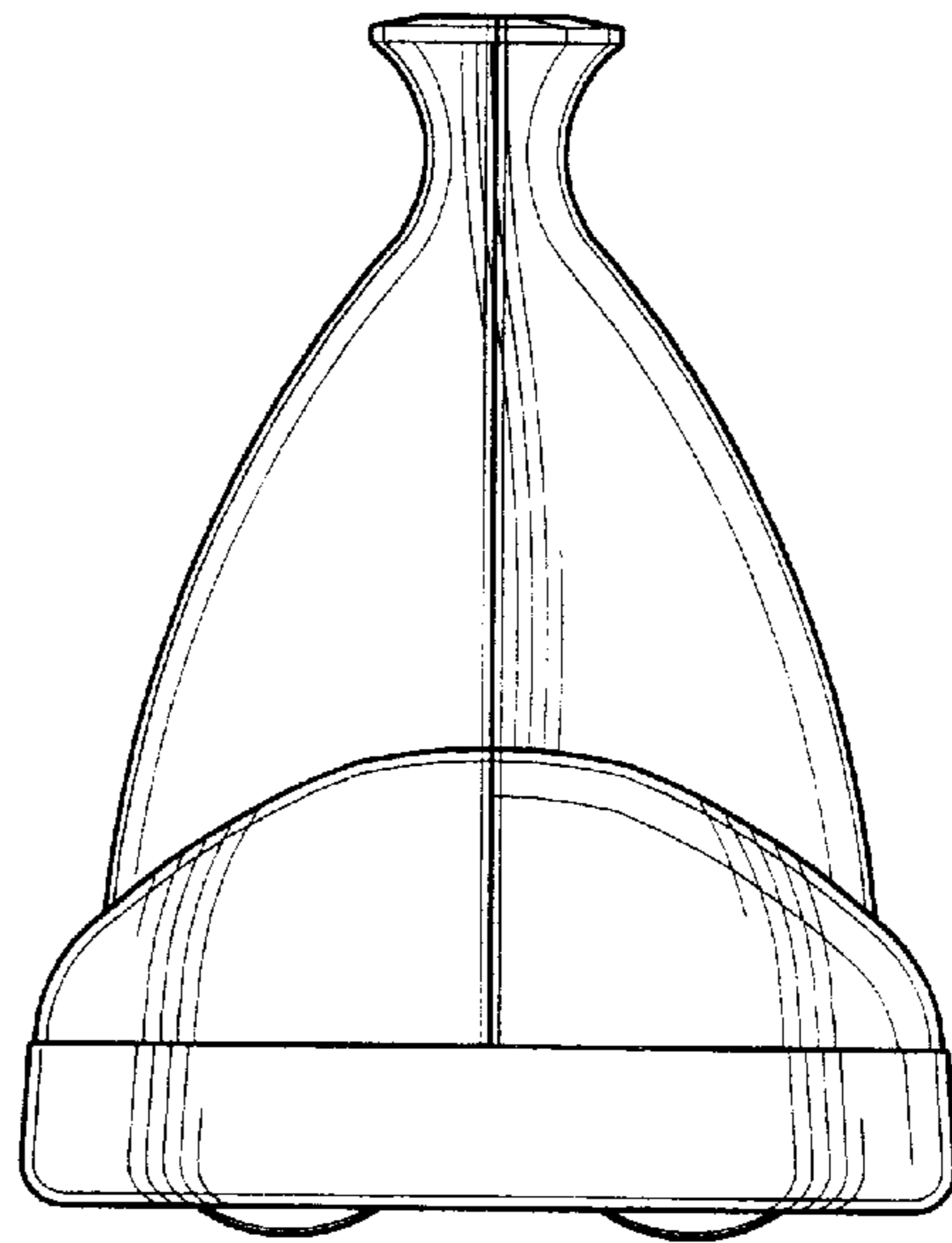

Fig-2

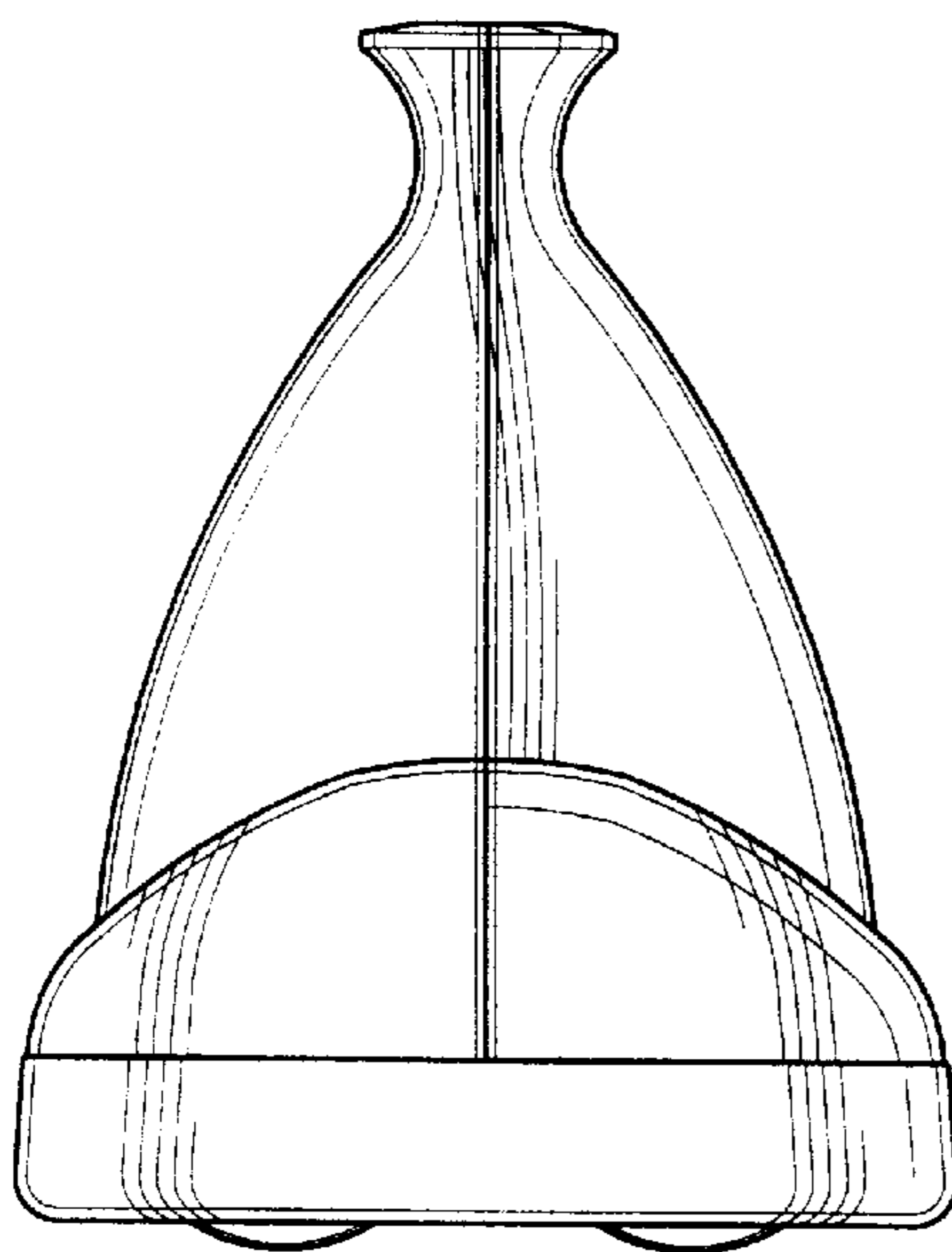

Fig-3

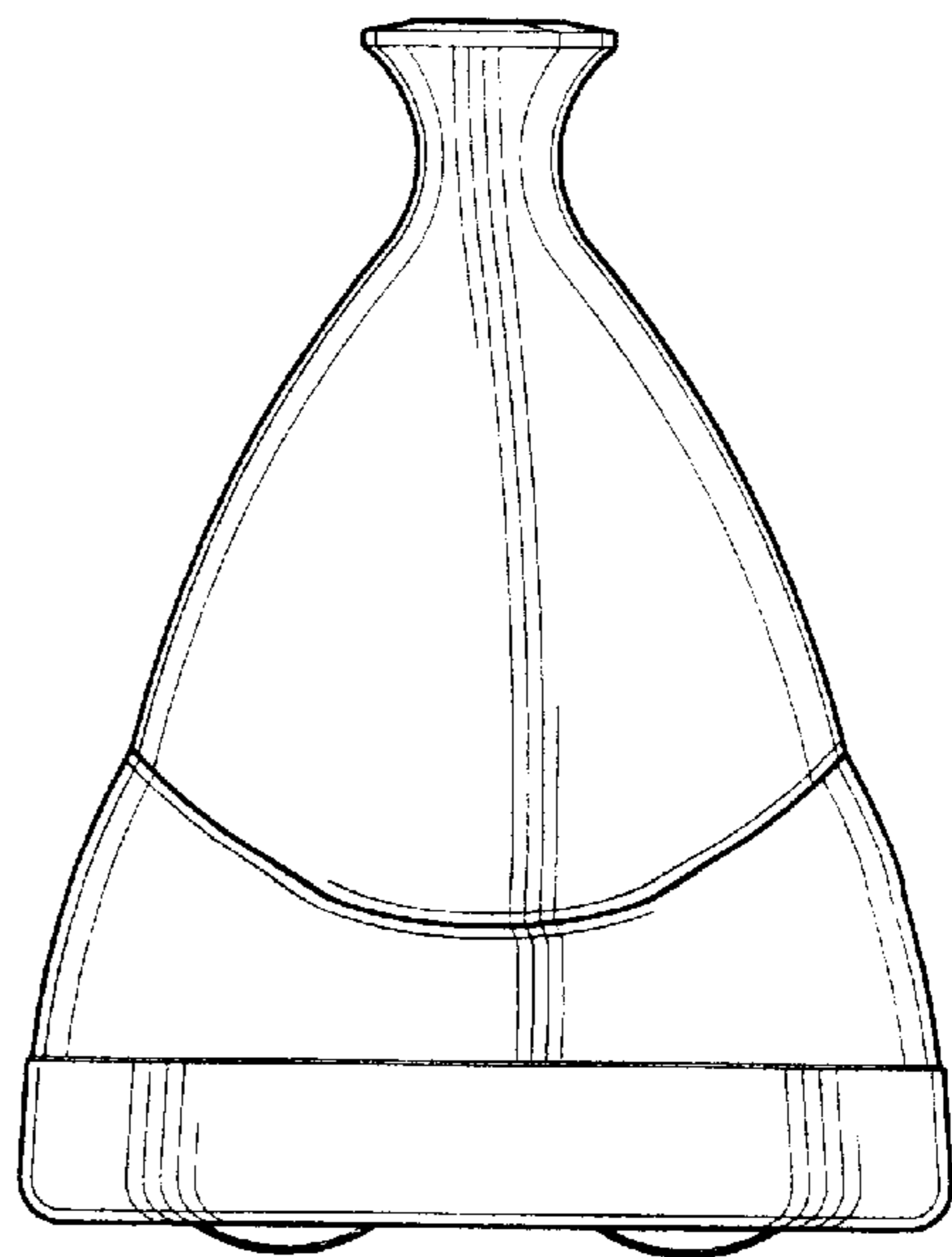

Fig-4

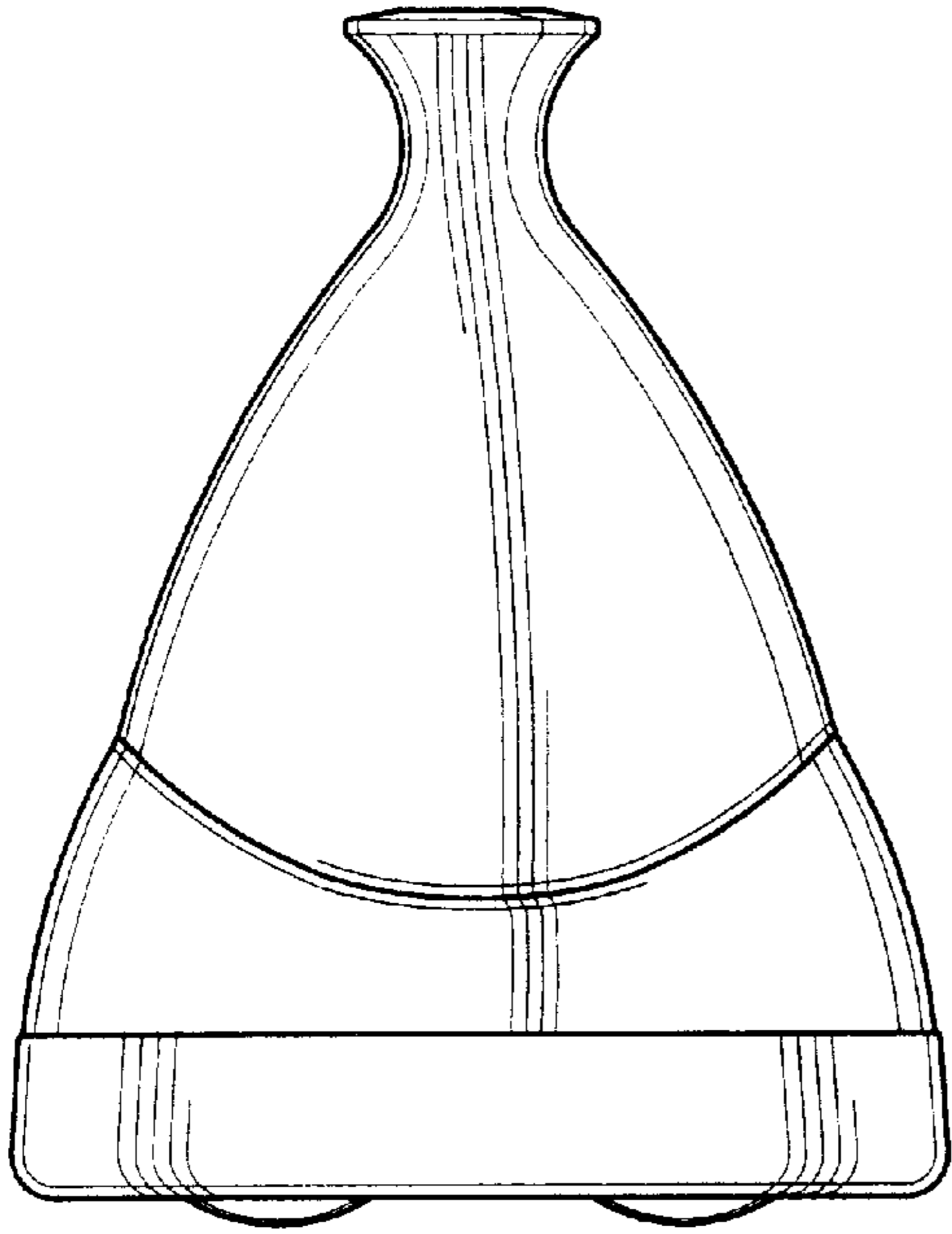

Fig-5

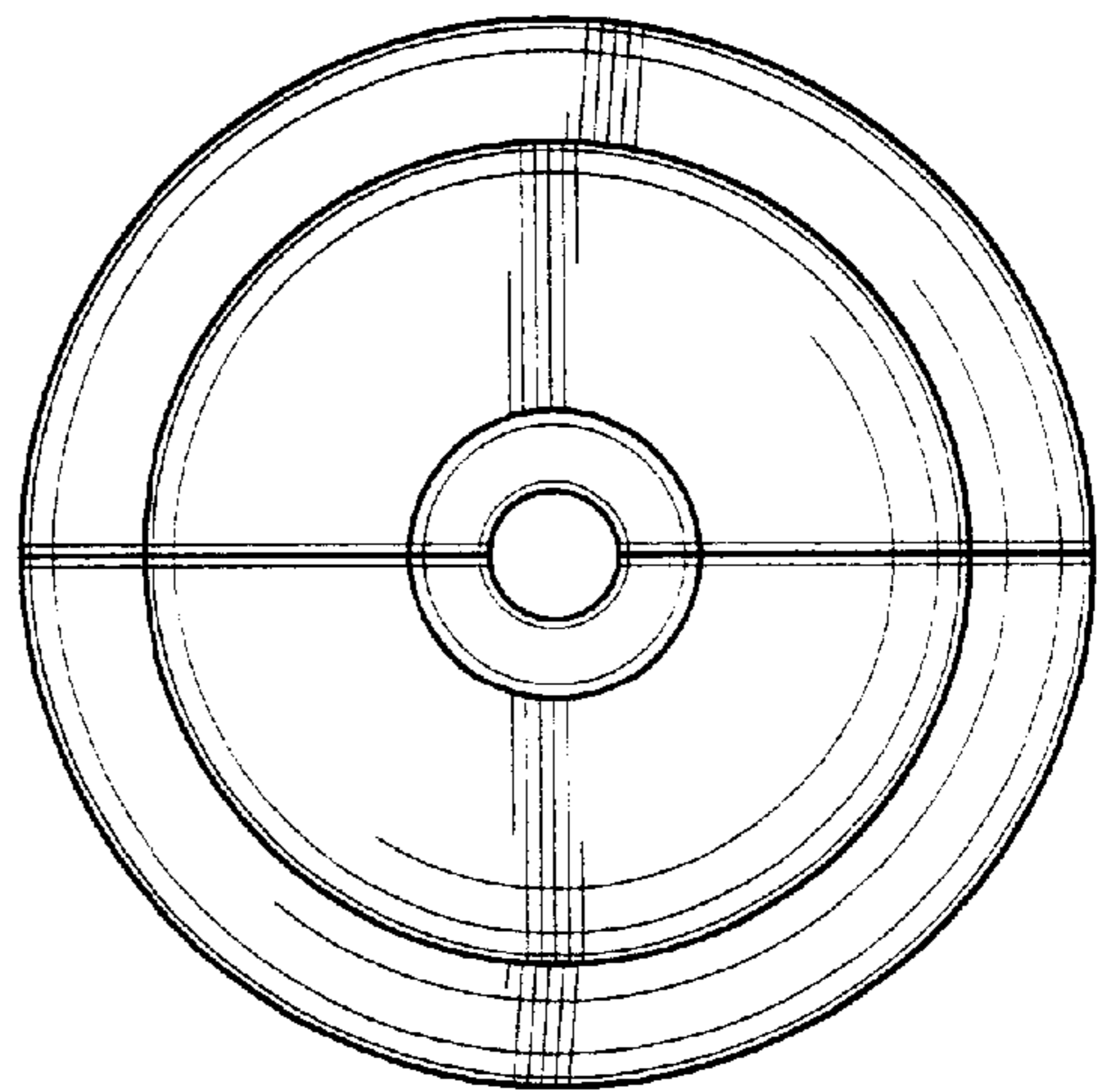

Fig-6

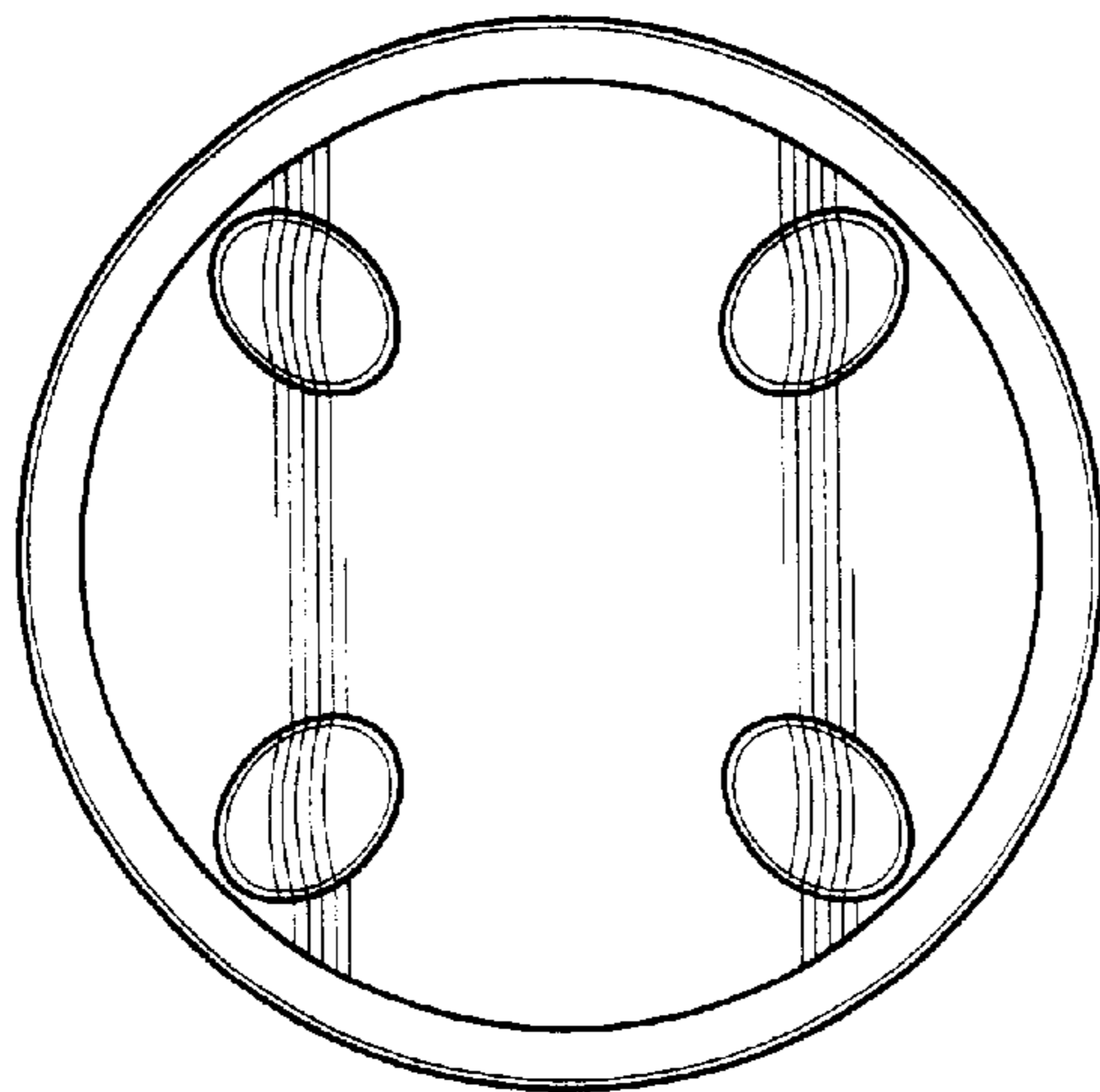

Fig-7