



US00D449947B1

(12) **United States Design Patent**
Schoefer

(10) **Patent No.:** **US D449,947 S**

(45) **Date of Patent:** **** Nov. 6, 2001**

(54) **PORTABLE FOLDING SEAT**

(76) Inventor: **Lowanna Schoefer**, 22411 Peacock La.,
Anderson, CA (US) 96007

(**) Term: **14 Years**

(21) Appl. No.: **29/080,055**

(22) Filed: **Nov. 26, 1997**

(51) **LOC (7) Cl.** **06-06**

(52) **U.S. Cl.** **D6/500; D6/368**

(58) **Field of Search** D6/334, 335, 336,
D6/368, 374, 500, 501, 502; 297/183.5,
350, 352, 380, 382

(56) **References Cited**

U.S. PATENT DOCUMENTS

D. 254,582	*	4/1980	de Santis	D6/368
D. 329,145	*	9/1992	Hwang et al.	D6/368
D. 360,308	*	7/1995	Smith et al.	D6/368 X
D. 360,768	*	8/1995	Hwang et al.	D6/368
2,001,252	*	5/1935	Johnson	D6/368 X
2,180,426	*	11/1939	Milligan	297/380 X
3,825,298	*	7/1974	Chipman	297/380 X
4,824,171	*	4/1989	Hollingsworth	297/380 X
5,100,203	*	3/1992	Novak	297/382
5,190,350	*	3/1993	Hwang et al.	297/380
5,384,923	*	1/1995	Hwang et al.	297/380 X
5,385,390	*	1/1995	Freeman et al.	297/380

OTHER PUBLICATIONS

Backpacker magazine, p. 90, Crazy Creek seat at top left,
Apr. 1993.*

Cover and p. 139 from Apr. 1996 Backpacker Magazine.
Web page for <http://crazycreek.com/about.html>, Jun. 8,
1998.

* cited by examiner

Primary Examiner—Gary D. Watson

(74) *Attorney, Agent, or Firm*—Cislo & Thomas LLP

(57) **CLAIM**

The ornamental design for a portable folding seat, as shown
and described.

DESCRIPTION

FIG. 1 is a front perspective view of the portable folding seat
shown in open position;

FIG. 2 is a front perspective view as shown in FIG. 1, but
in closed position;

FIG. 3 is a back view thereof;

FIG. 4 is a bottom view thereof;

FIG. 5 is a right side view, which is symmetrical to a left side
view thereof;

FIG. 6 is a front side view thereof; and,

FIG. 7 is a top view thereof.

1 Claim, 4 Drawing Sheets

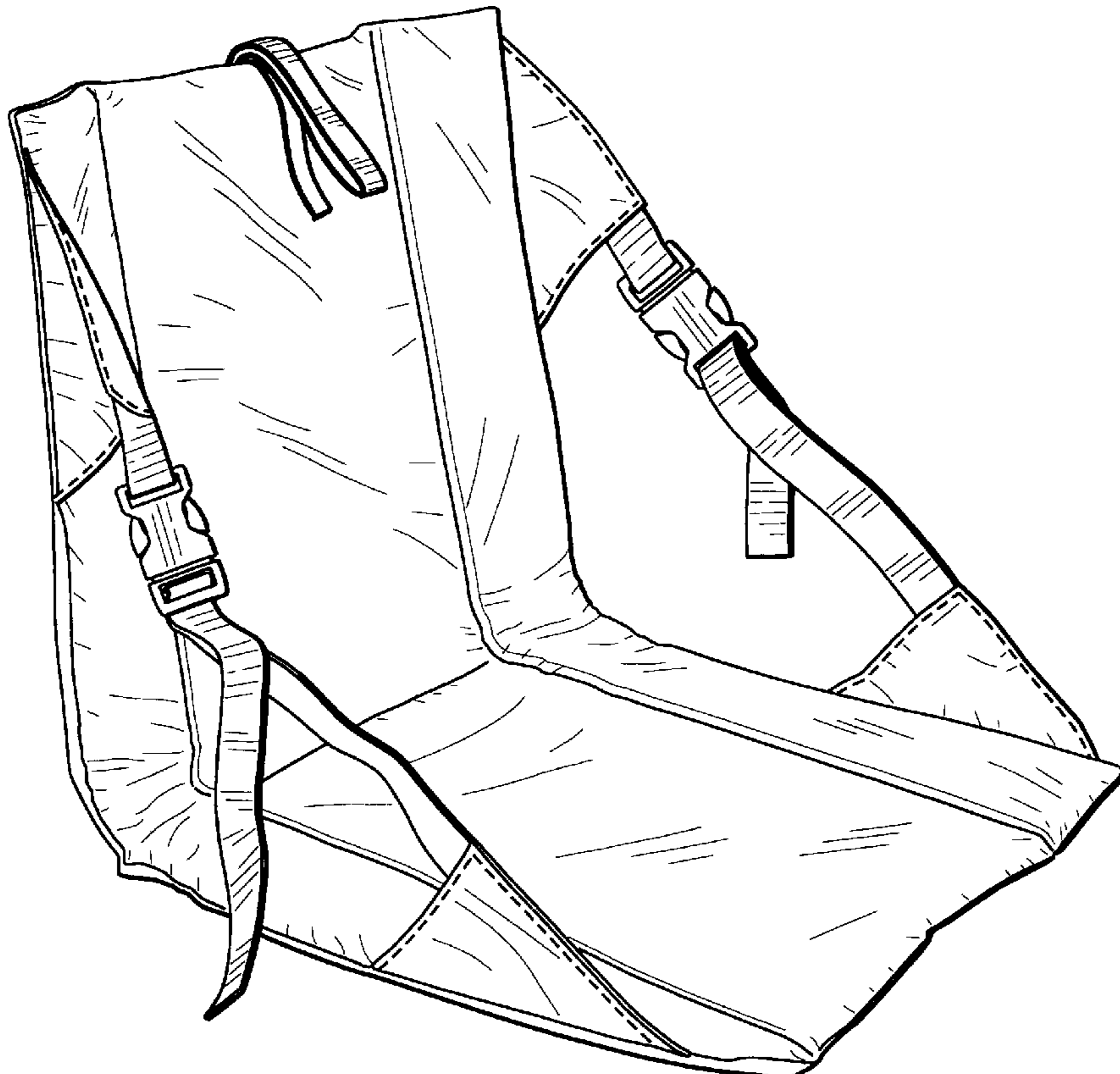

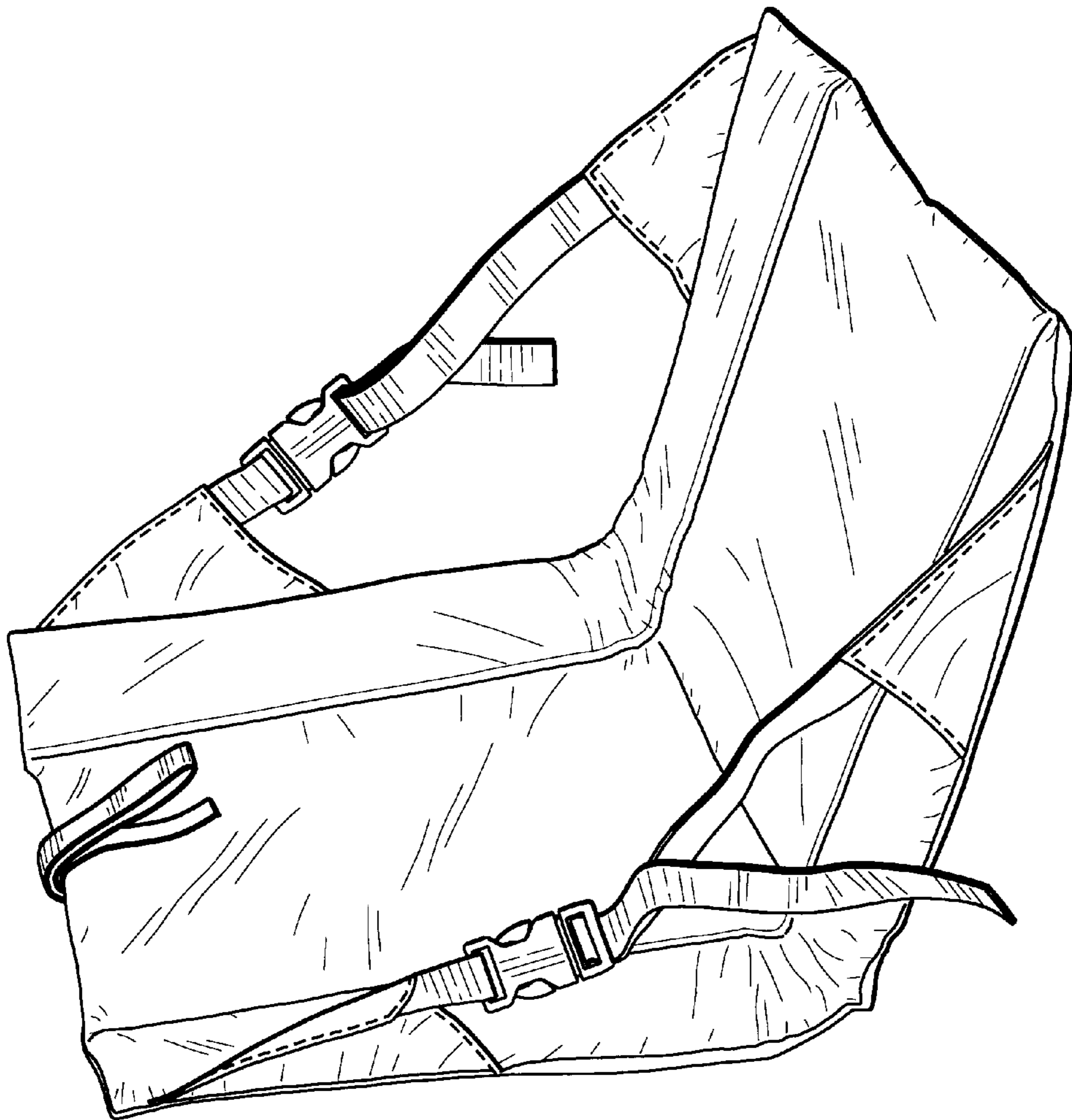

Fig. 1

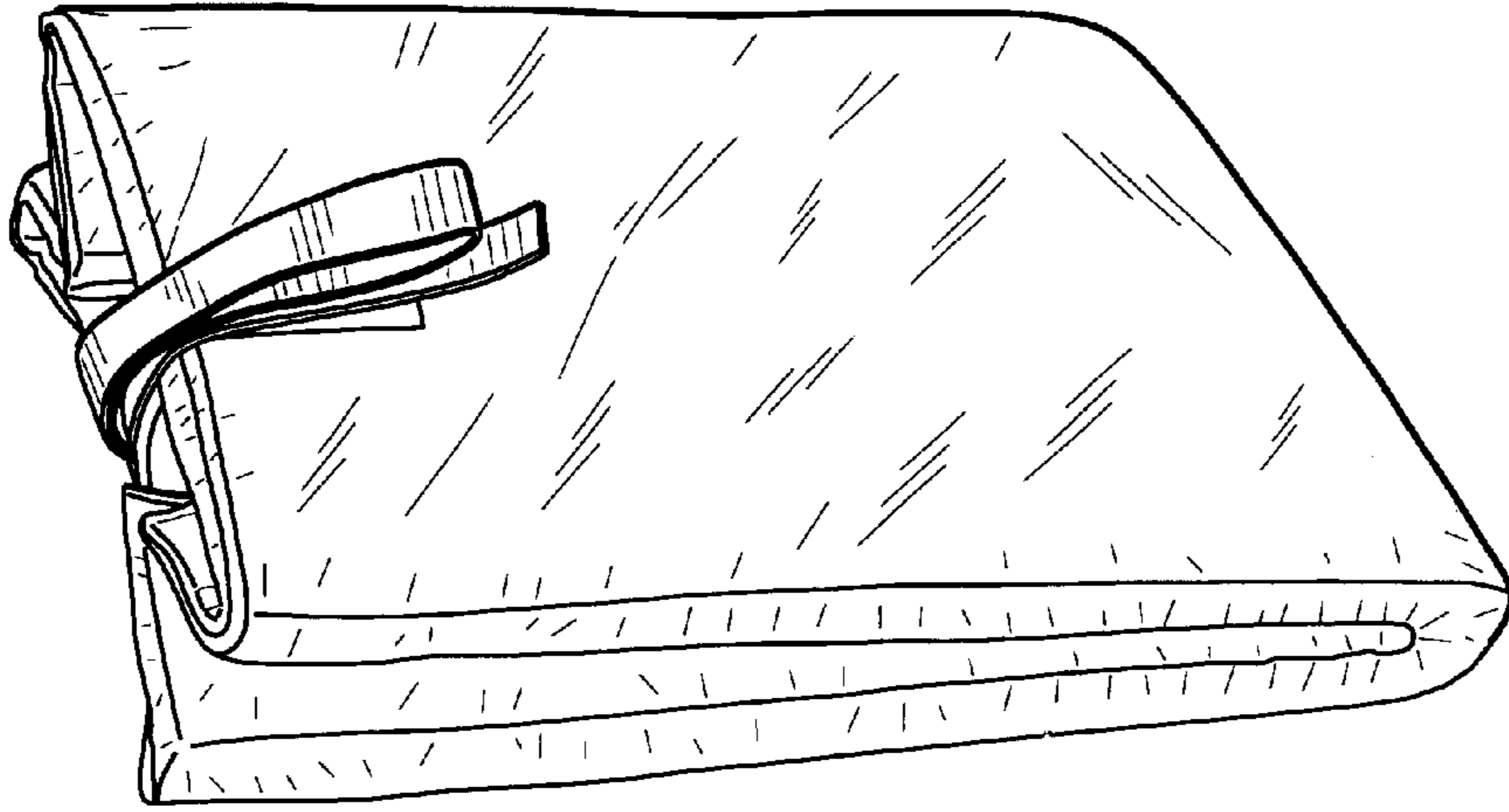

Fig. 2

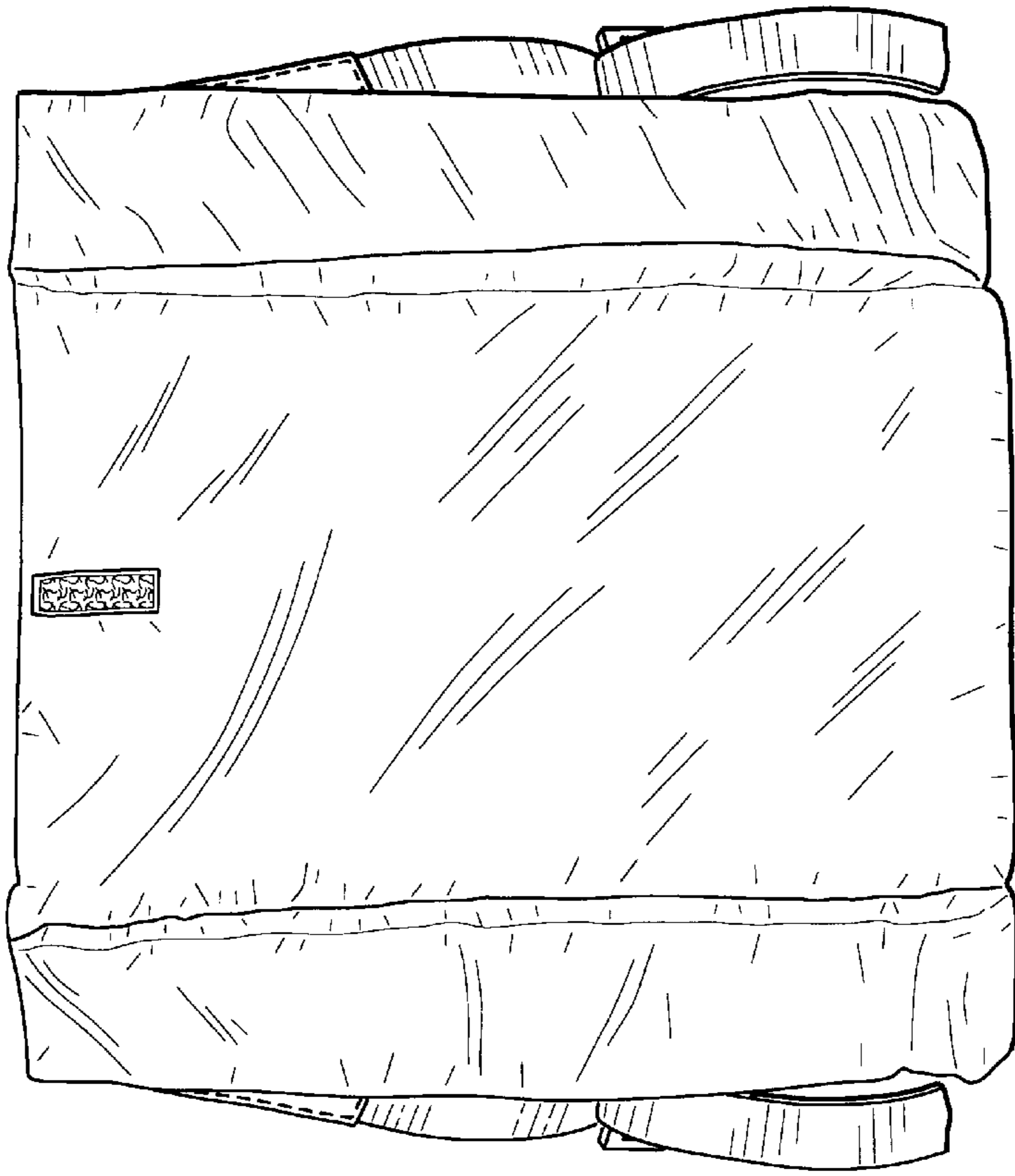

Fig. 4

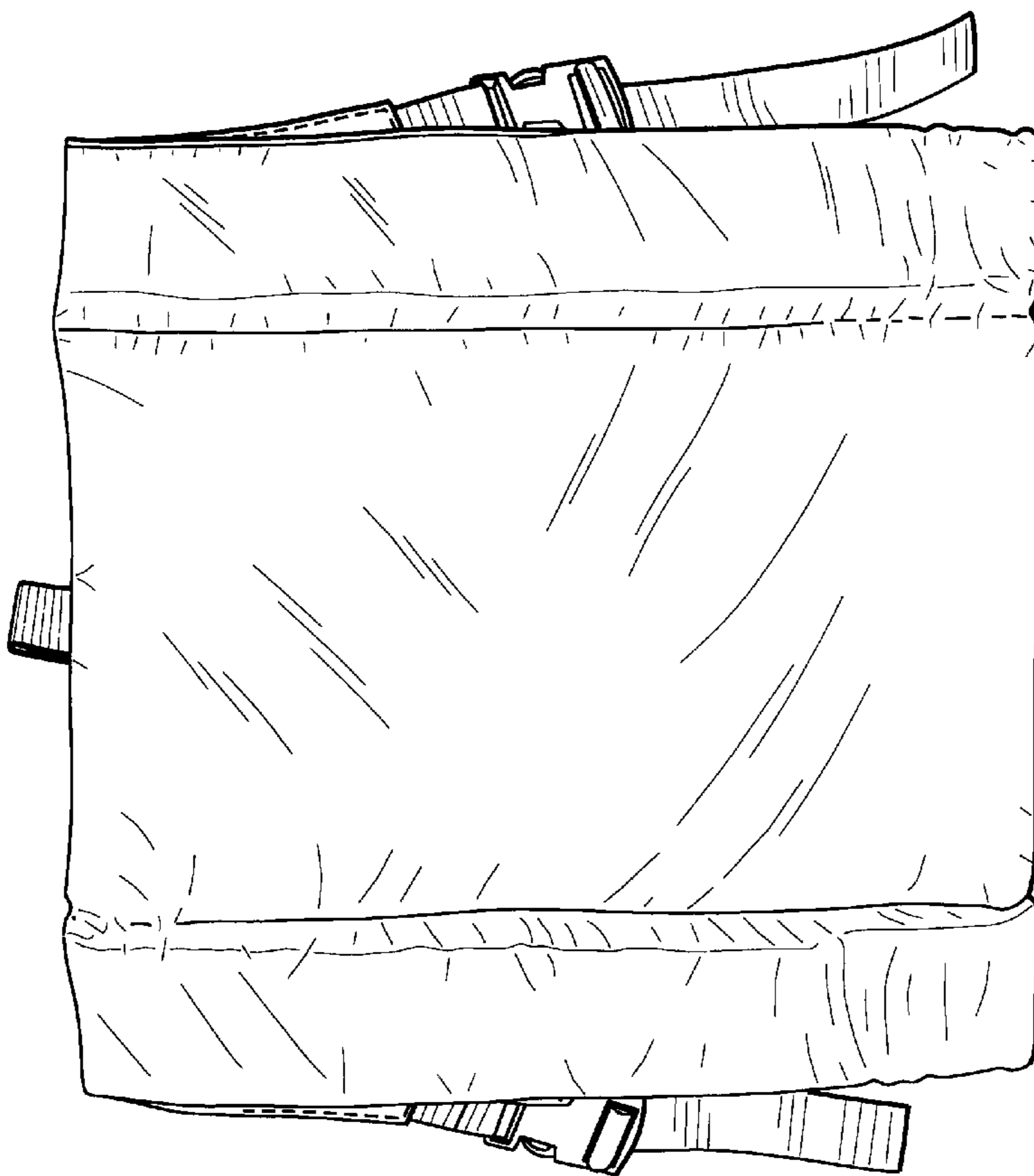

Fig. 3

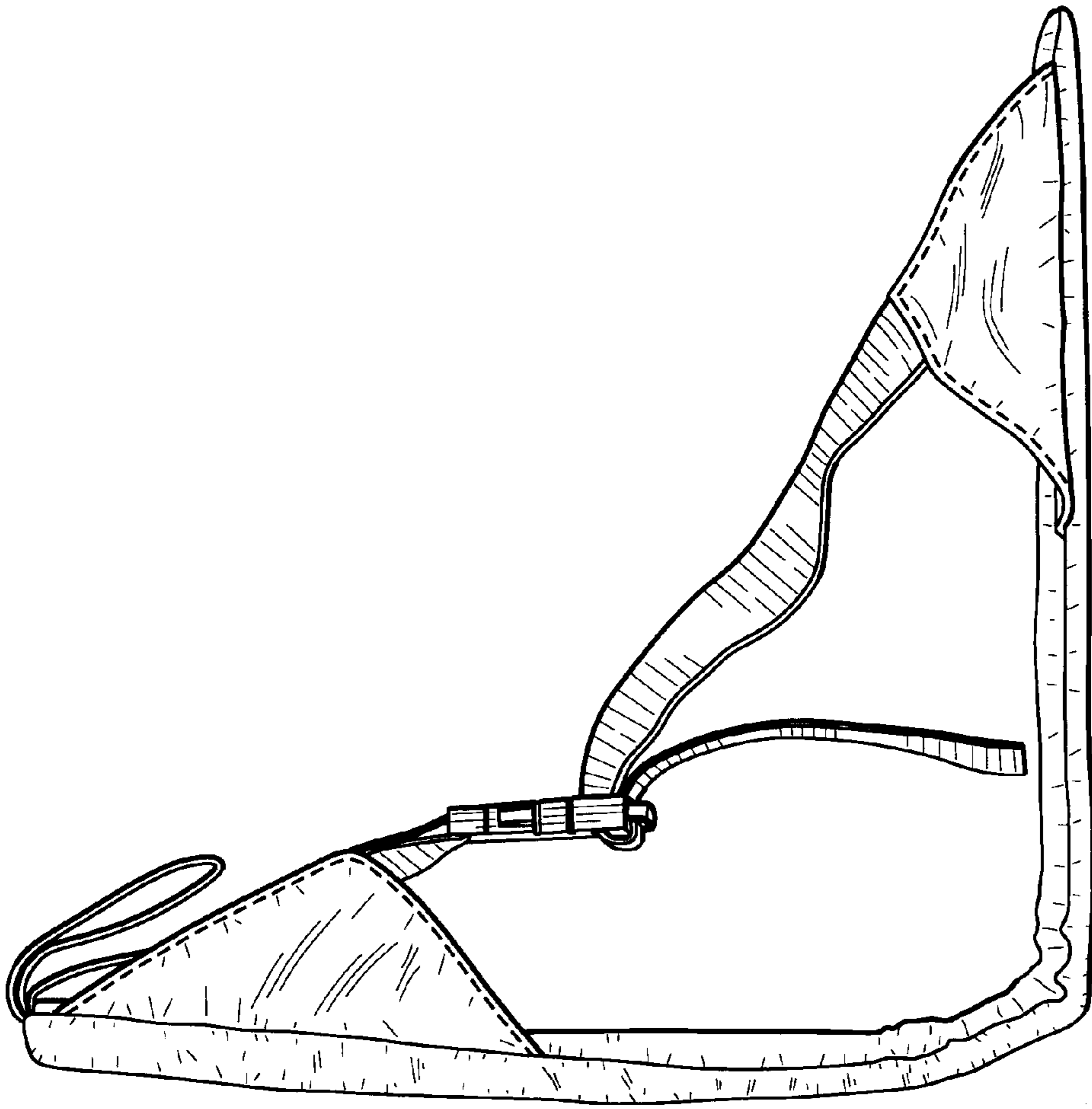

Fig. 5

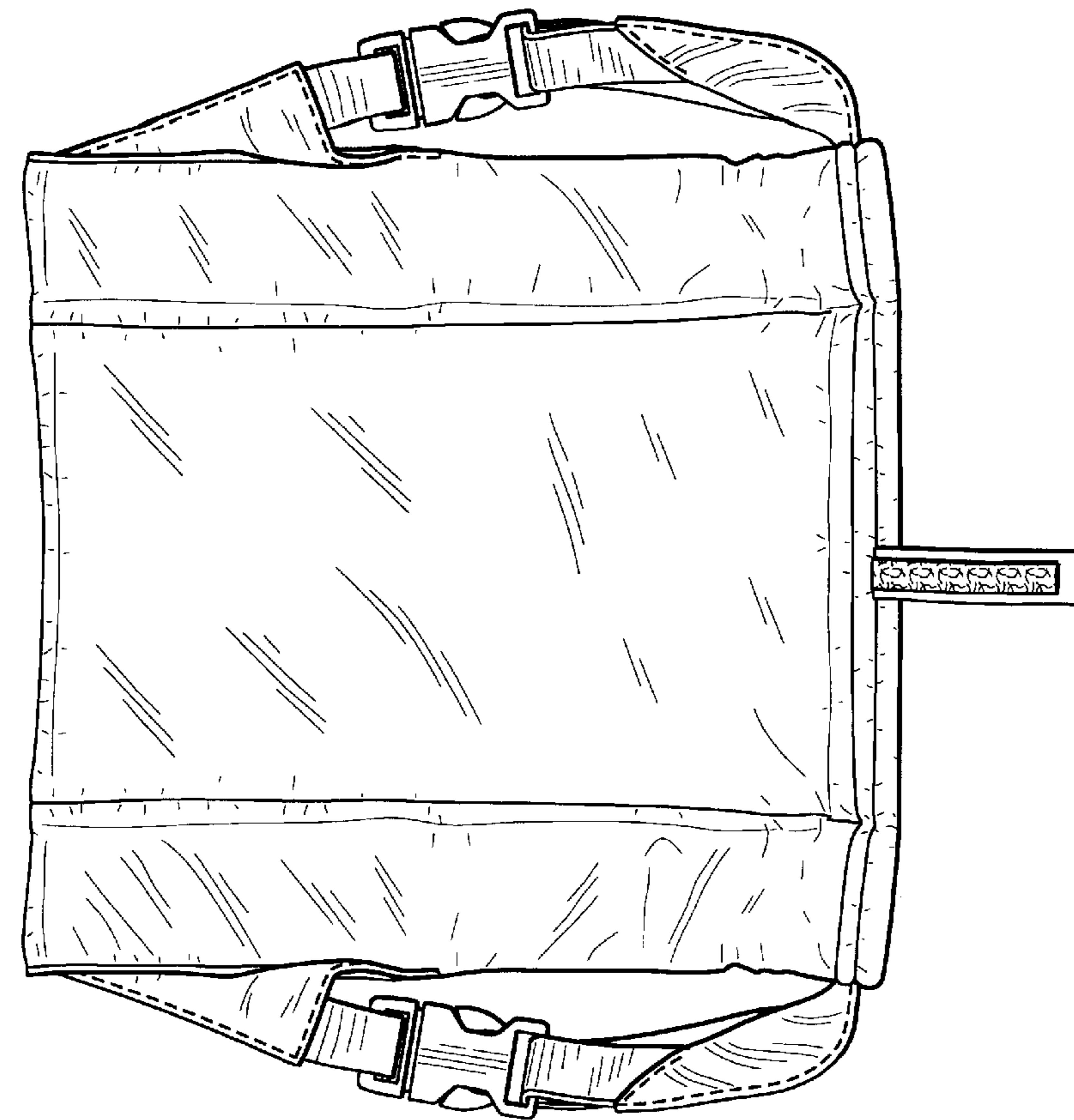

Fig. 6

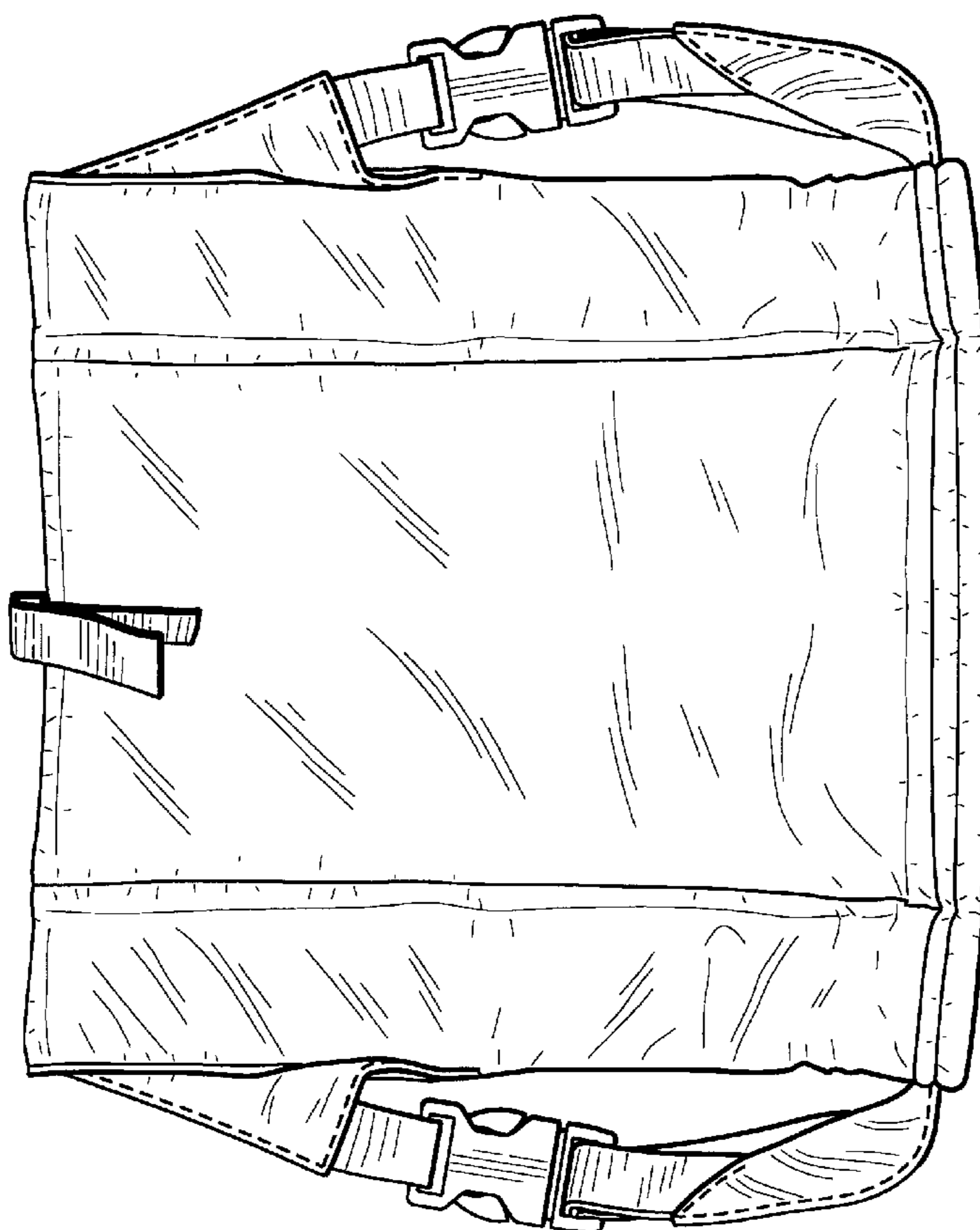

Fig. 7