



US00D449775B1

(12) **United States Design Patent**
Ervolina

(10) **Patent No.:** **US D449,775 S**

(45) **Date of Patent:** **** Oct. 30, 2001**

(54) **MIRROR BRACKET**

3,482,809 * 12/1969 McCall, Jr. 248/489
6,042,078 * 3/2000 Donovan 248/489

(75) Inventor: **Tony J Ervolina**, Costa Mesa, CA (US)

* cited by examiner

(73) Assignee: **Street Scene Manufacturing, Inc.**,
Costa Mesa, CA (US)

Primary Examiner—Pamela Burgess

(74) *Attorney, Agent, or Firm*—Lyon & Lyon LLP

(**) Term: **14 Years**

(57) **CLAIM**

(21) Appl. No.: **29/133,576**

The ornamental design for a mirror bracket, as shown.

(22) Filed: **Nov. 30, 2000**

DESCRIPTION

(51) **LOC (7) Cl.** **08-05**

FIG. 1 is a front perspective view of a mirror bracket showing my new design;

(52) **U.S. Cl.** **D8/380**; D8/380; D8/349;
D8/354; D8/355; D8/350; D8/400; D8/499;
D8/363; 248/466; 248/470.1; 248/476;
248/477; 248/488; 248/489; 248/547; D6/300

FIG. 2 is a front view thereof;

FIG. 3 is a left side view thereof;

FIG. 4 is a bottom view thereof;

FIG. 5 is a rear view thereof;

FIG. 6 is a right side view thereof; and,

FIG. 7 is a top view thereof.

(56) **References Cited**

U.S. PATENT DOCUMENTS

D. 341,074 * 11/1993 Wagner D8/349

1 Claim, 2 Drawing Sheets

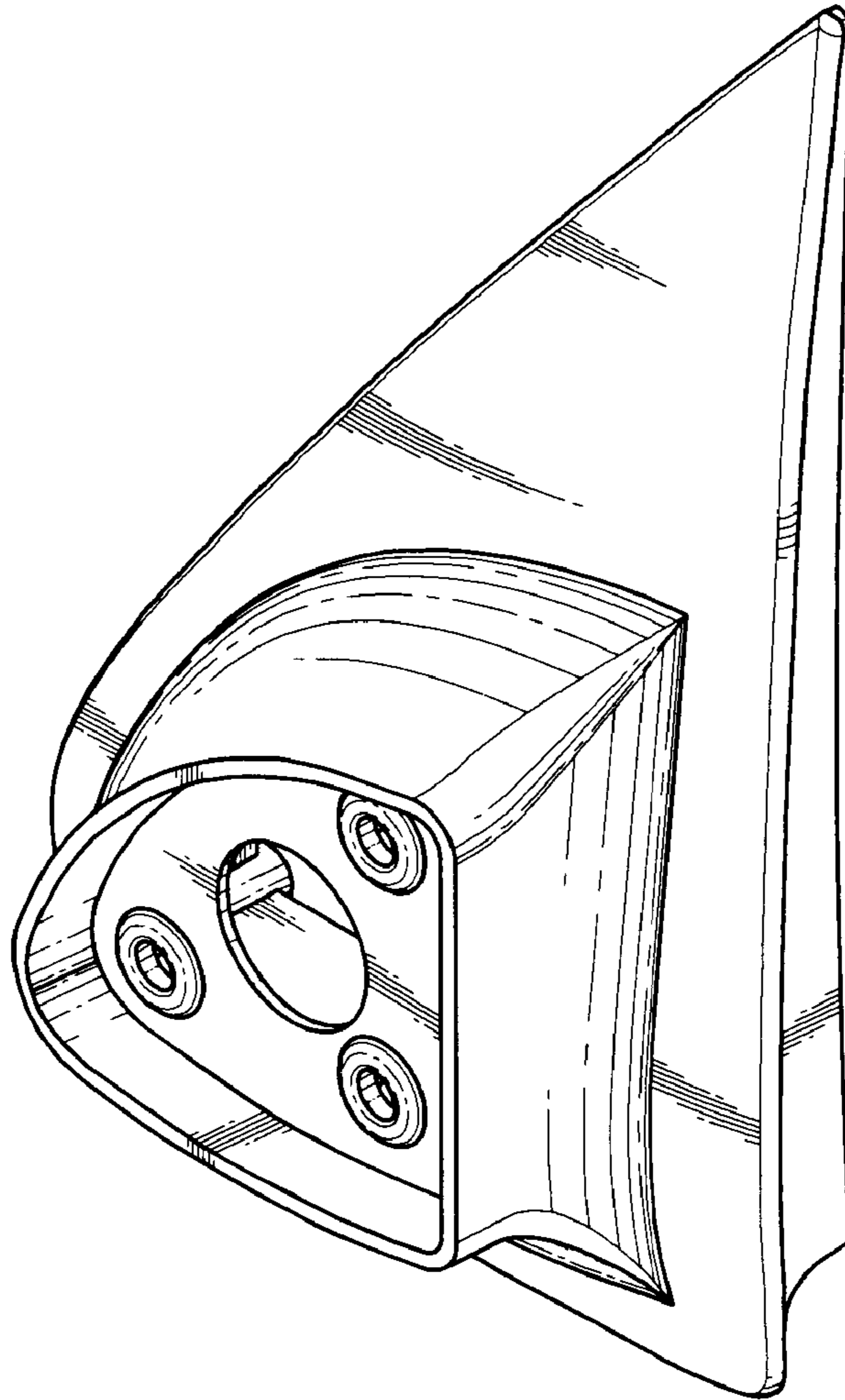

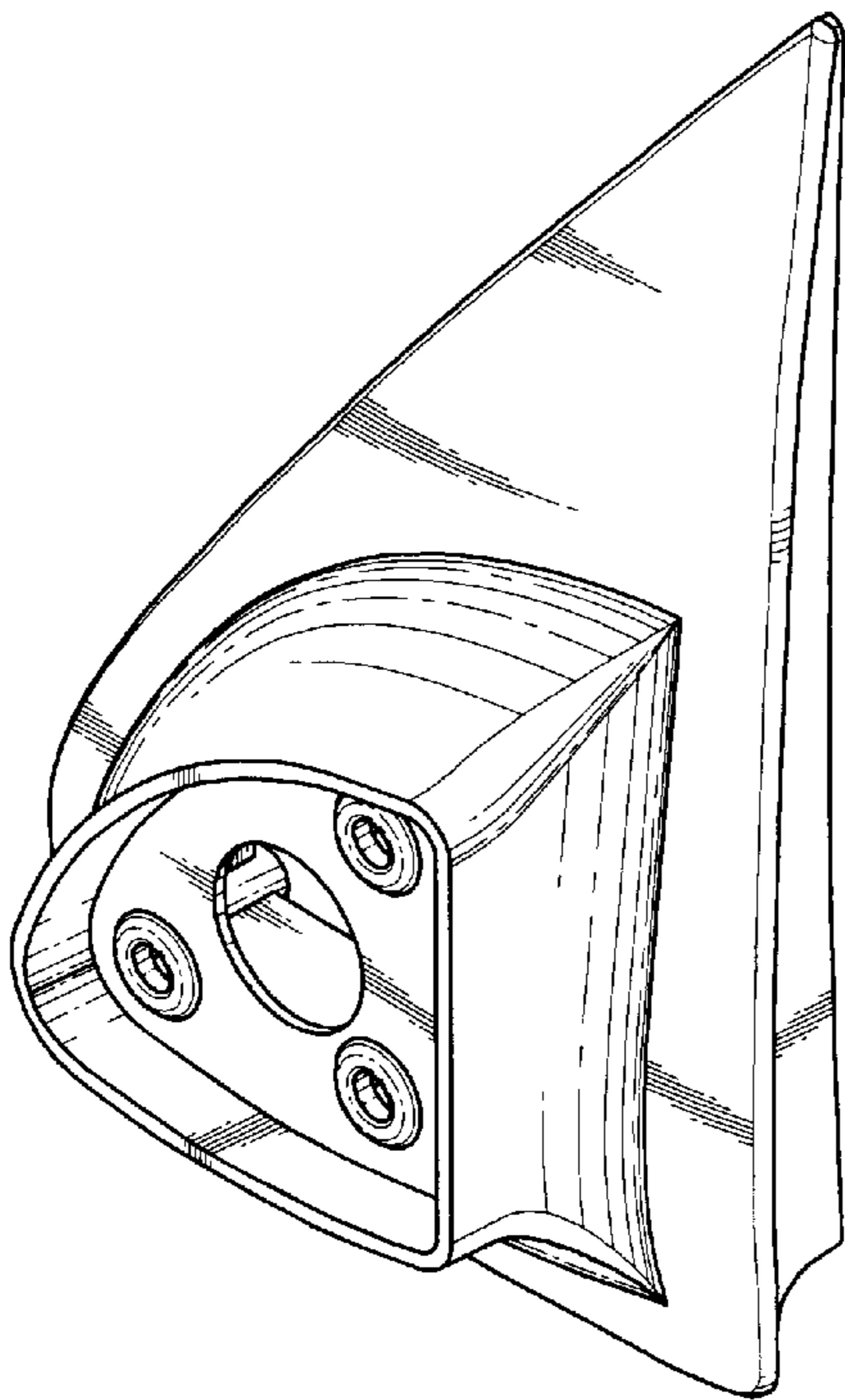

FIG. 1

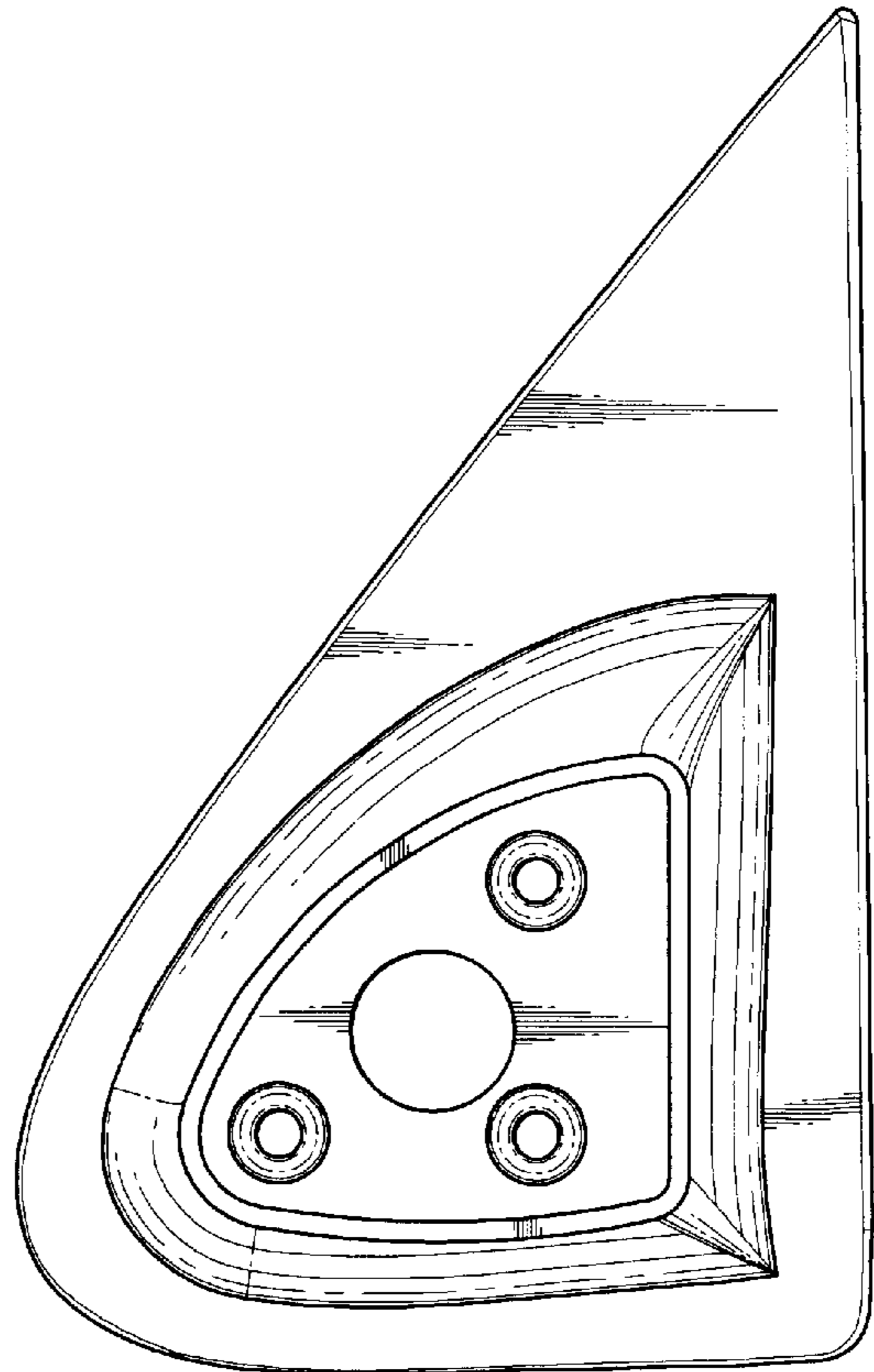

FIG. 2

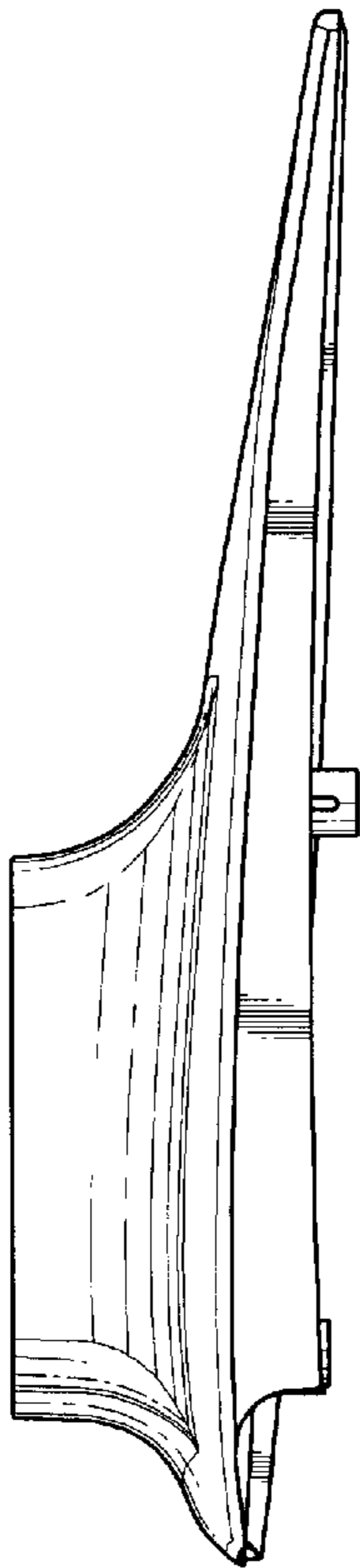

FIG. 3

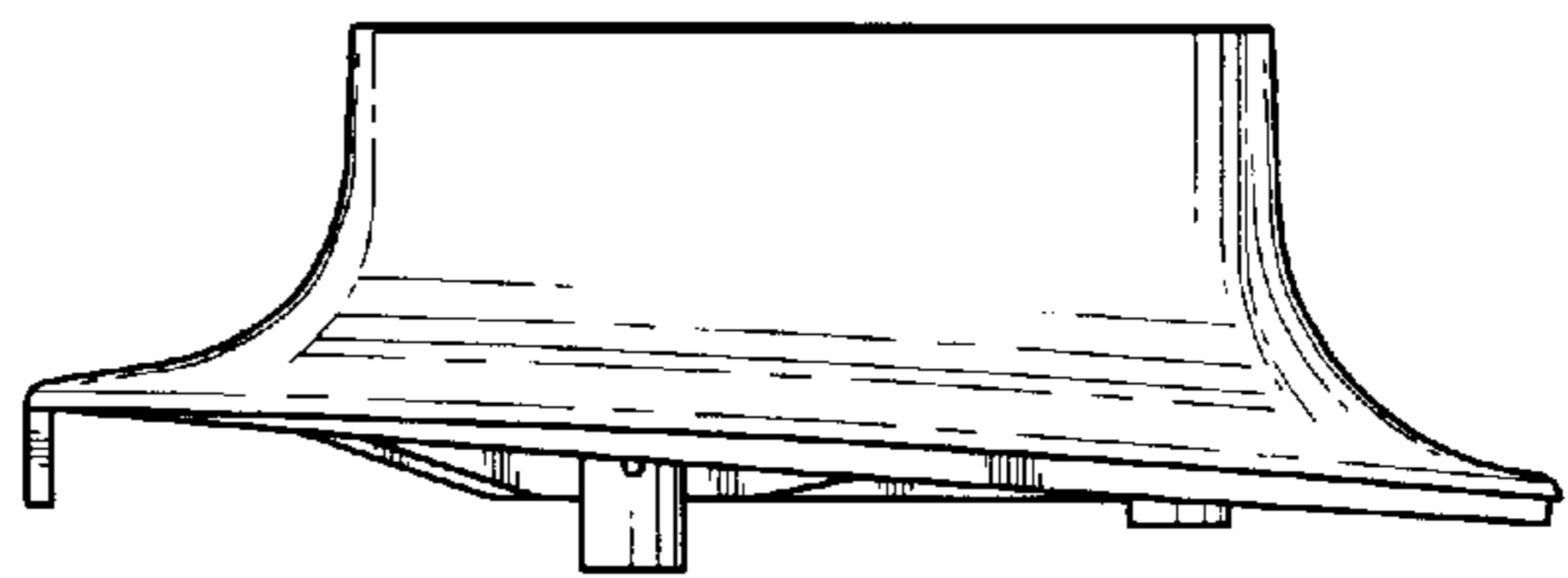

FIG. 4

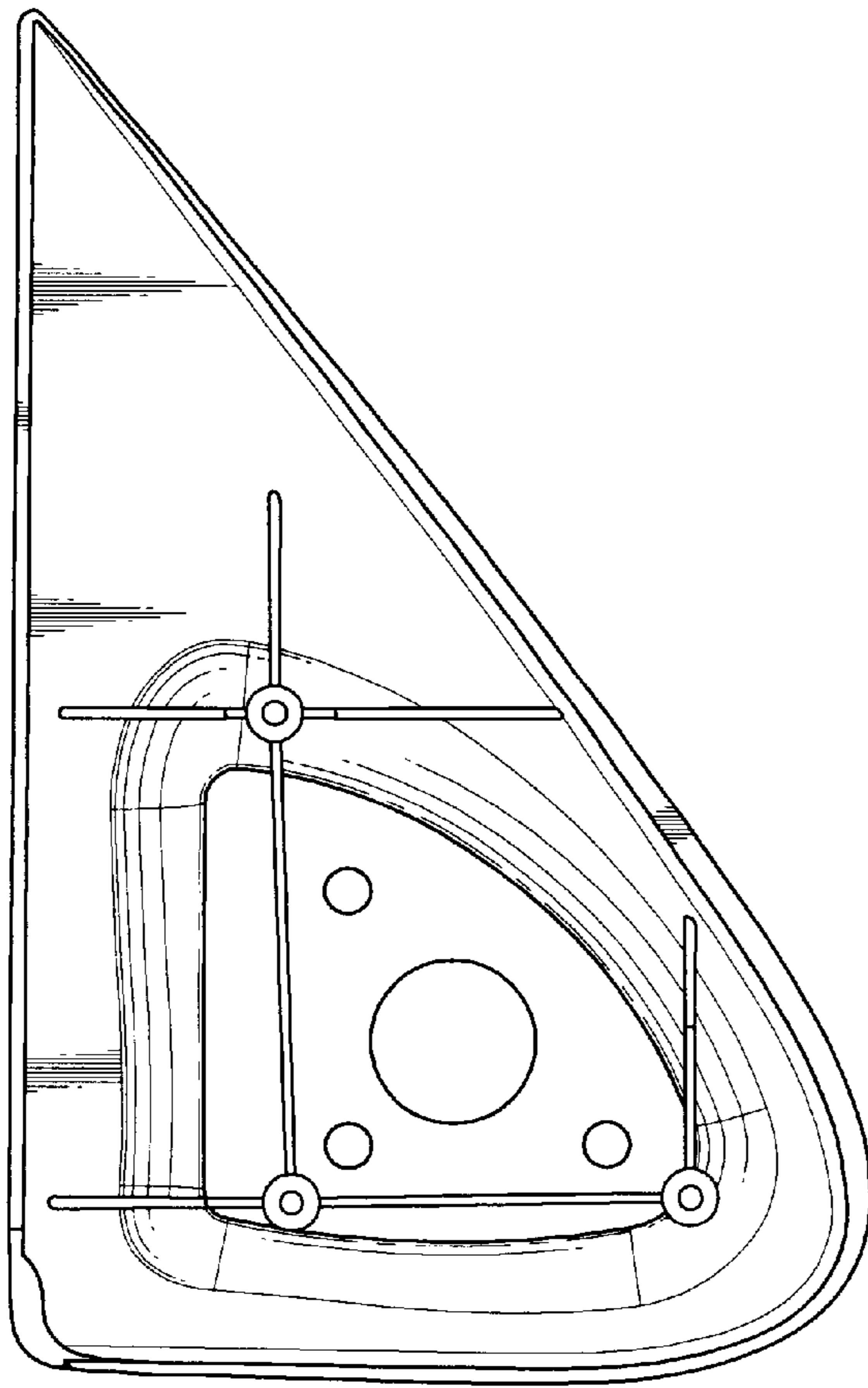

FIG. 5

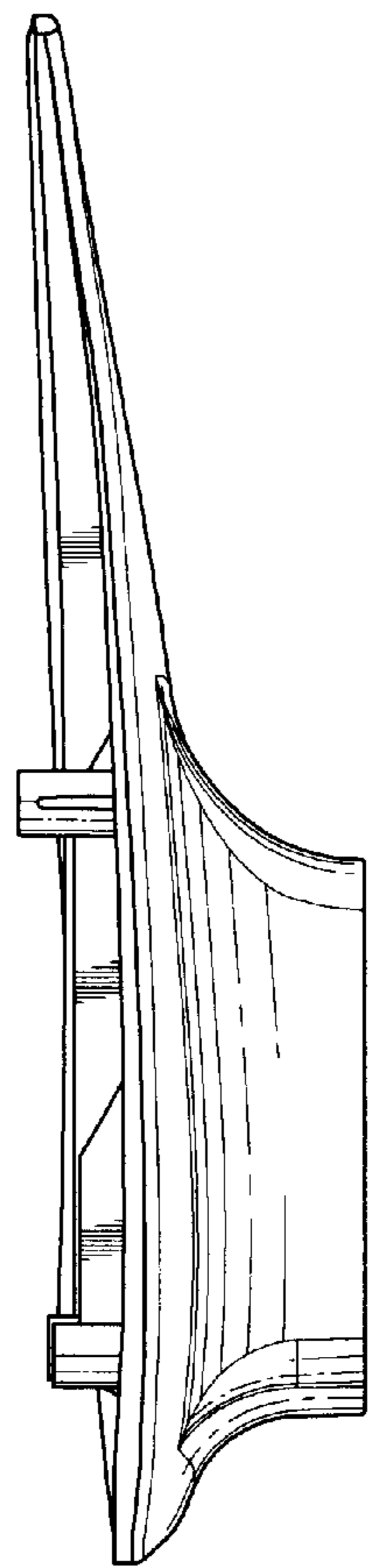

FIG. 6

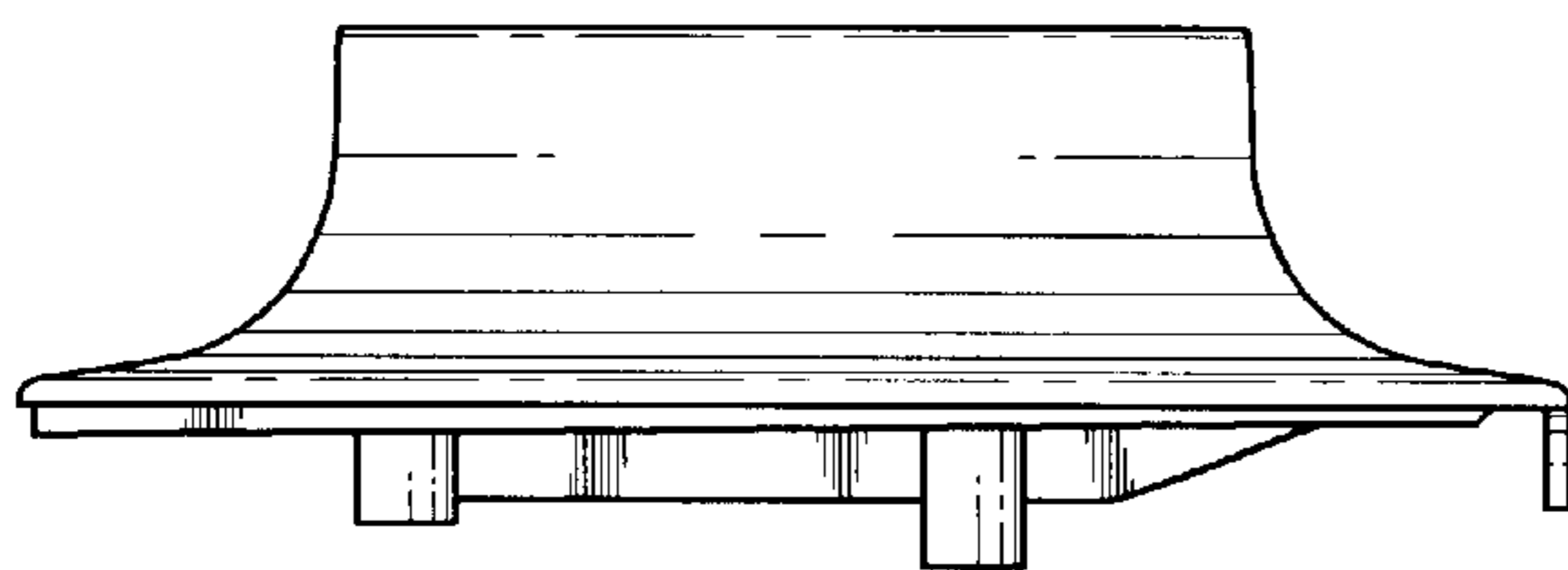

FIG. 7