



US00D449700B1

(12) **United States Design Patent**
Liu et al.

(10) **Patent No.:** **US D449,700 S**

(45) **Date of Patent:** **** Oct. 23, 2001**

(54) **DECORATIVE NIGHT LIGHT WITH CHILD RESISTANT SHADE**

D. 409,317 * 5/1999 Yuen D26/26
D. 430,945 * 9/2000 Ham D26/26
D. 435,125 * 12/2000 Boessel D26/26

(75) Inventors: **Scott Liu**, Loveland; **Gregory DeSwarte**; **Wayne Wichman**, both of Cincinnati, all of OH (US)

* cited by examiner

Primary Examiner—Cynthia E. Ramirez

(73) Assignee: **General Electric Company**, Schenectady, NY (US)

(74) *Attorney, Agent, or Firm*—Pearne & Gordon LLP

(**) Term: **14 Years**

(57) **CLAIM**

The ornamental design for a decorative night light with child resistant shade, as shown and described.

(21) Appl. No.: **29/135,359**

DESCRIPTION

(22) Filed: **Jan. 10, 2001**

(51) **LOC (7) Cl.** **26-05**

(52) **U.S. Cl.** **D26/26**

(58) **Field of Search** D26/26, 24, 25;
362/147, 404, 432, 367, 226, 222, 223

FIG. 1 shows a front perspective view of the decorative night light with child resistant shade according to the invention;

FIG. 2 shows a front elevation view of the night light;

FIG. 3 shows a right side elevation view of the night light the left side elevation view being a mirror image thereof;

FIG. 4 shows a top plan view of the night light;

FIG. 5 shows a rear elevation view of the night light; and,

FIG. 6 shows a bottom plan view of the night light.

(56) **References Cited**

U.S. PATENT DOCUMENTS

D. 379,539 * 5/1997 Yuen D26/26
D. 393,912 * 4/1998 Yuen D26/26

1 Claim, 3 Drawing Sheets

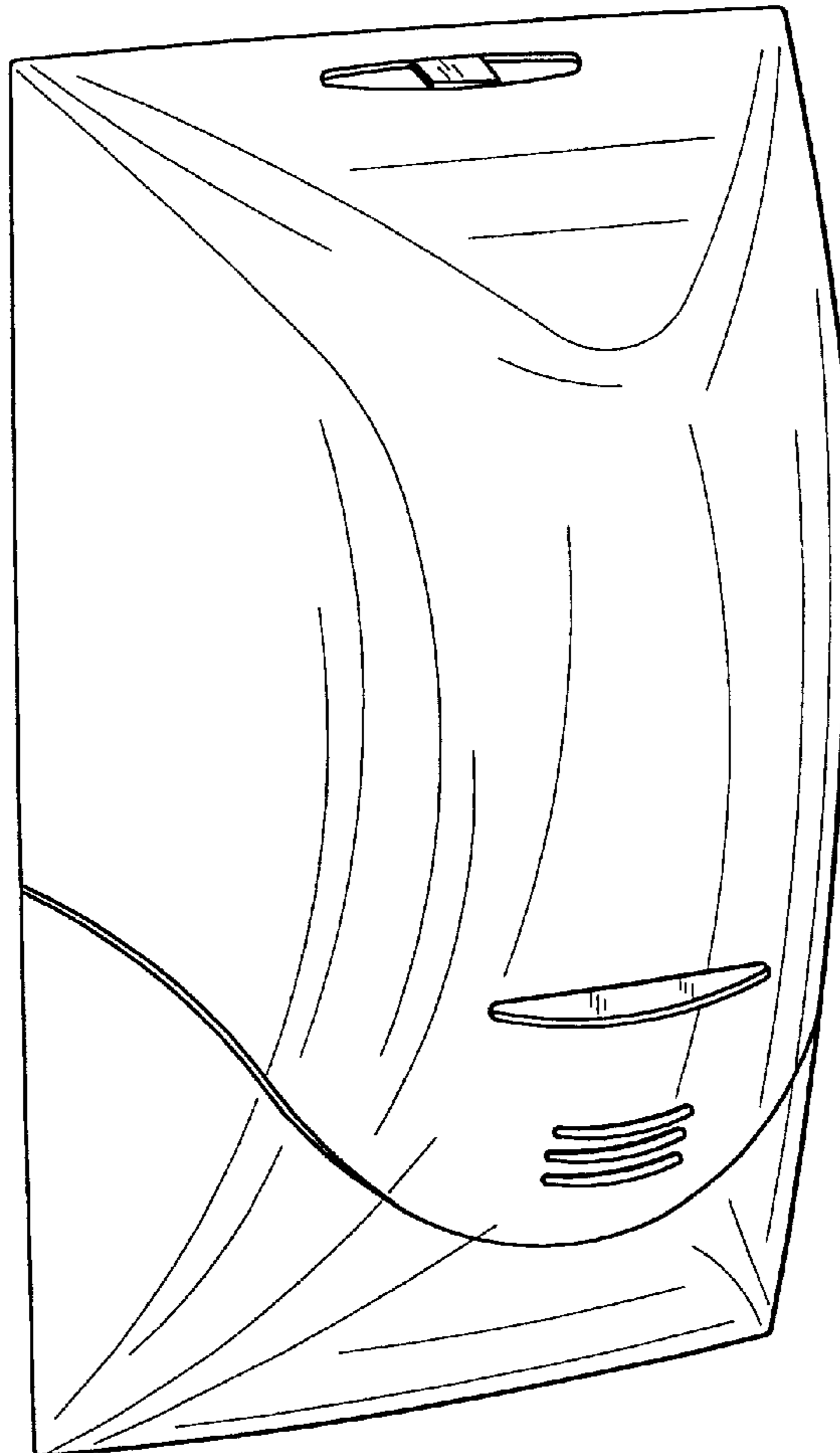

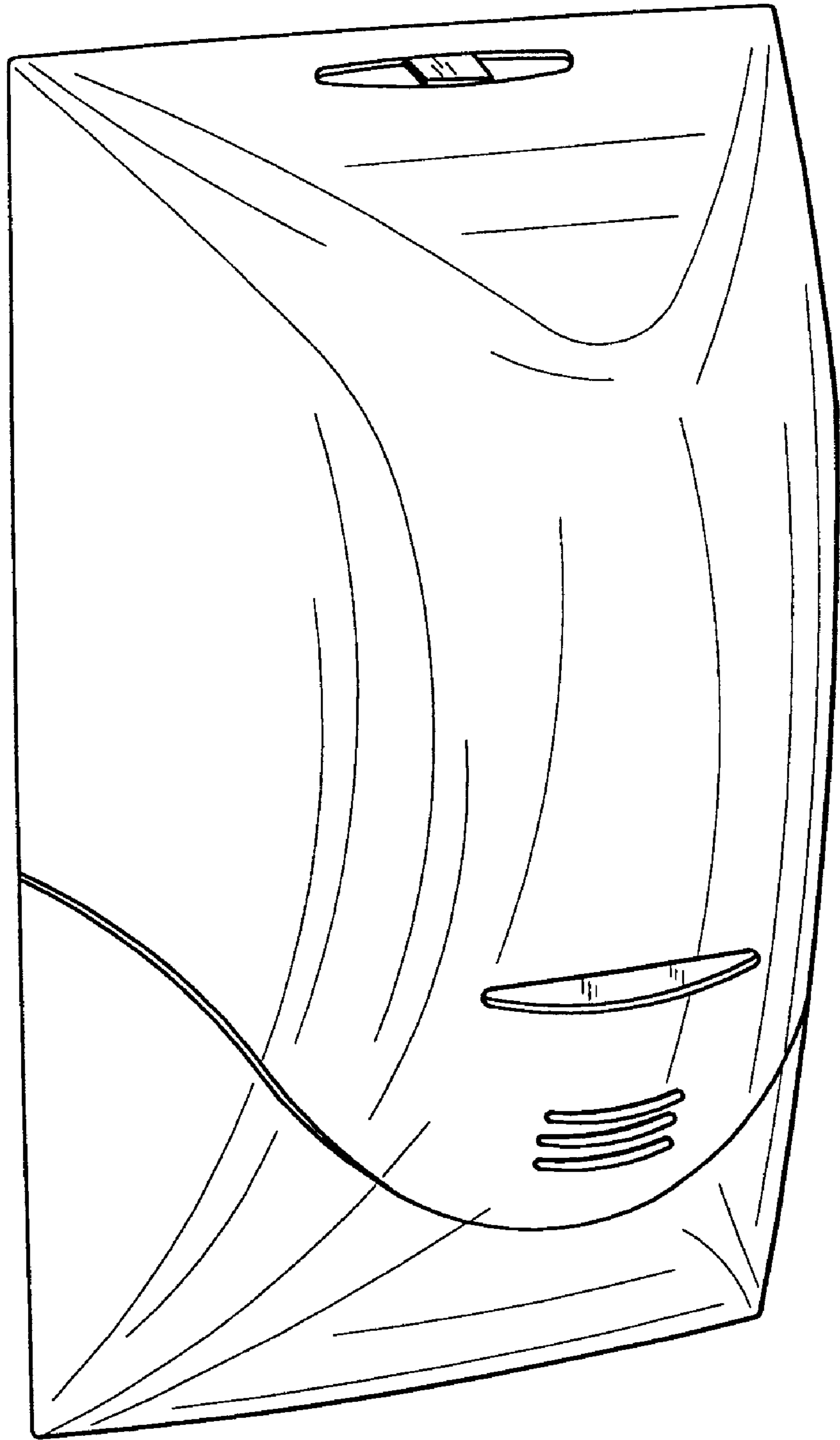

FIG. 1

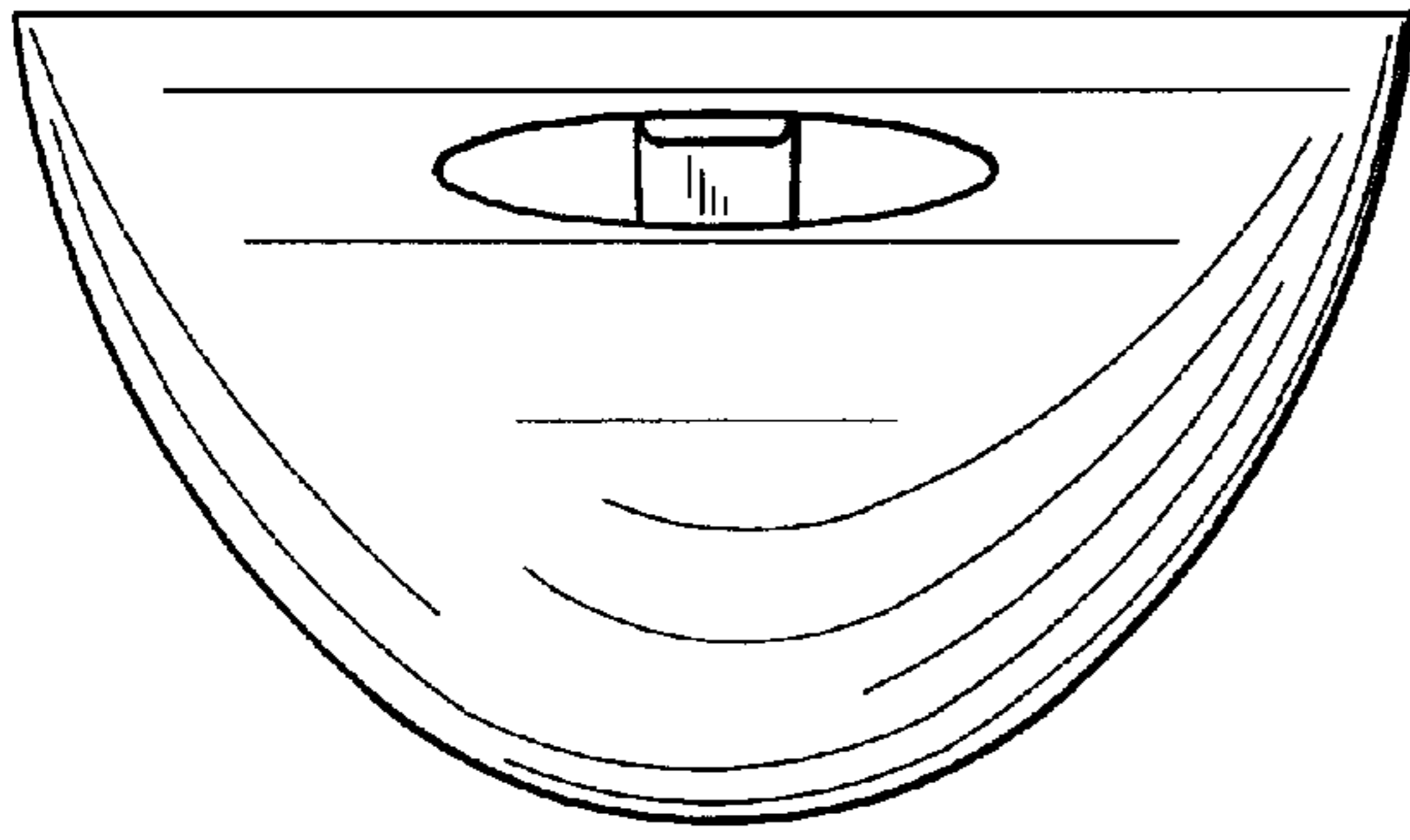

FIG. 4

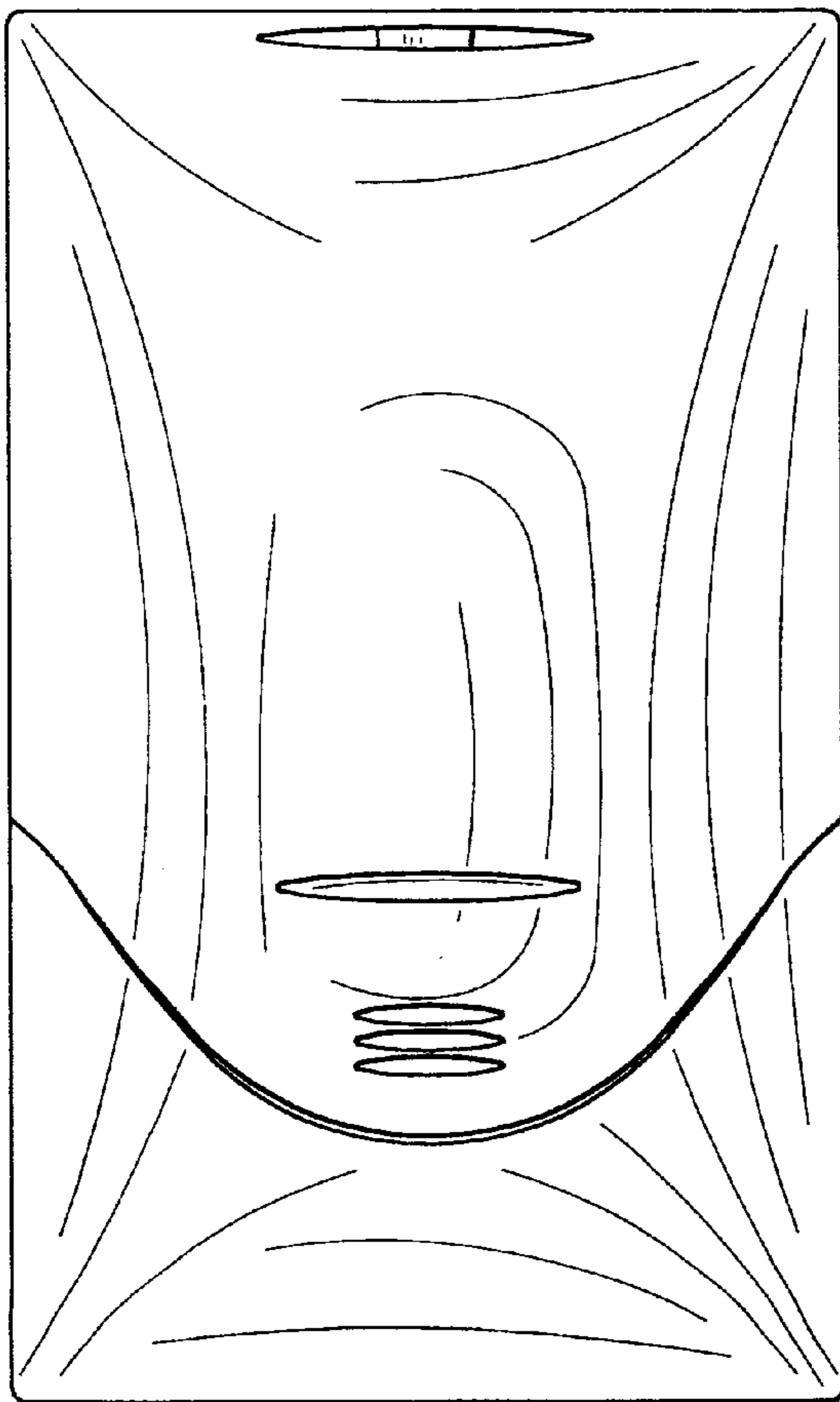

FIG. 2

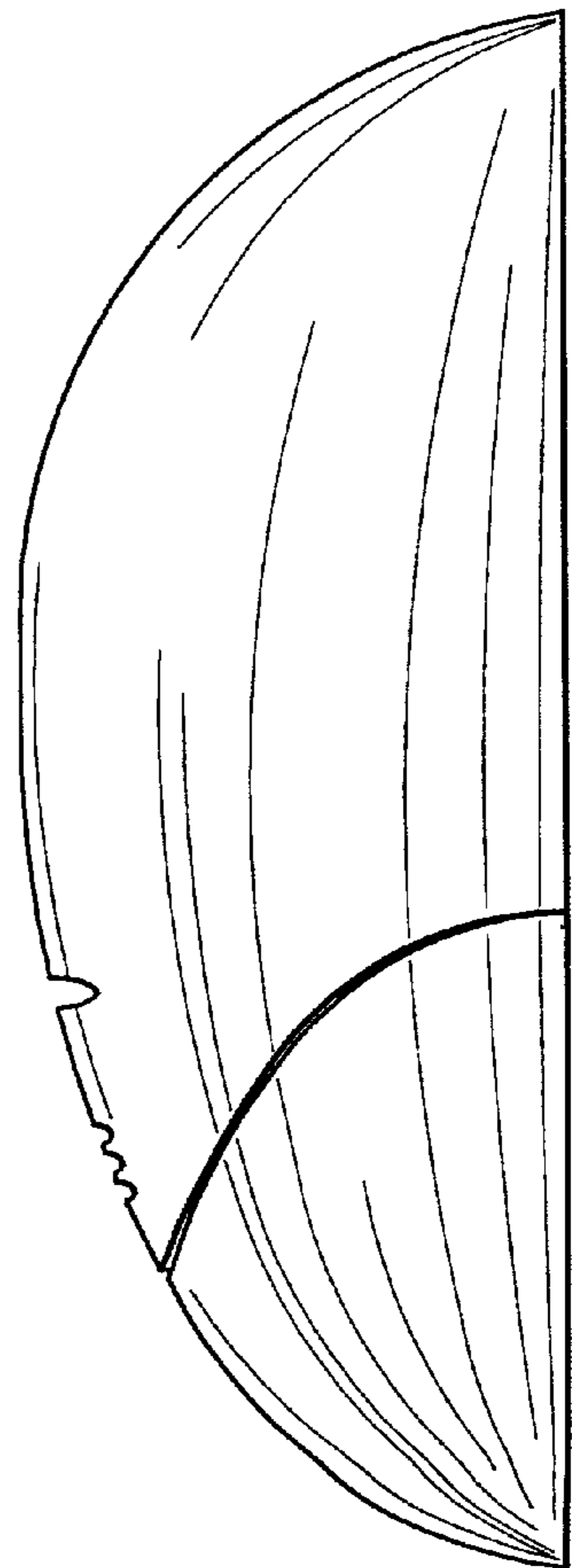

FIG. 3

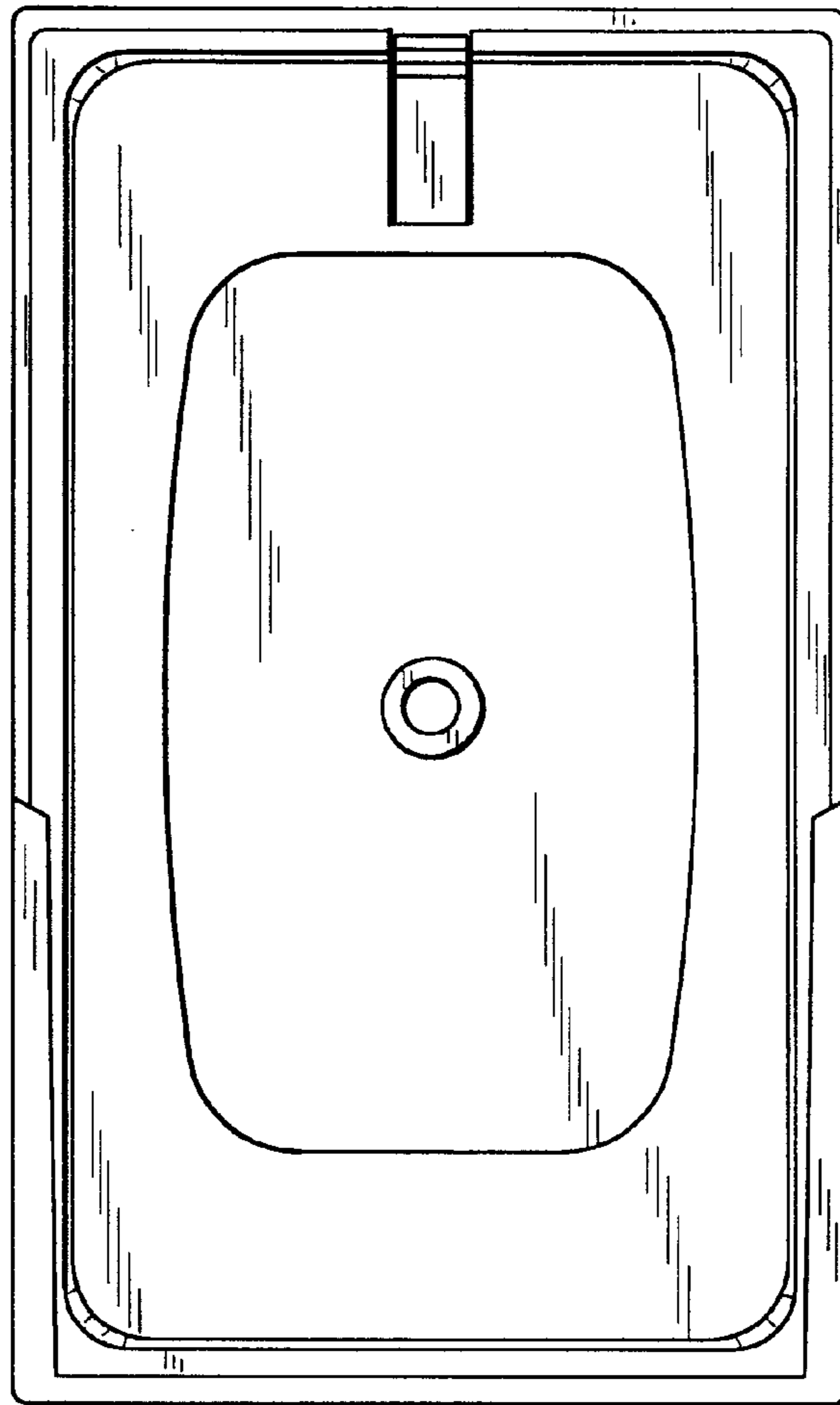

FIG. 5

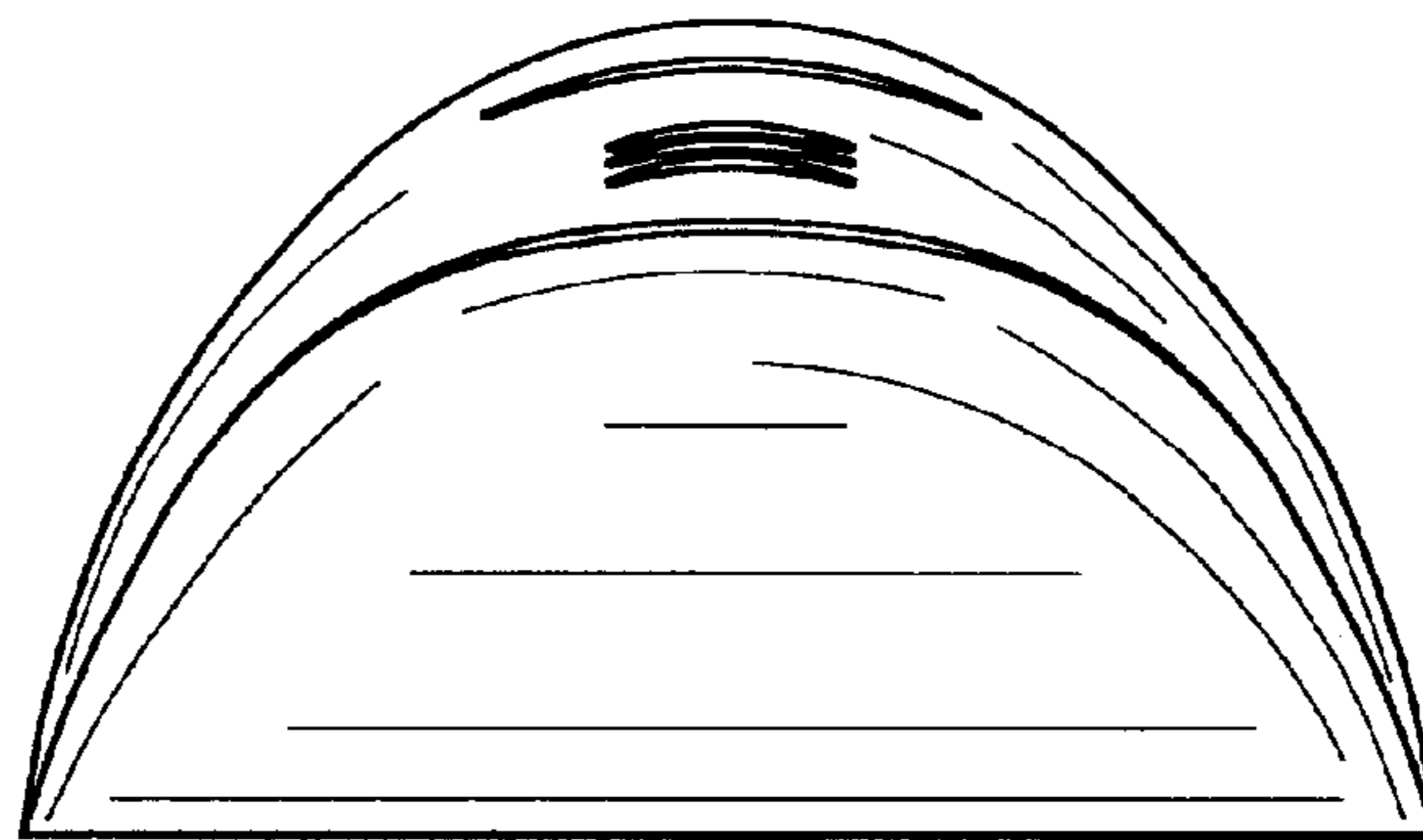

FIG. 6