



US00D449654B2

(12) **United States Design Patent**
Petersen et al.

(10) **Patent No.:** **US D449,654 S**

(45) **Date of Patent:** **** Oct. 23, 2001**

(54) **SIGN**

(75) Inventors: **Jörn M Petersen**, Nufringen; **Thomas S Ertel**, Tübingen, both of (DE)

(73) Assignee: **DaimlerChrysler Corporation**, Auburn Hills, MI (US)

(**) Term: **14 Years**

(21) Appl. No.: **29/125,926**

(22) Filed: **Jul. 5, 2000**

(51) **LOC (7) Cl.** **20-02**

(52) **U.S. Cl.** **D20/39**

(58) **Field of Search** D20/10, 40, 41;
40/584, 564, 605, 606, 611, 612

(56) **References Cited**

U.S. PATENT DOCUMENTS

D. 249,555	9/1978	Barr	D25/21
D. 249,556	9/1978	Barr	D25/21
D. 249,557	9/1978	Barr	D25/21
D. 260,819	9/1981	Baffo	D25/33
D. 261,044	9/1981	Baffo	D25/33
D. 262,825	1/1982	Haak	D25/25
D. 265,424	7/1982	Kennedy et al.	D25/25
D. 270,375	8/1983	Cavalié	D25/74
D. 294,393	2/1988	Adcock	D25/56
D. 296,473	6/1988	Hooker	D25/1
D. 355,677 *	2/1995	Taylor	D20/10
D. 395,677 *	6/1998	Gongora et al.	D20/10
D. 395,678 *	6/1998	Treille	D20/41
D. 397,154 *	8/1998	Hart	D20/10
D. 420,053 *	2/2000	Voight	D20/10

* cited by examiner

Primary Examiner—Marcus A. Jackson

(74) *Attorney, Agent, or Firm*—Lisa K. Mack

(57) **CLAIM**

The ornamental design for a sign, as shown and described.

DESCRIPTION

FIG. 1 is a front perspective view of the sign of the first embodiment;

FIG. 2 is a front view of the sign, it being understood that the opposite side not shown is a substantial mirror image thereof;

FIG. 3 is a left side view of the sign, it being understood that the opposite side not shown is a substantial mirror image thereof;

FIG. 4 is a top view of the sign;

FIG. 5 is a bottom view of the sign;

FIG. 6 is a front perspective view of the sign of the second embodiment;

FIG. 7 is a front view of the sign of the second embodiment, it being understood that the opposite side not shown is a substantial mirror image thereof;

FIG. 8 is a left side view of the sign of the second embodiment, it being understood that the opposite side not shown is a substantial mirror image thereof;

FIG. 9 is a top view of the sign of the second embodiment;

FIG. 10 is a bottom view of the sign of the second embodiment;

FIG. 11 is a front perspective view of the sign of the third embodiment;

FIG. 12 is a front view of the sign of the third embodiment, it being understood that the opposite side not shown is a substantial mirror image thereof;

FIG. 13 is a left side view of the sign of the third embodiment, it being understood that the opposite side not shown is a substantial mirror image thereof;

FIG. 14 is a top view of the sign of the third embodiment; and,

FIG. 15 is a bottom view of the sign of the third embodiment.

1 Claim, 5 Drawing Sheets

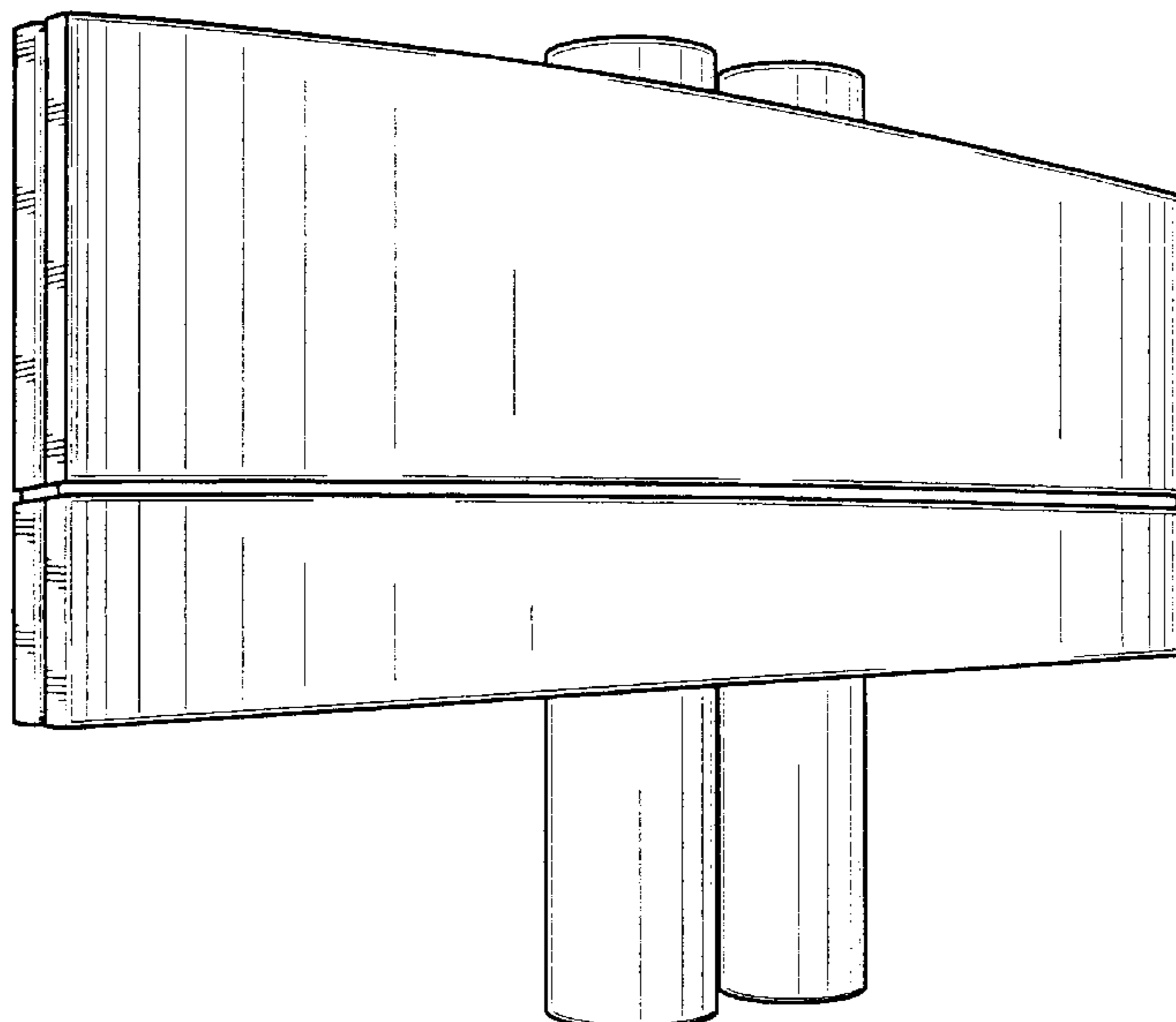

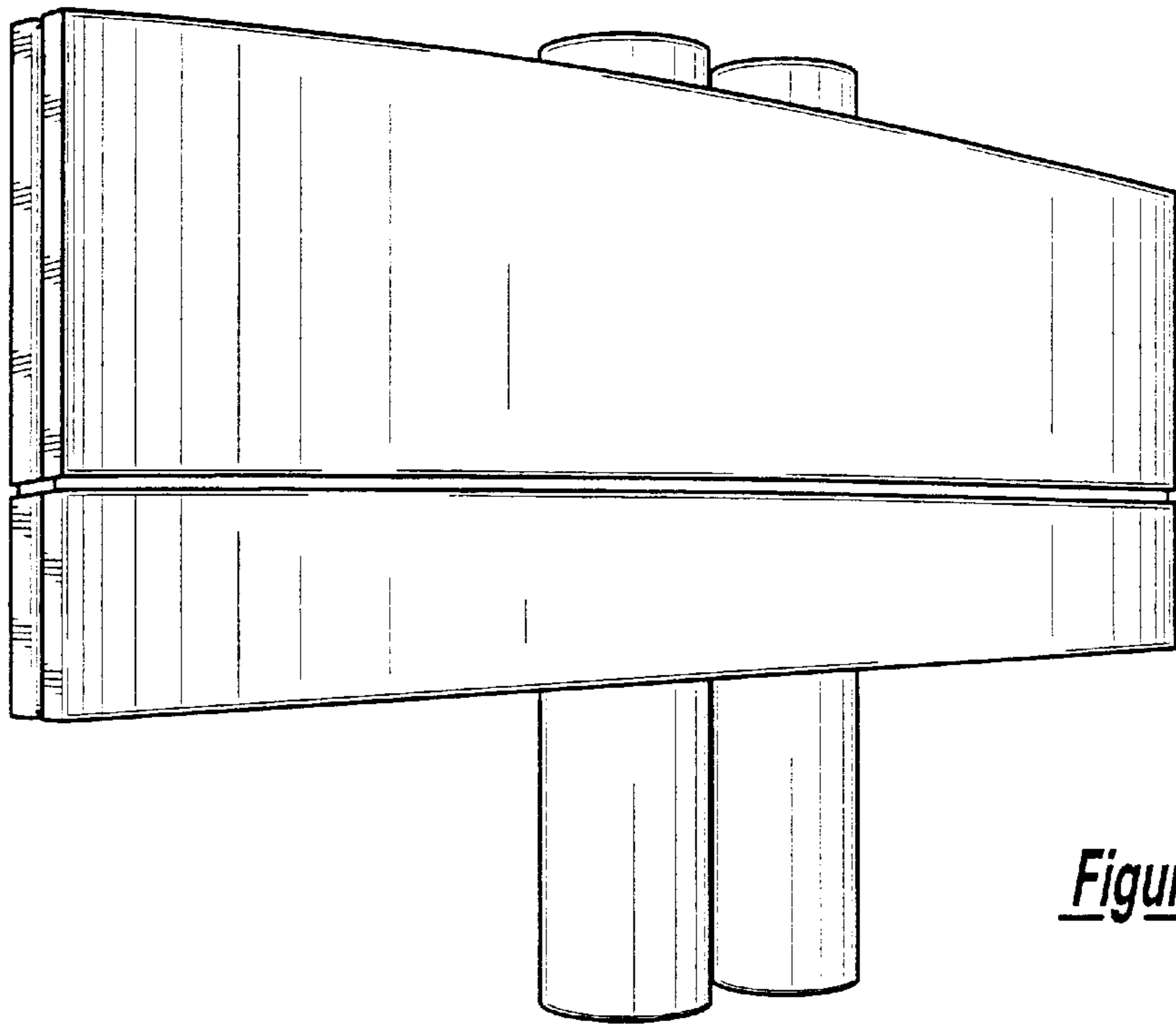

Figure - 1

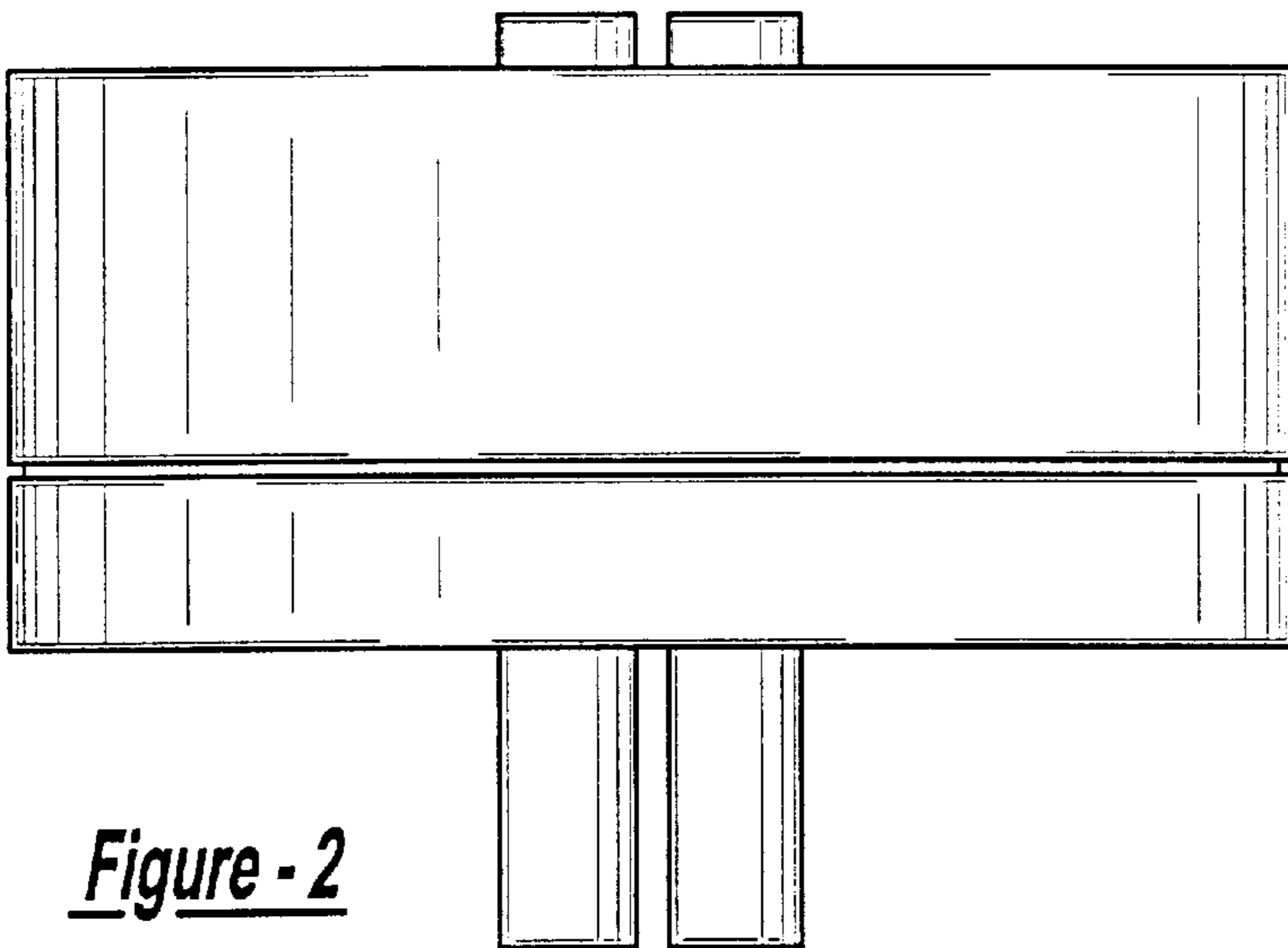

Figure - 2

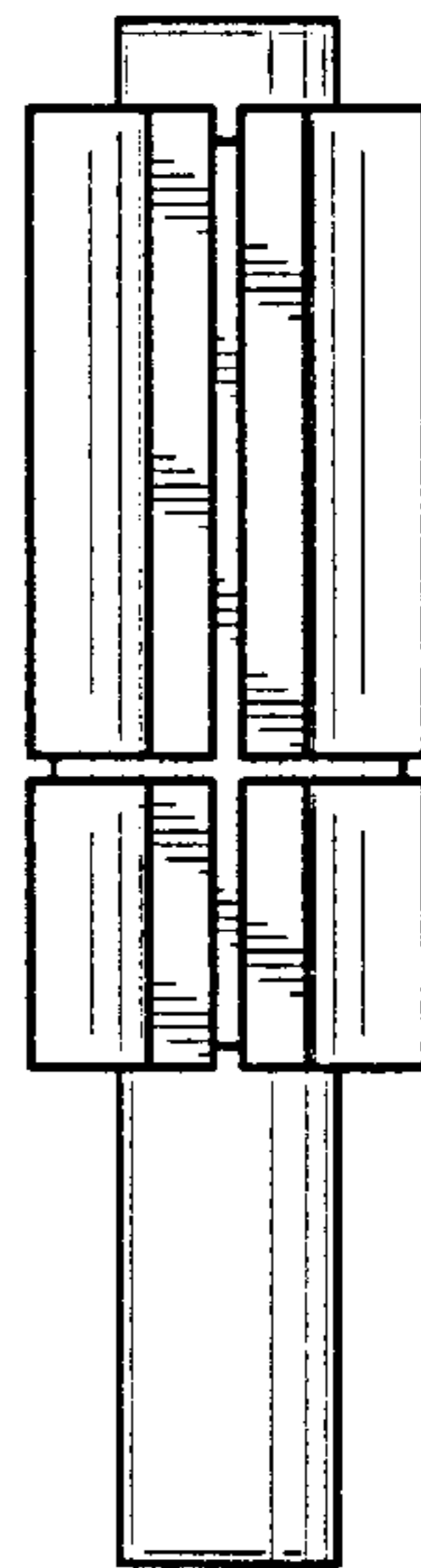

Figure - 3

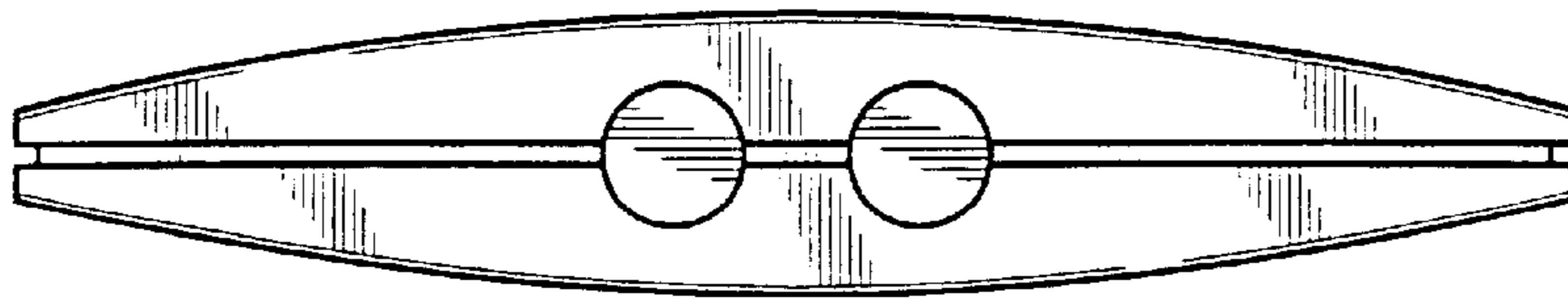

Figure - 4

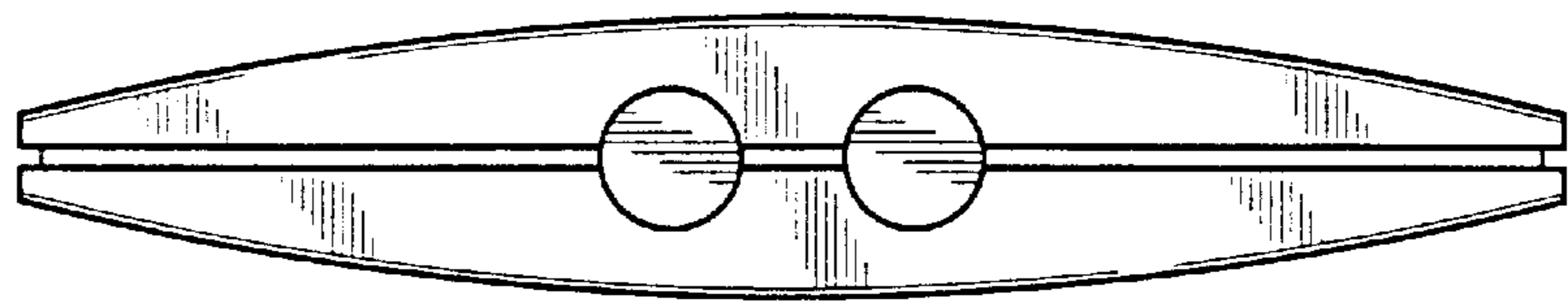

Figure - 5

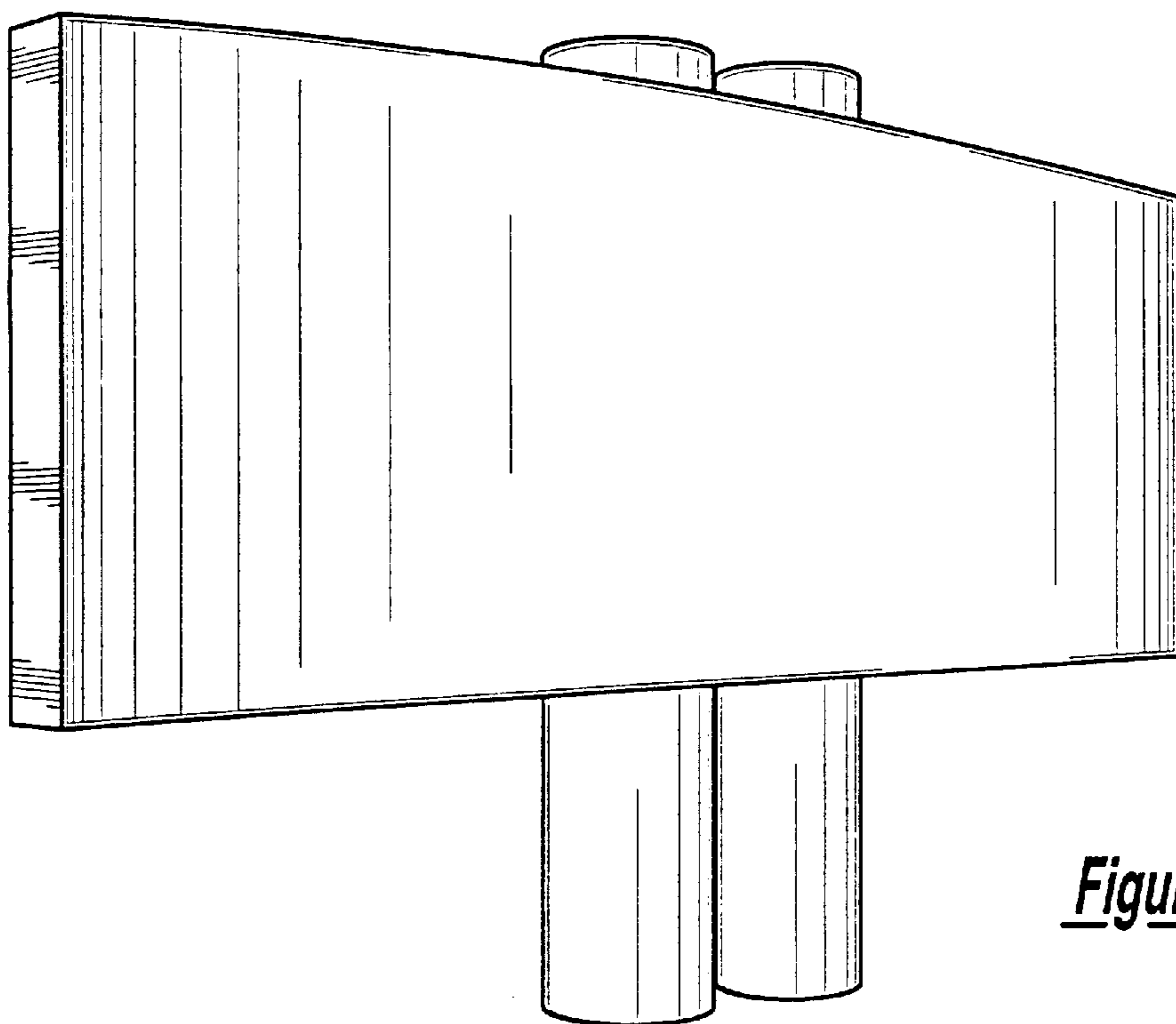

Figure - 6

Figure - 7

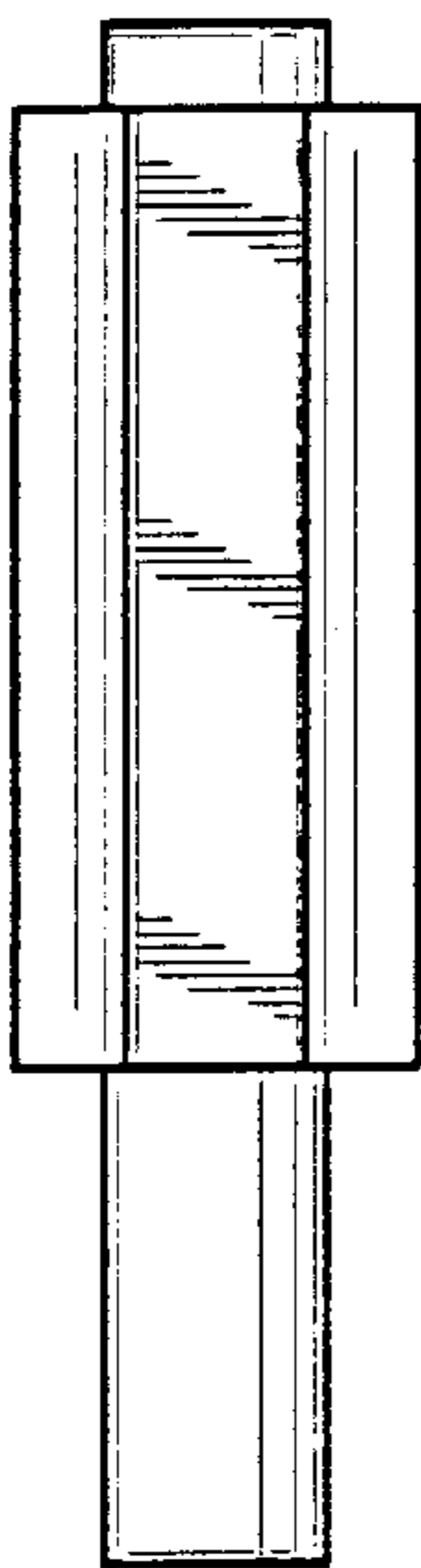
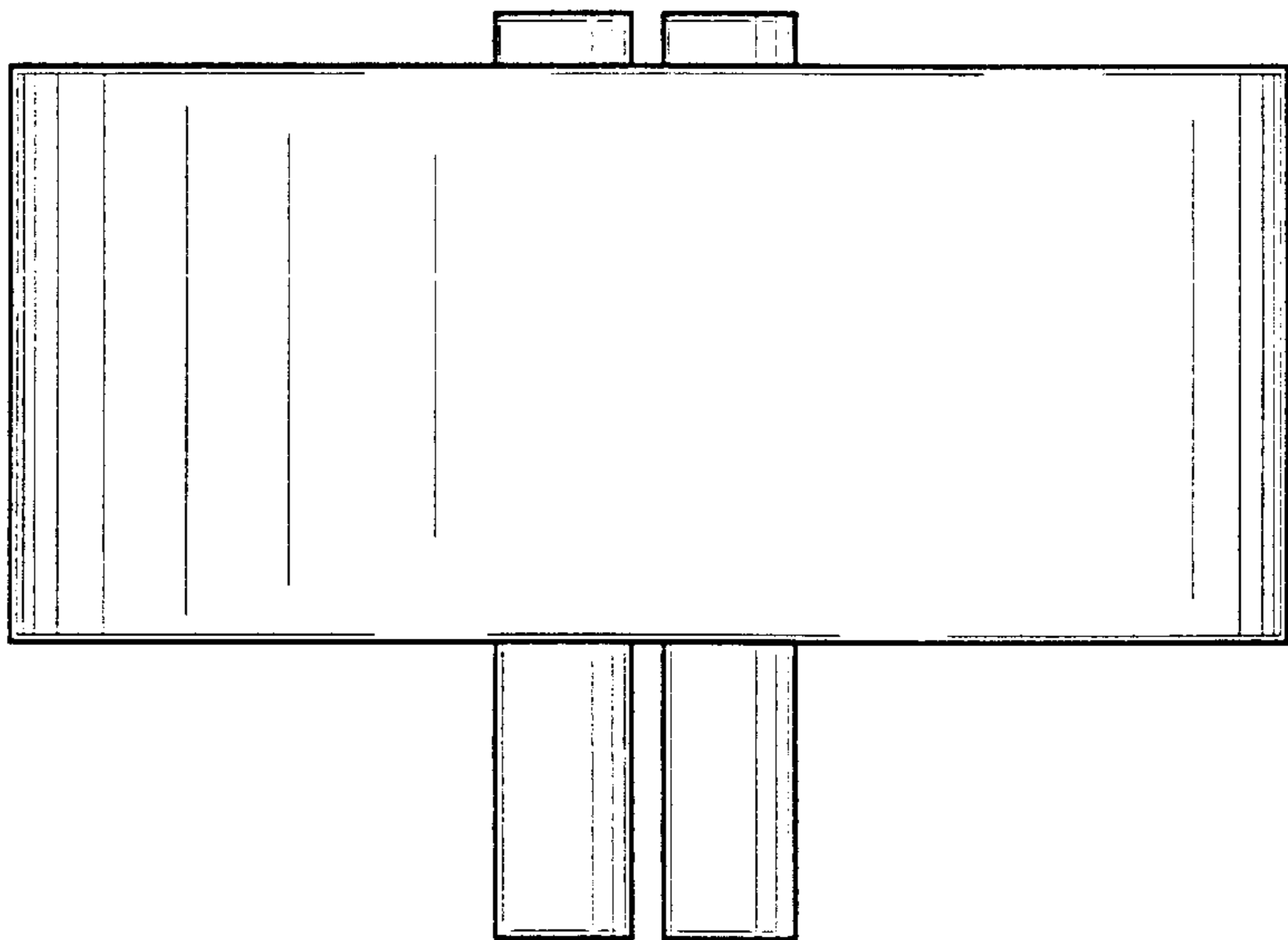

Figure - 8

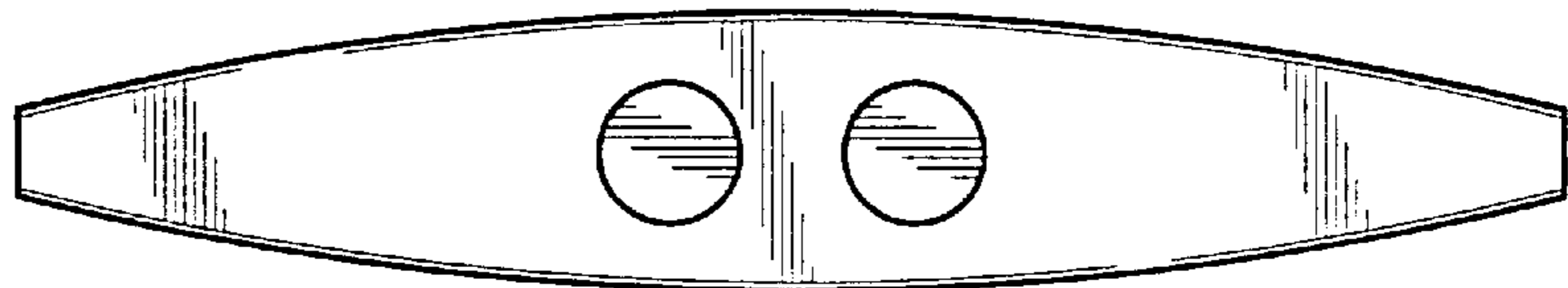

Figure - 9

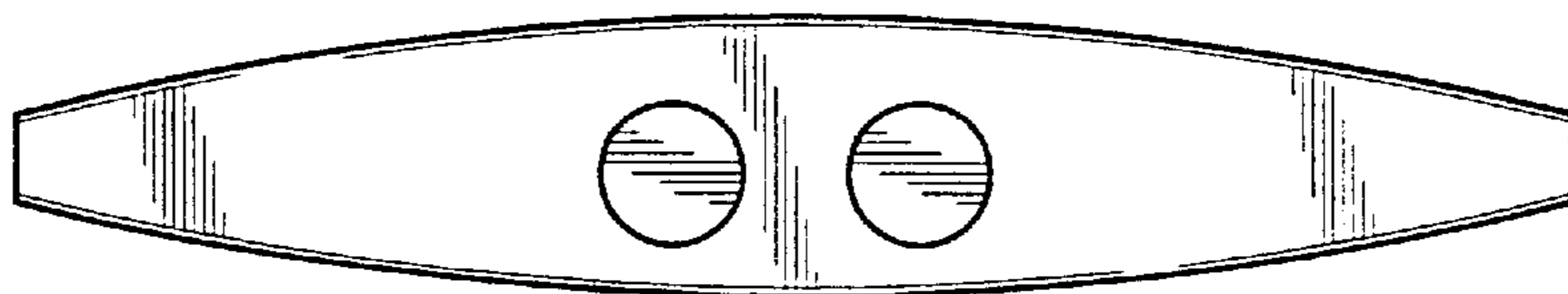

Figure - 10

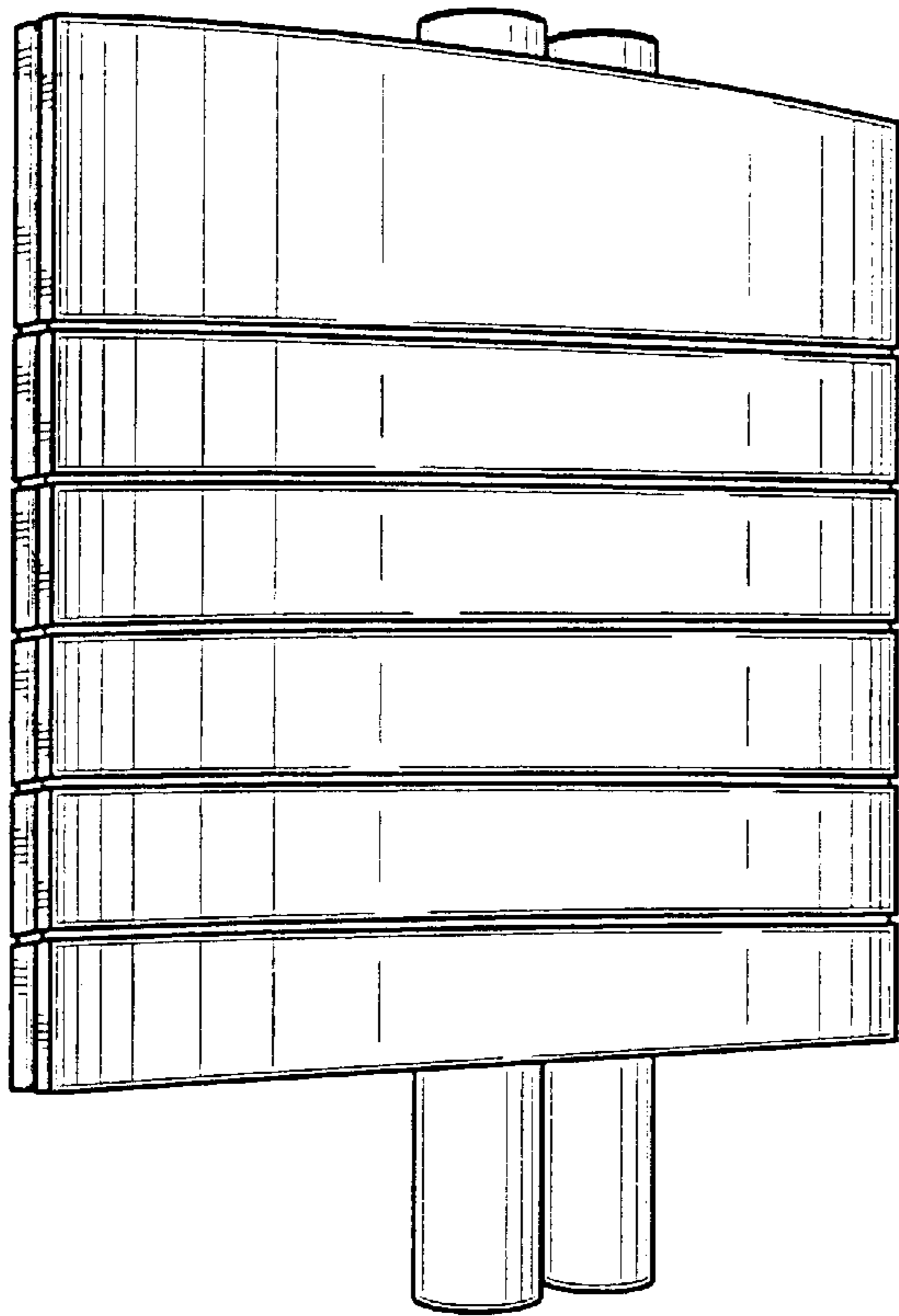
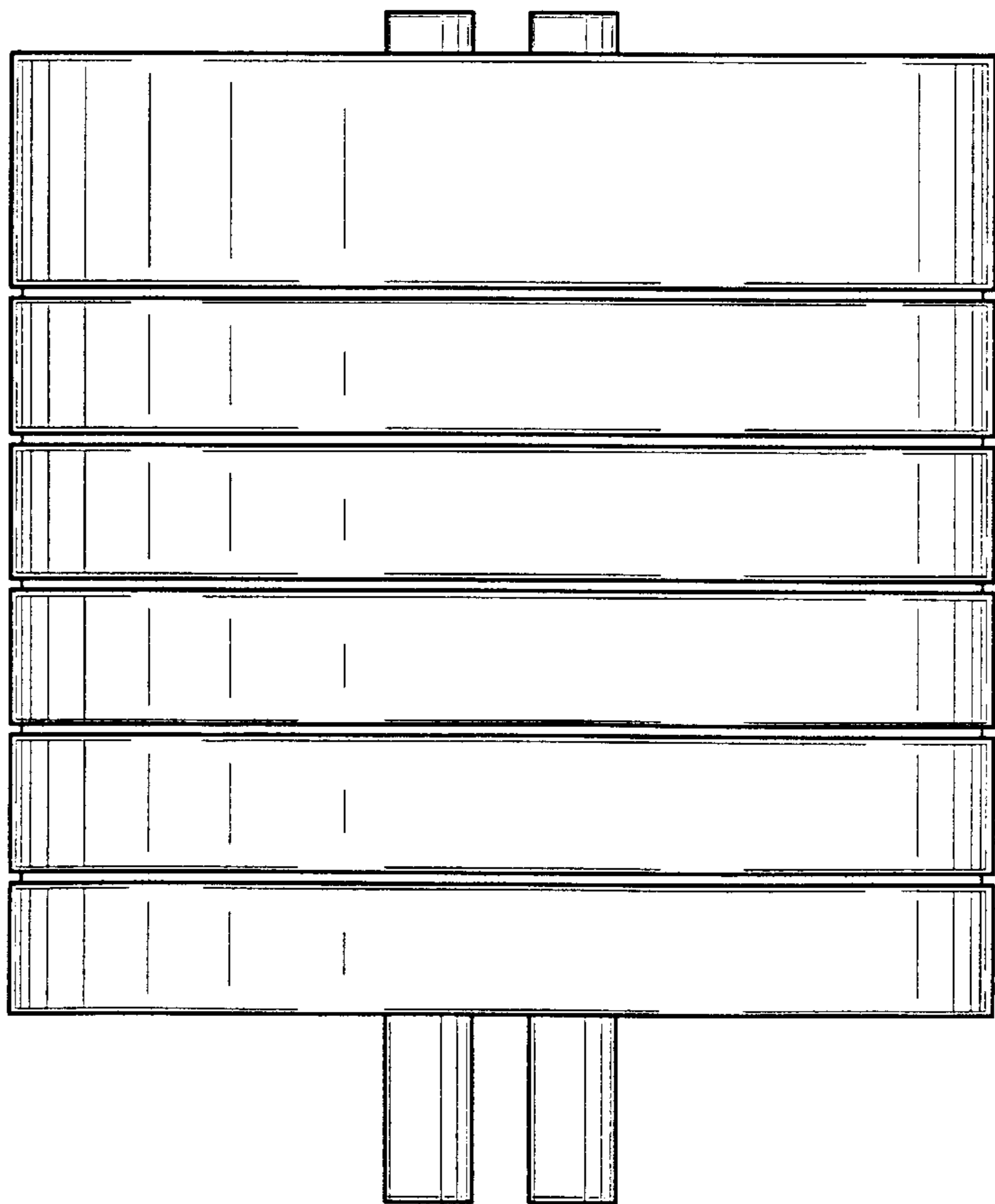

Figure - 11

Figure - 12



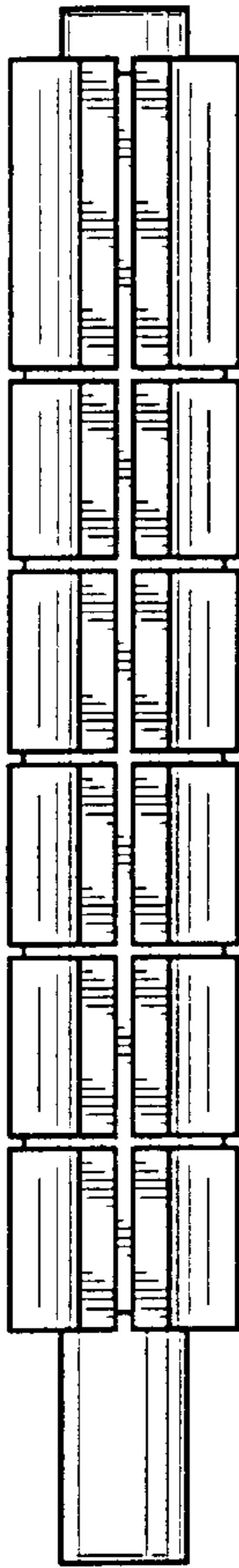

Figure - 13

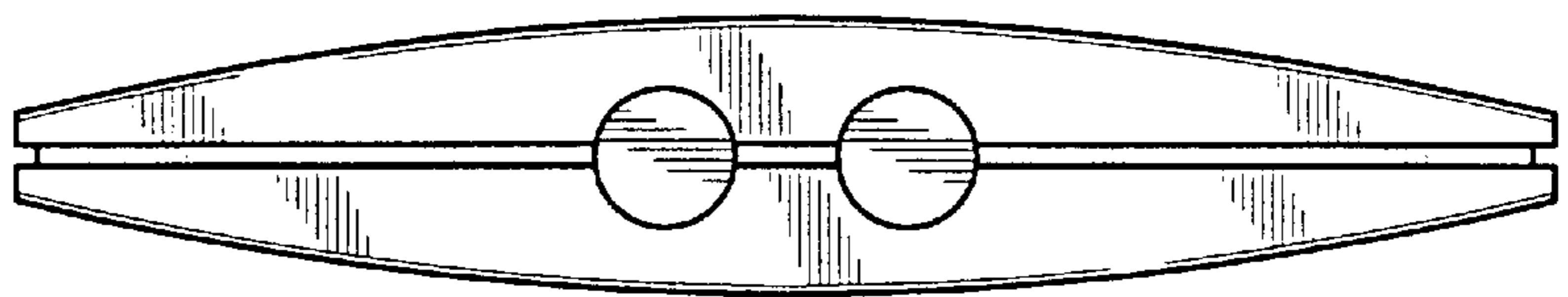

Figure - 14

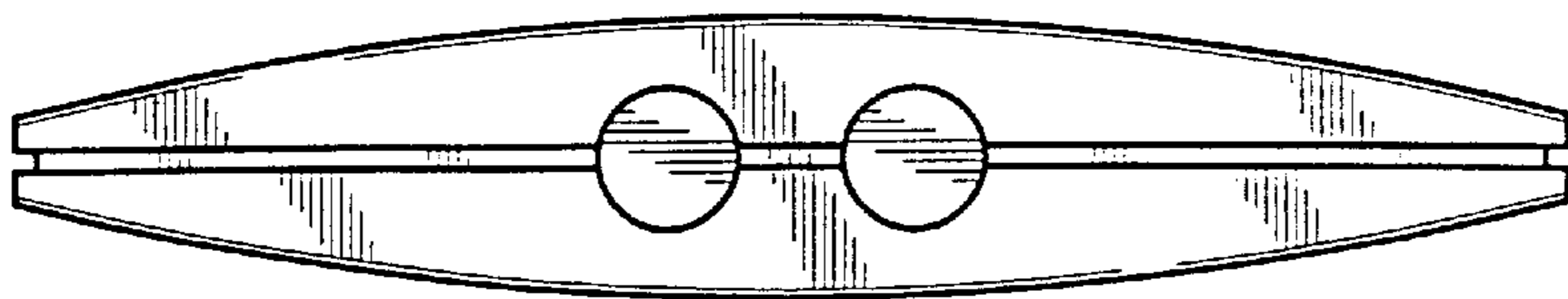

Figure - 15