



US00D449646B2

(12) **United States Design Patent**
Roewe

(10) **Patent No.:** **US D449,646 S**

(45) **Date of Patent:** **** Oct. 23, 2001**

(54) **SPORTS FOLDER**

(75) Inventor: **Timothy M. Roewe**, Washington, MO (US)

(73) Assignee: **DAC, Inc.**, Washington, MO (US)

(**) Term: **14 Years**

(21) Appl. No.: **29/116,085**

(22) Filed: **Dec. 27, 1999**

(51) **LOC (7) Cl.** **19-04**

(52) **U.S. Cl.** **D19/28; D19/26; D19/86**

(58) **Field of Search** D3/301, 303, 232, D3/900; D19/26, 27, 28, 32, 86, 33, 91; 70/68; 190/127, 901; 206/424, 810; 281/15.1, 19.1, 21.1, 27, 27.1-27.3, 29, 31, 35, 51; 402/79, 80 R

(56) **References Cited**

U.S. PATENT DOCUMENTS

D. 199,672	*	12/1964	Shelton	D3/201
D. 236,200	*	8/1975	Summers	D19/26
D. 257,263	*	10/1980	Dauvergne	D19/26
D. 303,989	*	10/1989	Korner	D19/26
D. 407,433	*	3/1999	Hodes	D19/27
D. 417,236	*	11/1999	Burrus	D19/28
2,305,361	*	12/1942	Tanner	281/15.1
4,828,289	*	5/1989	Korner	281/15.1

* cited by examiner

Primary Examiner—Martie K. Holtje

(74) *Attorney, Agent, or Firm*—Senniger, Powers, Leavitt & Roedel

(57) **CLAIM**

The ornamental design for a sports folder, as shown and described.

DESCRIPTION

FIG. 1 is a top plan view of a first embodiment of a sports folder of my design in a closed condition;

FIG. 2 is a bottom plan view thereof;
 FIG. 3 is a front elevational view thereof;
 FIG. 4 is an enlarged rear elevational view thereof;
 FIG. 5 is an enlarged left side elevational view thereof;
 FIG. 6 is an enlarged right side elevational view thereof;
 FIG. 7 is a top plan view of the sports folder of the first embodiment in an open condition;
 FIG. 8 is a top plan view of a second embodiment of a sports folder of my design in a closed condition;
 FIG. 9 is a bottom plan view thereof;
 FIG. 10 is an enlarged front elevational view thereof;
 FIG. 11 is an enlarged rear elevational view thereof;
 FIG. 12 is an enlarged left side elevational view thereof;
 FIG. 13 is an enlarged right side elevational view thereof;
 FIG. 14 is a top plan view of the sports folder of the second embodiment in an open condition;
 FIG. 15 is a top plan view of a third embodiment of a sports folder of my design in a closed condition;
 FIG. 16 is a bottom plan view thereof;
 FIG. 17 is a front elevational view thereof;
 FIG. 18 is a rear elevational view thereof;
 FIG. 19 is a left side elevational view thereof, the right side view being a mirror image of the left side view;
 FIG. 20 is a top plan view of the sports folder of the third embodiment in an open condition;
 FIG. 21 is a top plan view of a fourth embodiment of a sports folder of my design in a closed condition;
 FIG. 22 is a bottom plan view thereof;
 FIG. 23 is a front elevational view thereof;
 FIG. 24 is a rear elevational view thereof;
 FIG. 25 is a left side elevational view thereof;
 FIG. 26 is a right side elevational view thereof;
 FIG. 27 is a top plan view of the sports folder of the fourth embodiment in an open condition;
 FIG. 28 is a top plan view of a fifth embodiment of a sports folder of my design in a closed condition;
 FIG. 29 is a bottom plan view thereof;
 FIG. 30 is a front elevational view thereof;
 FIG. 31 is a rear elevational view thereof;
 FIG. 32 is a left side elevational view thereof;
 FIG. 33 is a right side elevational view thereof;
 FIG. 34 is a top plan view of the sports folder of the fifth embodiment in an open condition;

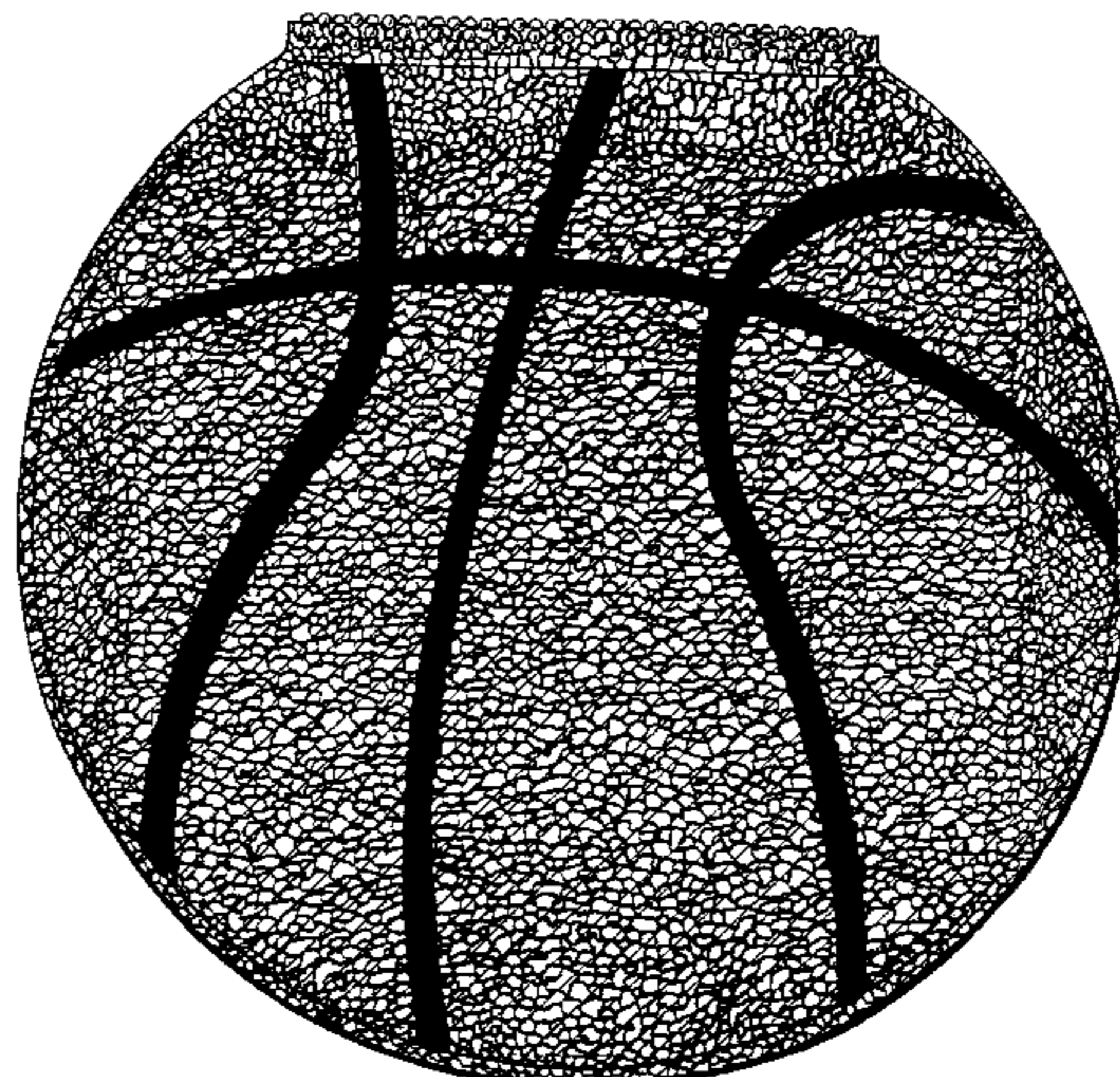

FIG. 35 is a top plan view of a sixth embodiment of a sports folder of my design in a closed condition;
FIG. 36 is a bottom plan view thereof;
FIG. 37 is a front elevational view thereof;
FIG. 38 is a rear elevational view thereof;
FIG. 39 is a left side elevational view thereof, the right side view being a mirror image of the left side view;
FIG. 40 is a top plan view of the sports folder of the sixth embodiment in an open condition;
FIG. 41 is a top plan view of a seventh embodiment of a sports folder of my design in a closed condition;
FIG. 42 is a bottom plan view thereof;
FIG. 43 is a front elevational view thereof;
FIG. 44 is a rear elevational view thereof;
FIG. 45 is a left side elevational view thereof, the right side view being a mirror image of the left side view;
FIG. 46 is a top plan view of the sports folder of the seventh embodiment in an open condition;
FIG. 47 is a top plan view of an eighth embodiment of a sports folder in a closed condition;
FIG. 48 is a bottom plan view thereof;
FIG. 49 is a front elevational view thereof;
FIG. 50 is a rear elevational view thereof;

FIG. 51 is a left side elevational view thereof;
FIG. 52 is a right side elevational view thereof;
FIG. 53 is a top plan view of the sports folder of the eighth embodiment in an open condition;
FIG. 54 is a top plan view of a ninth embodiment of a sports folder of my design in a closed condition;
FIG. 55 is a bottom plan view thereof;
FIG. 56 is a front elevational view thereof;
FIG. 57 is a rear elevational view thereof;
FIG. 58 is a left side elevational view thereof, the right side view being a mirror image of the left side view;
FIG. 59 is a top plan view of the sports folder of the ninth embodiment in an open condition;
FIG. 60 is a top plan view of a tenth embodiment of a sports folder of my design in a closed condition; and,
FIG. 61 is a bottom plan view thereof, the remaining views being identical to FIGS. 56–59.

The note pad depicted by broken lines in the figures has been shown for illustrative purposes only and forms no part of the claimed design.

1 Claim, 28 Drawing Sheets

FIG. 1

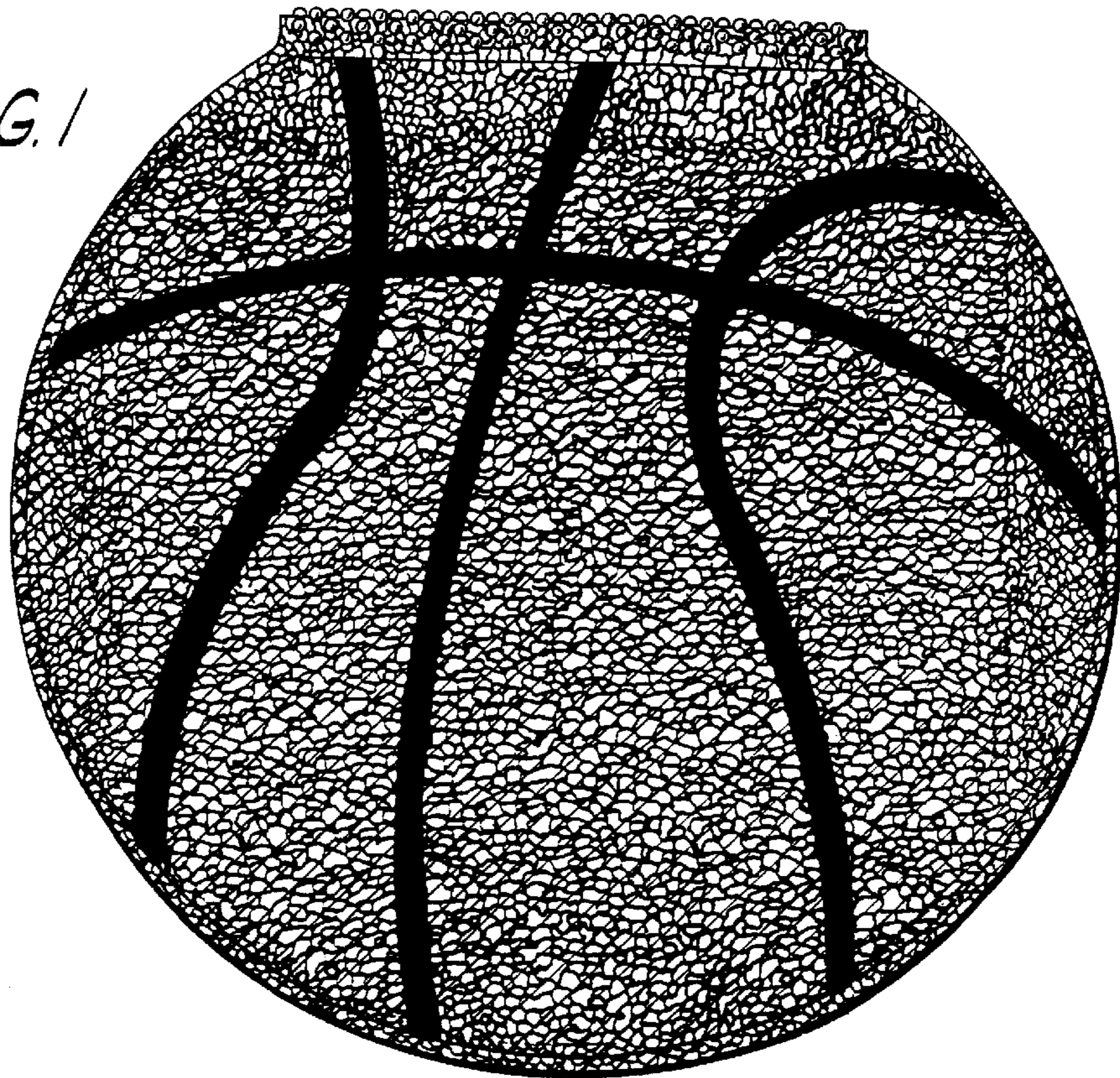

FIG. 2

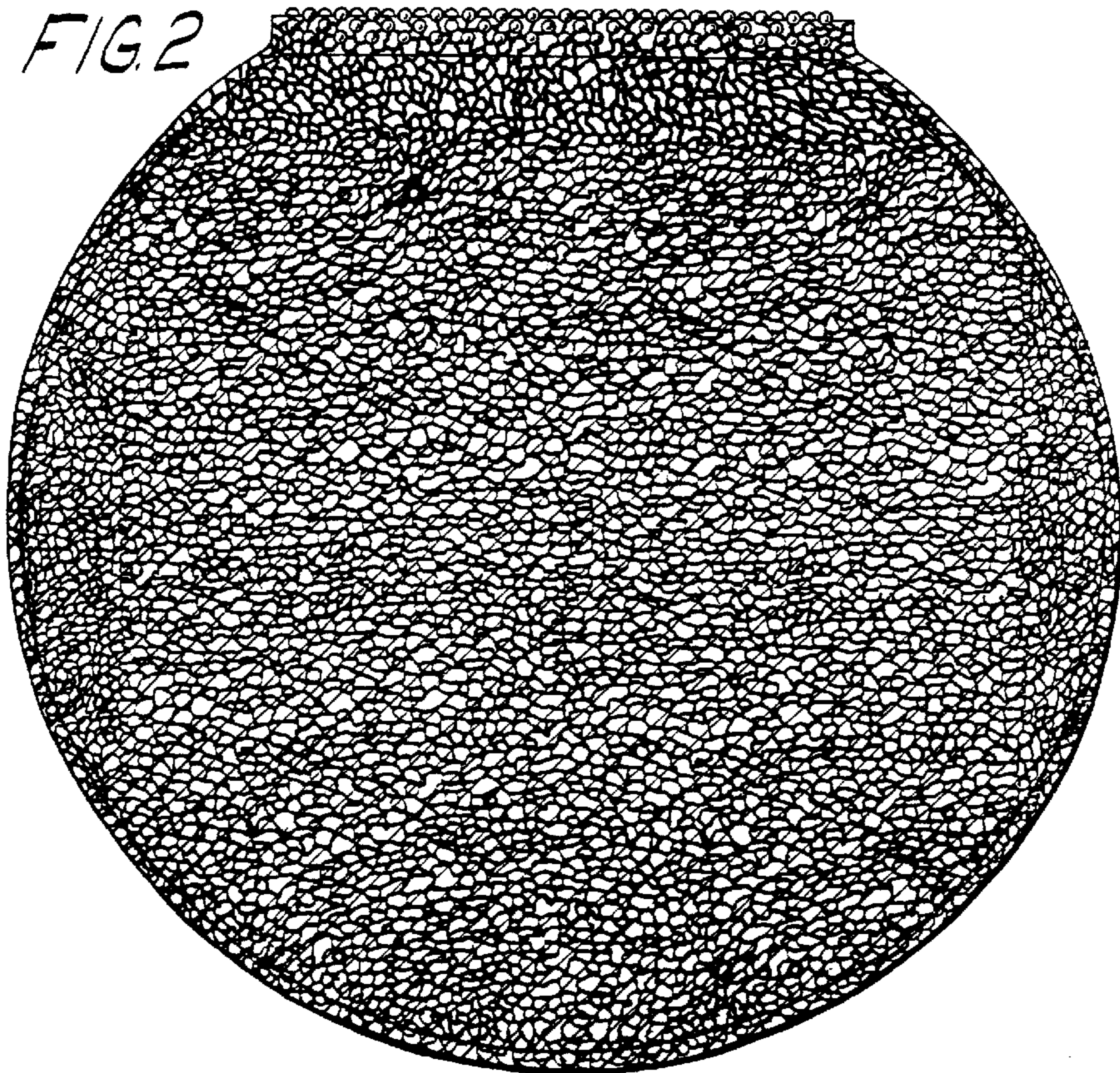

FIG. 3

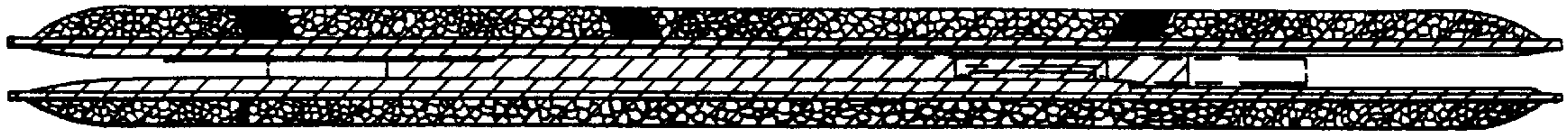

FIG. 4



FIG. 5



FIG. 6

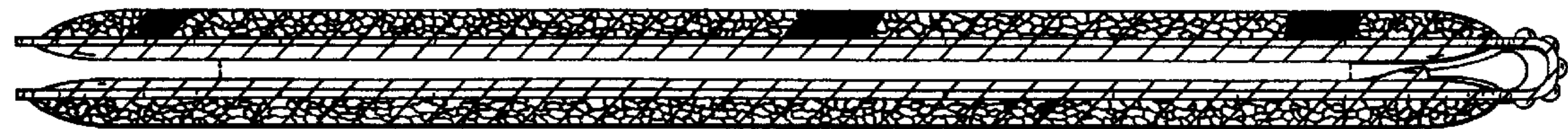

FIG. 7

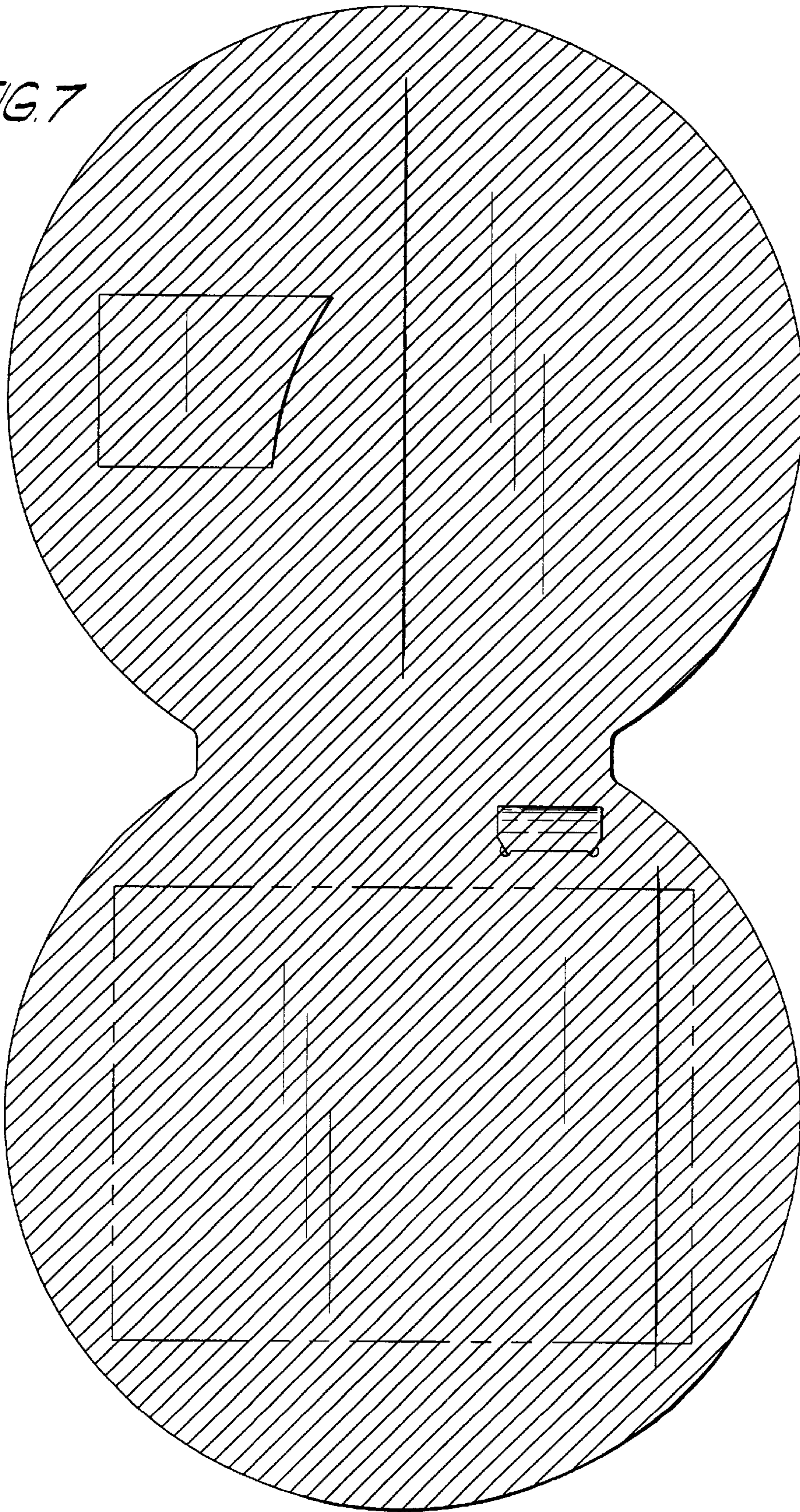

FIG. 8

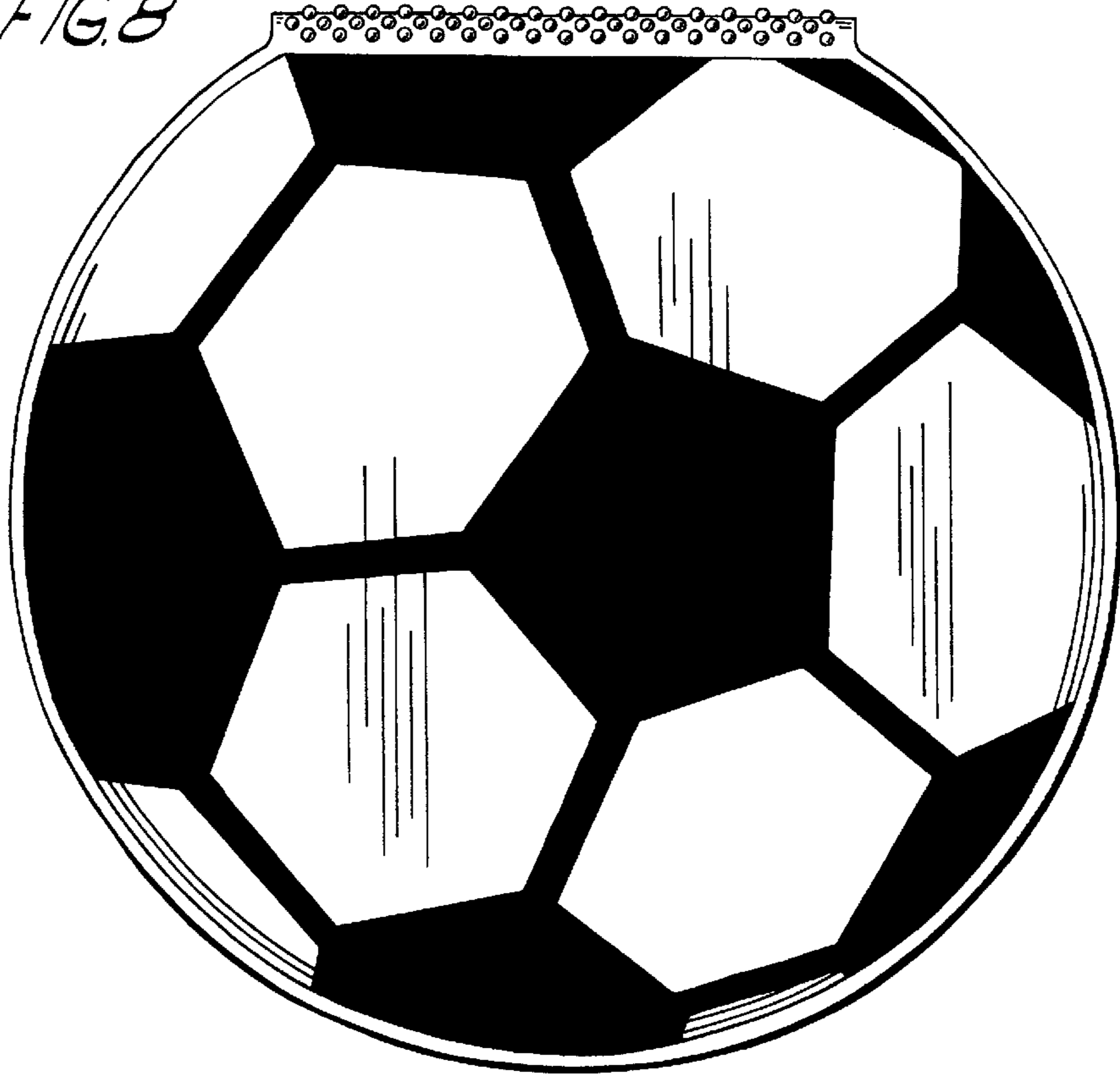

FIG. 9

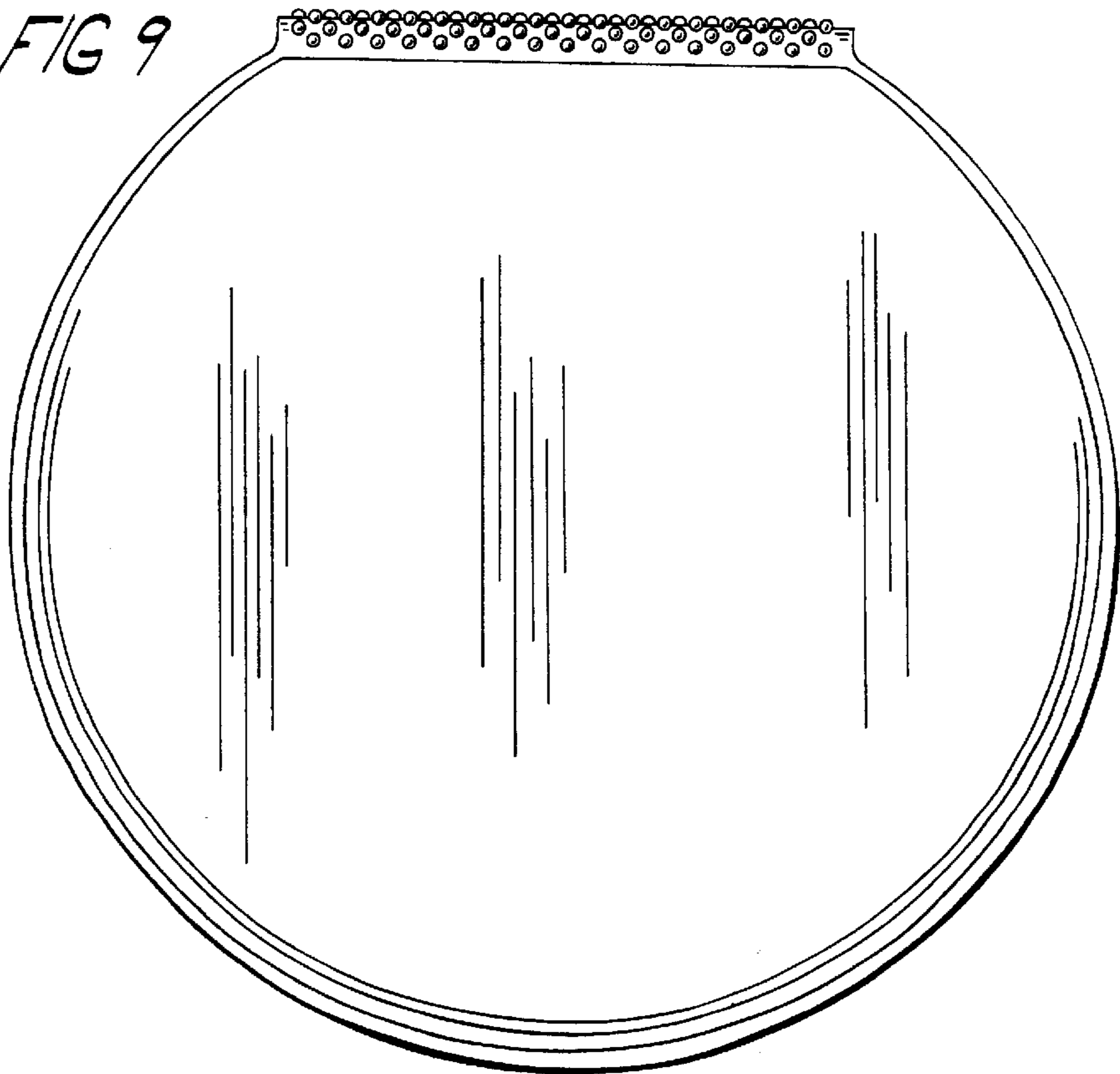

FIG. 10

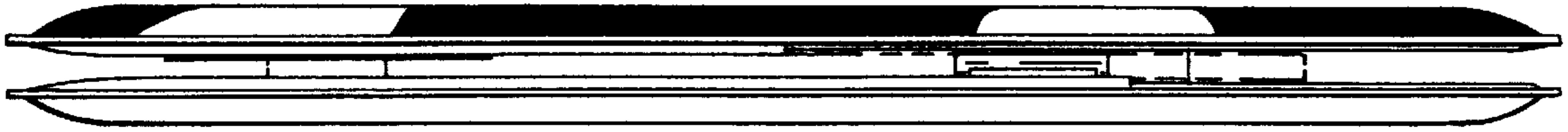

FIG. 11

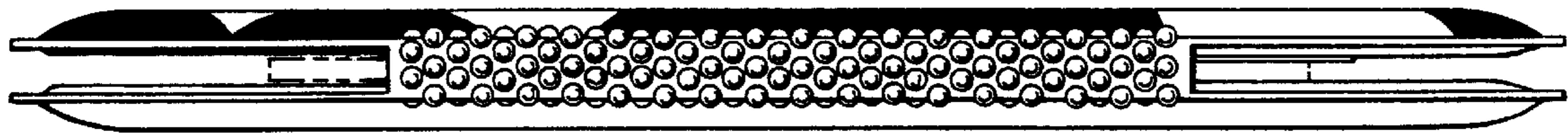

FIG. 12



FIG. 13

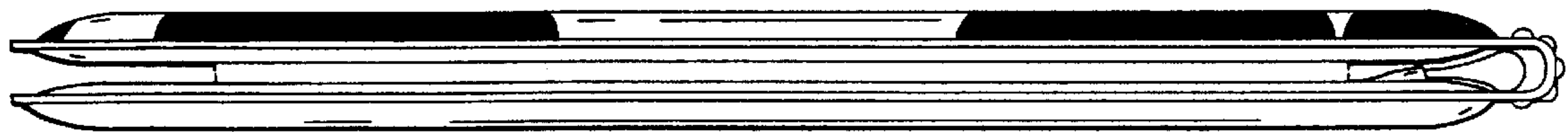

FIG. 14

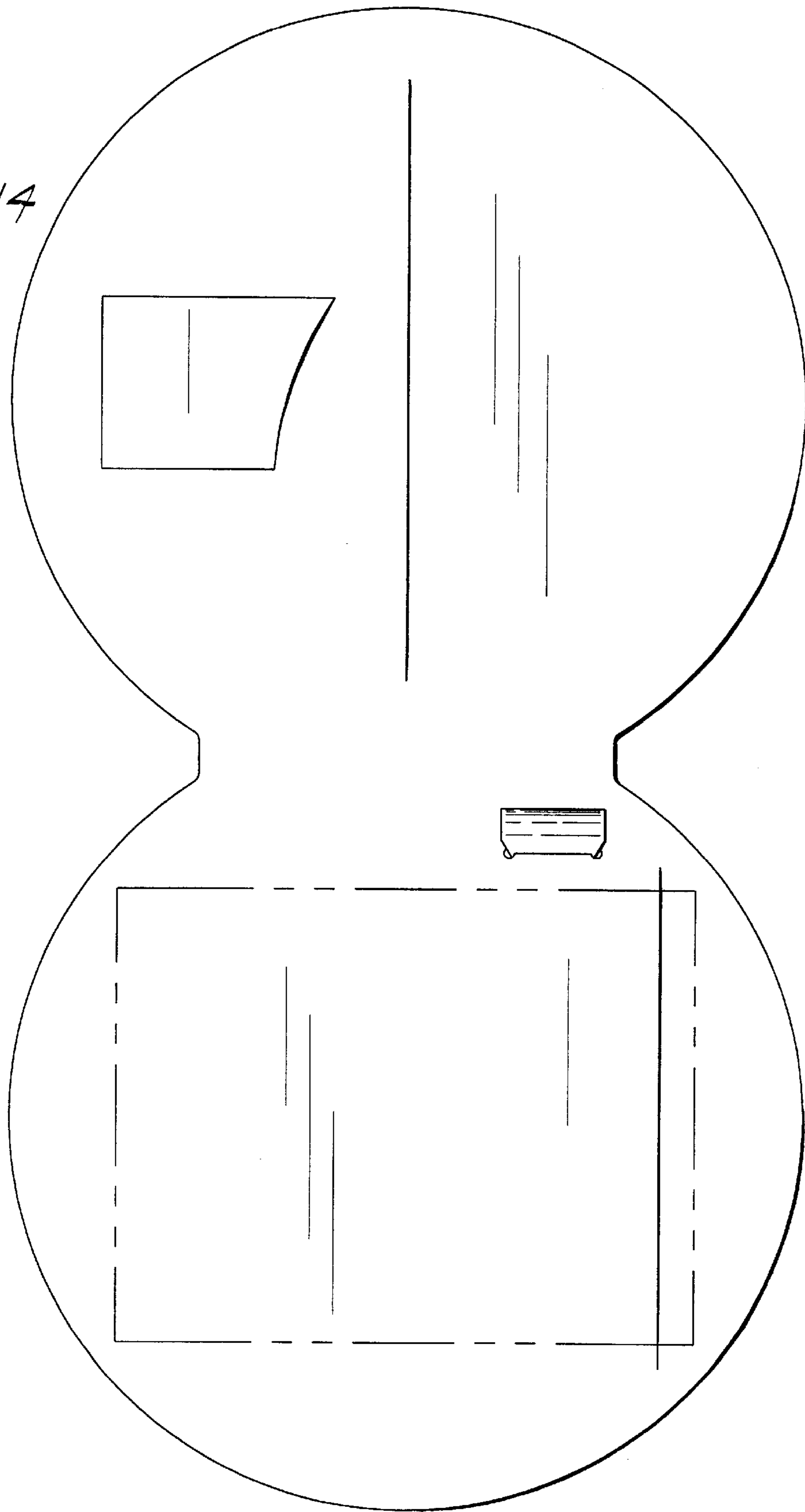

FIG. 15

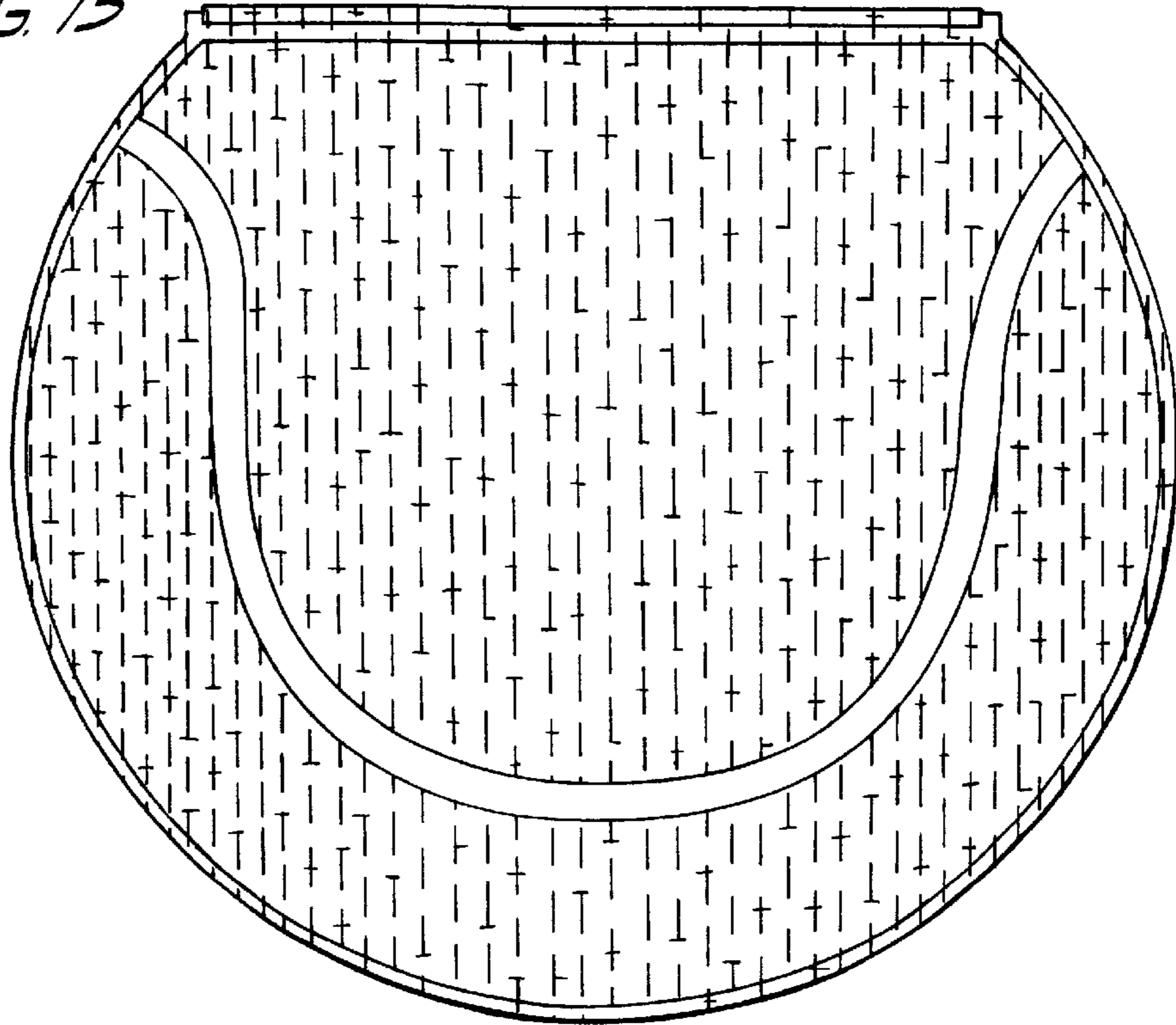

FIG. 16

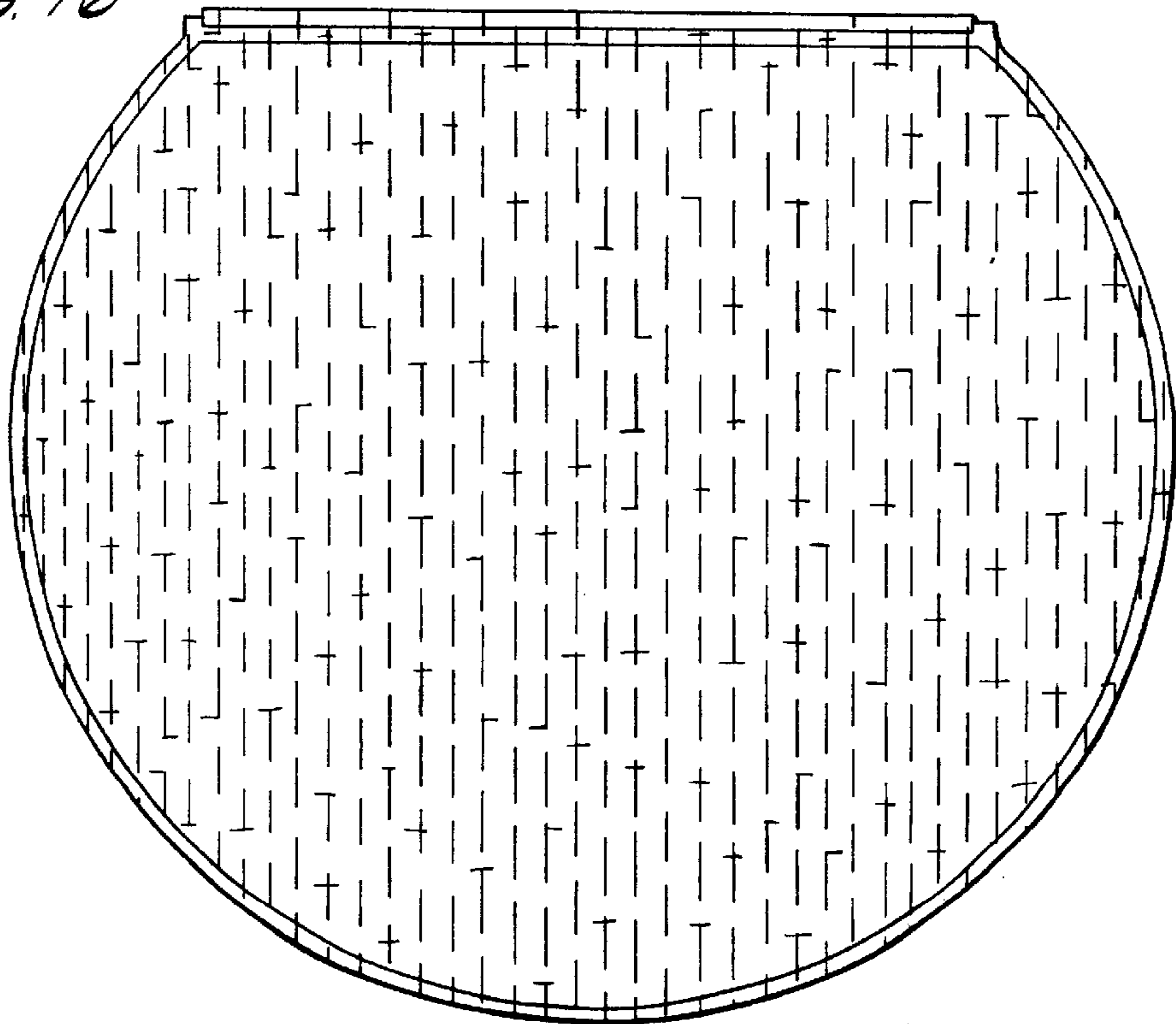

FIG. 17

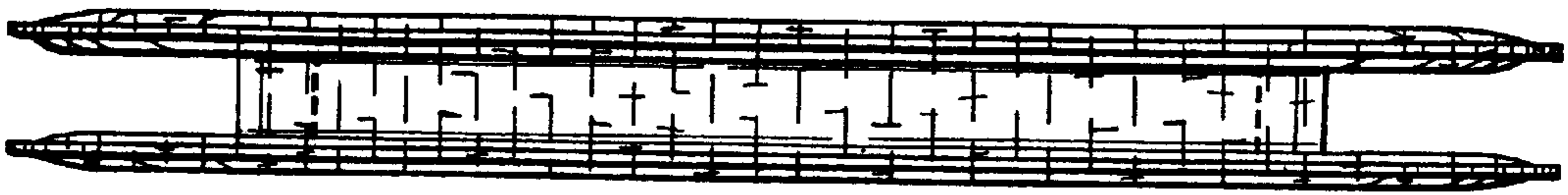

FIG. 18

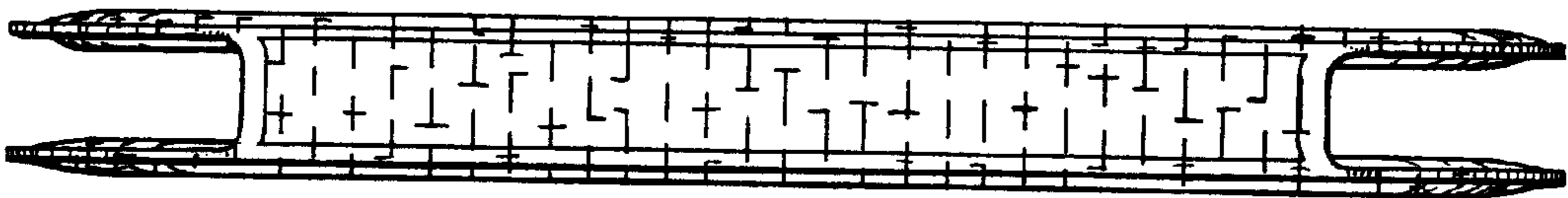

FIG. 19

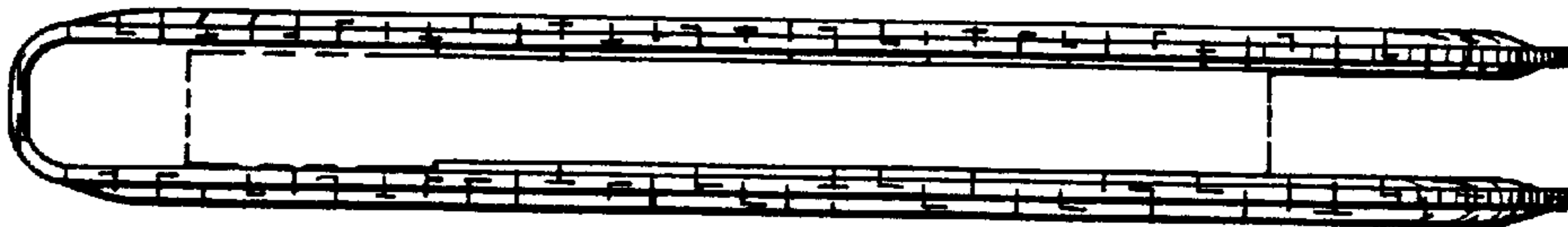

FIG. 20

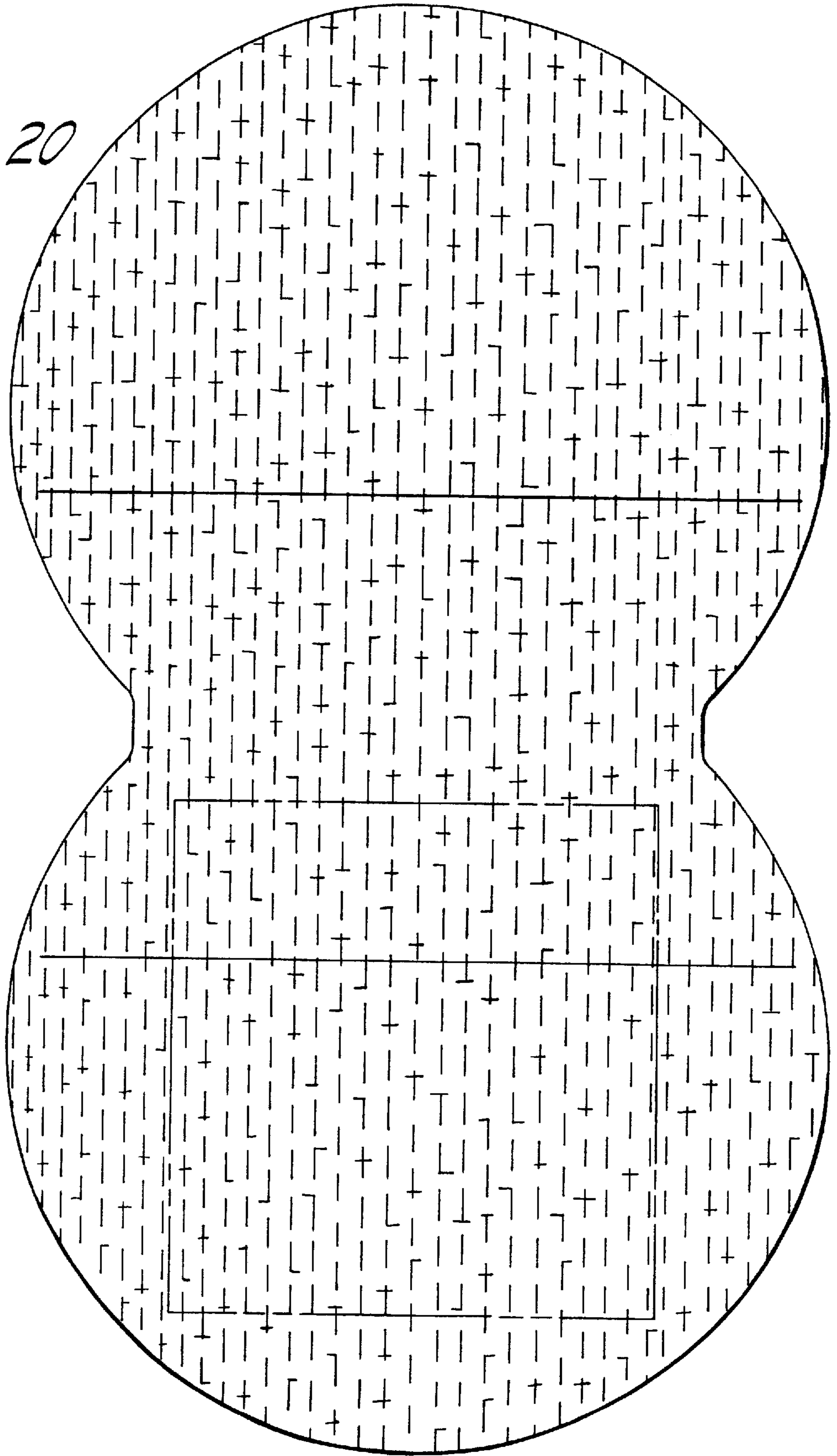

FIG. 21

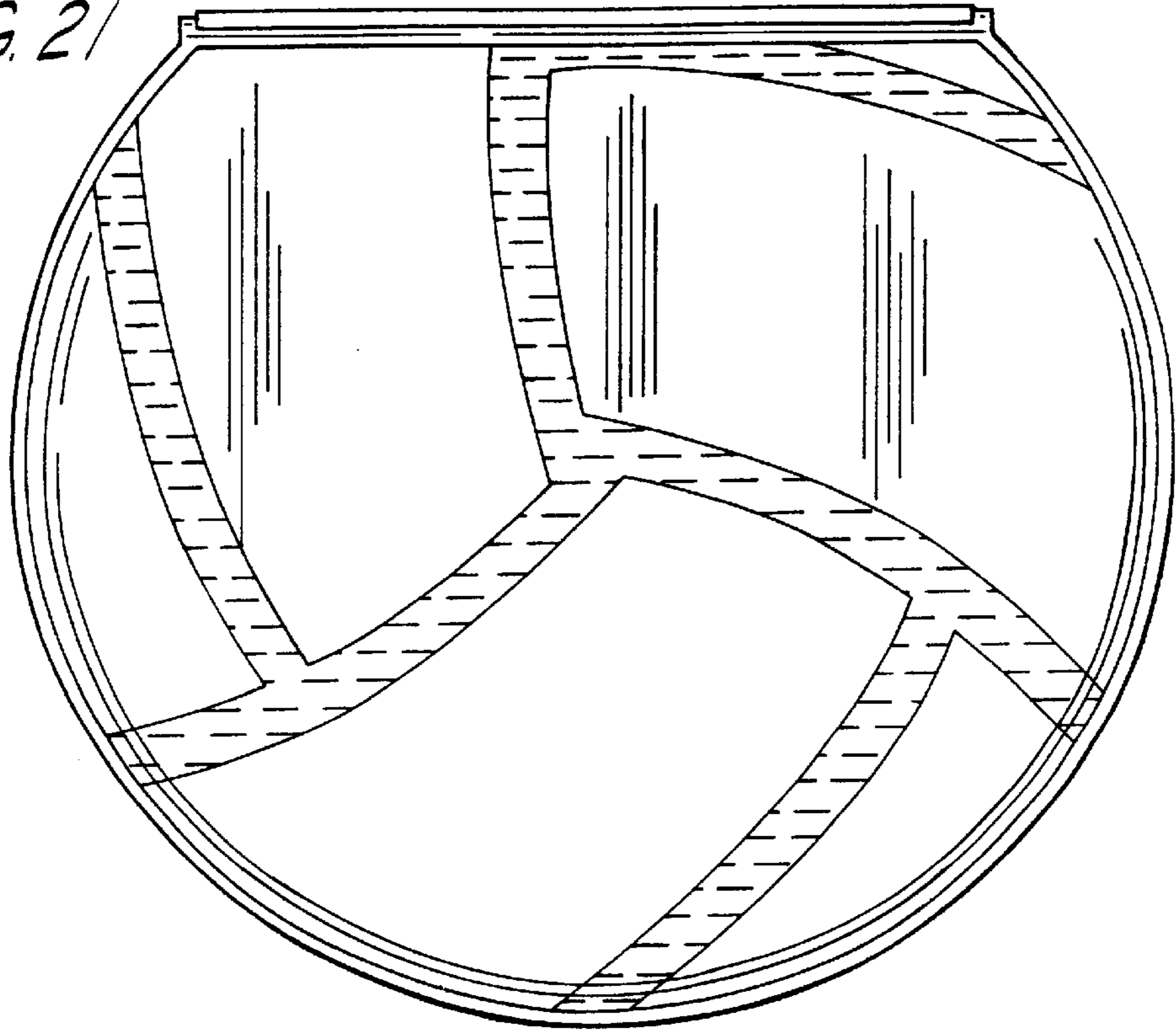

FIG. 22

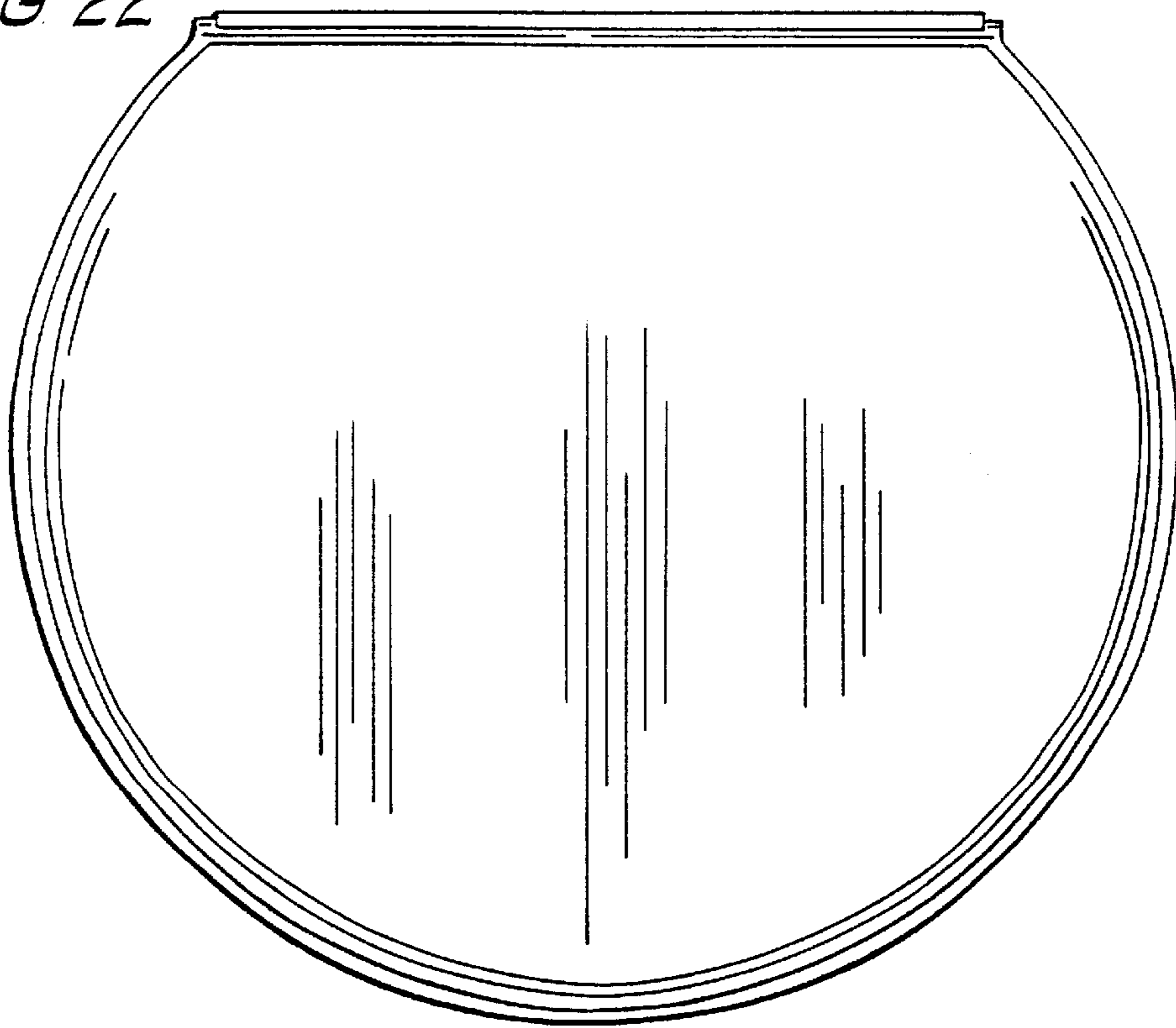

FIG. 23

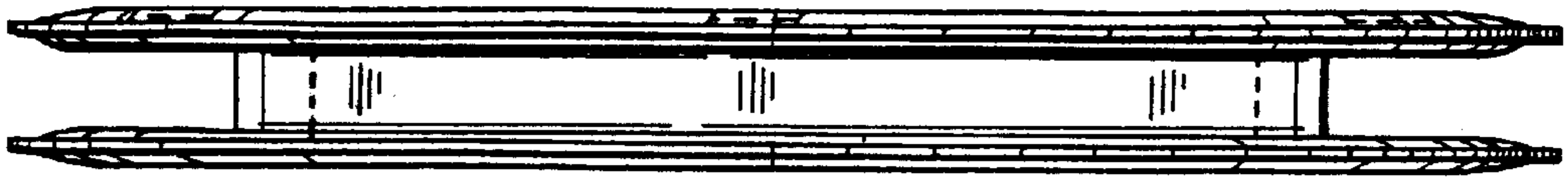

FIG. 24

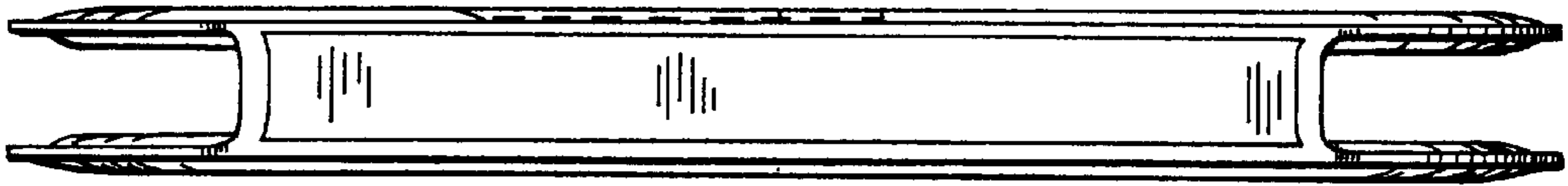

FIG. 25

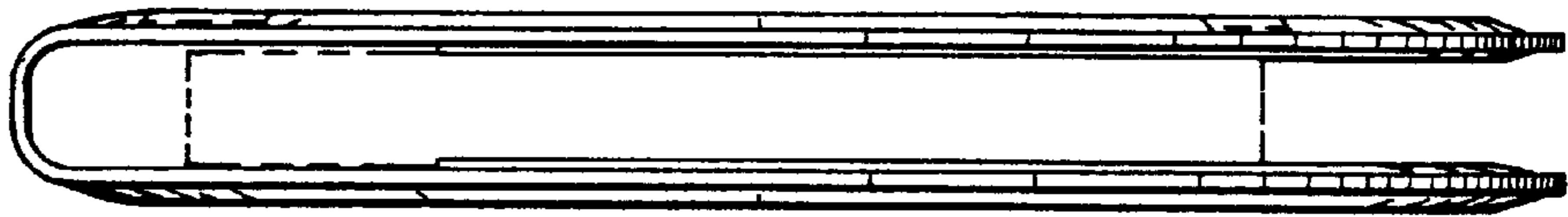

FIG. 26

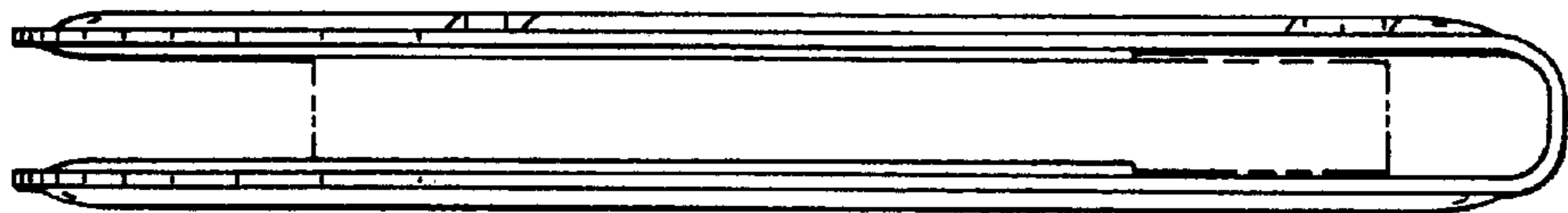

FIG. 27

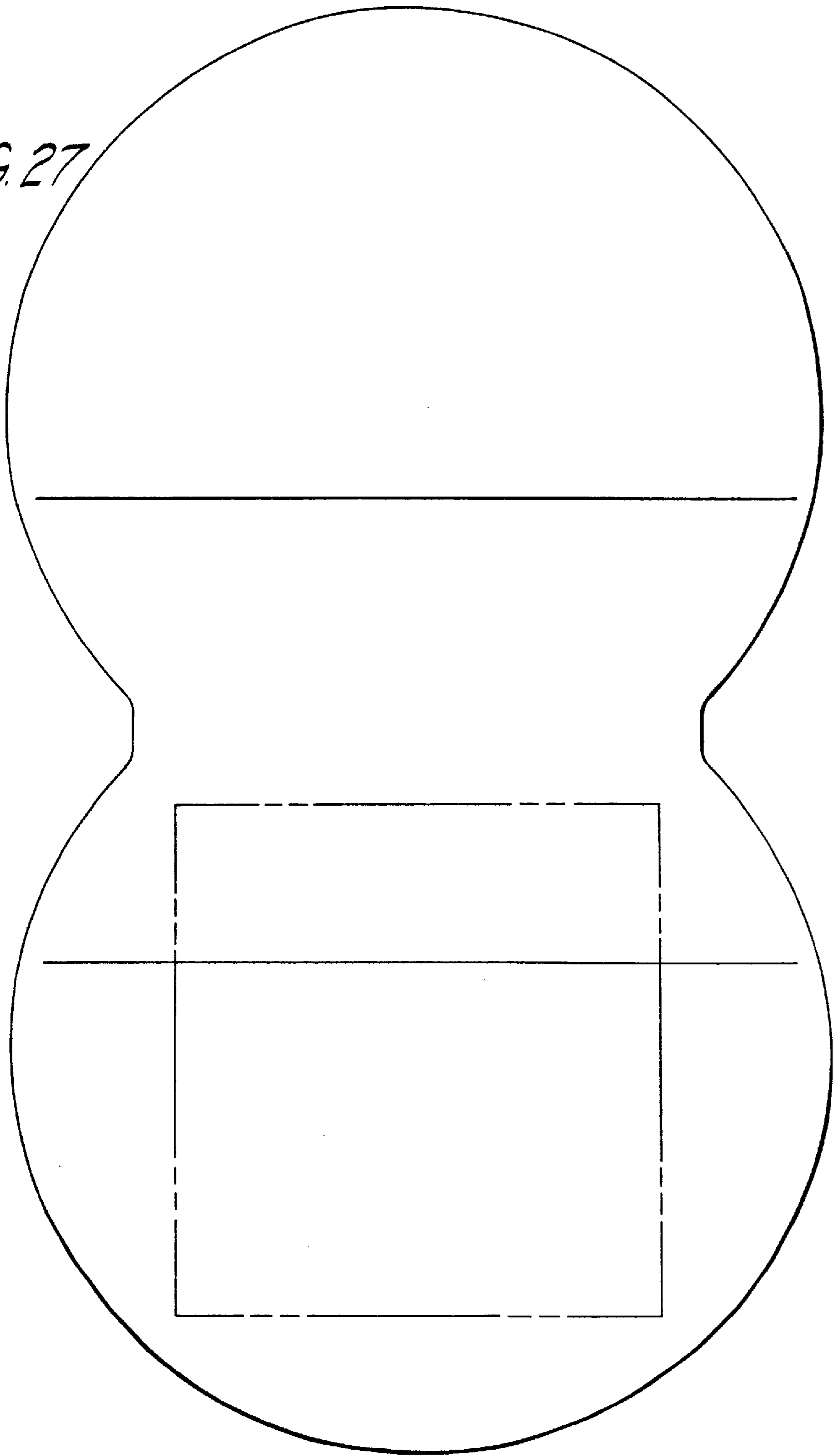

FIG. 28

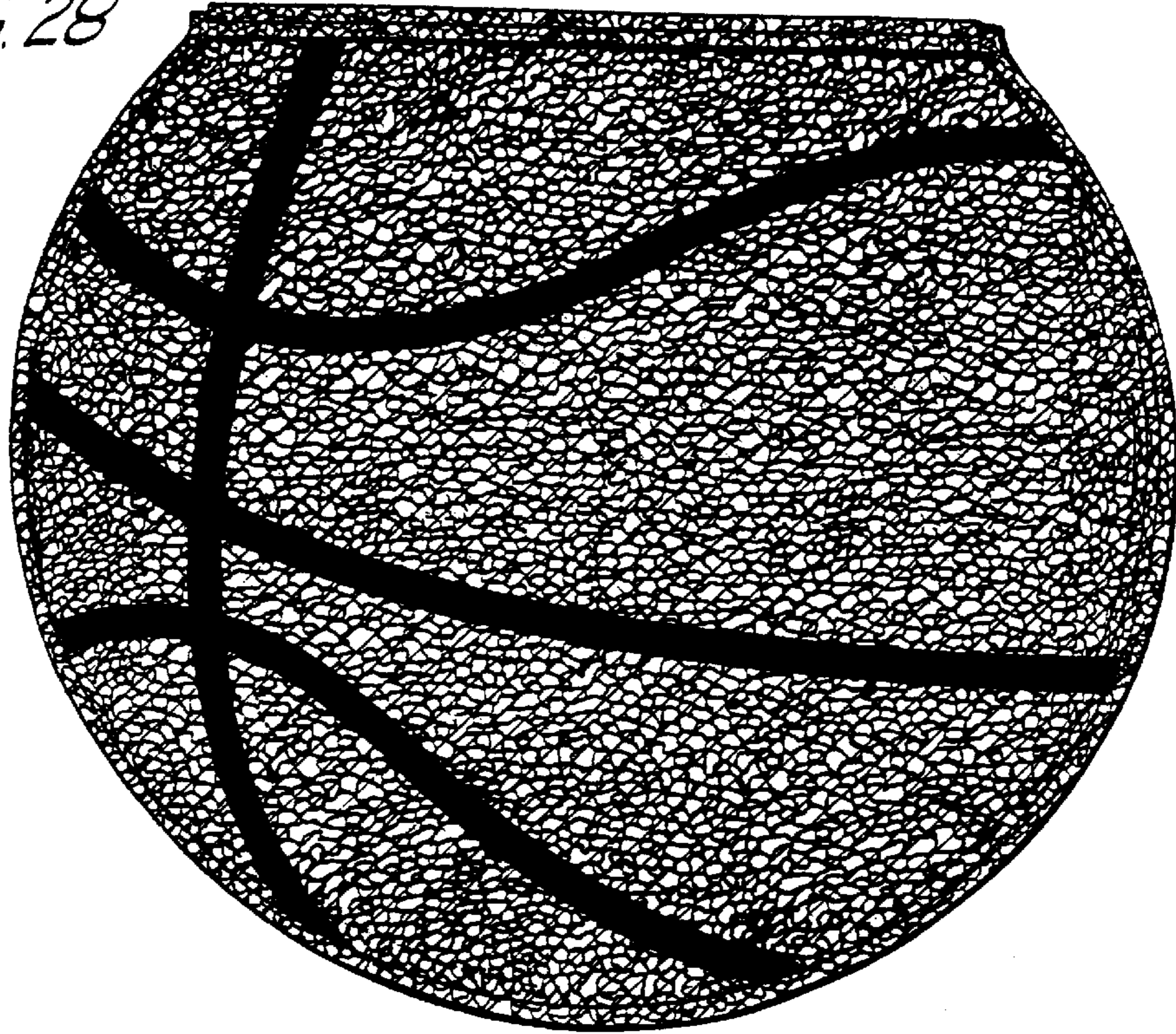

FIG. 29

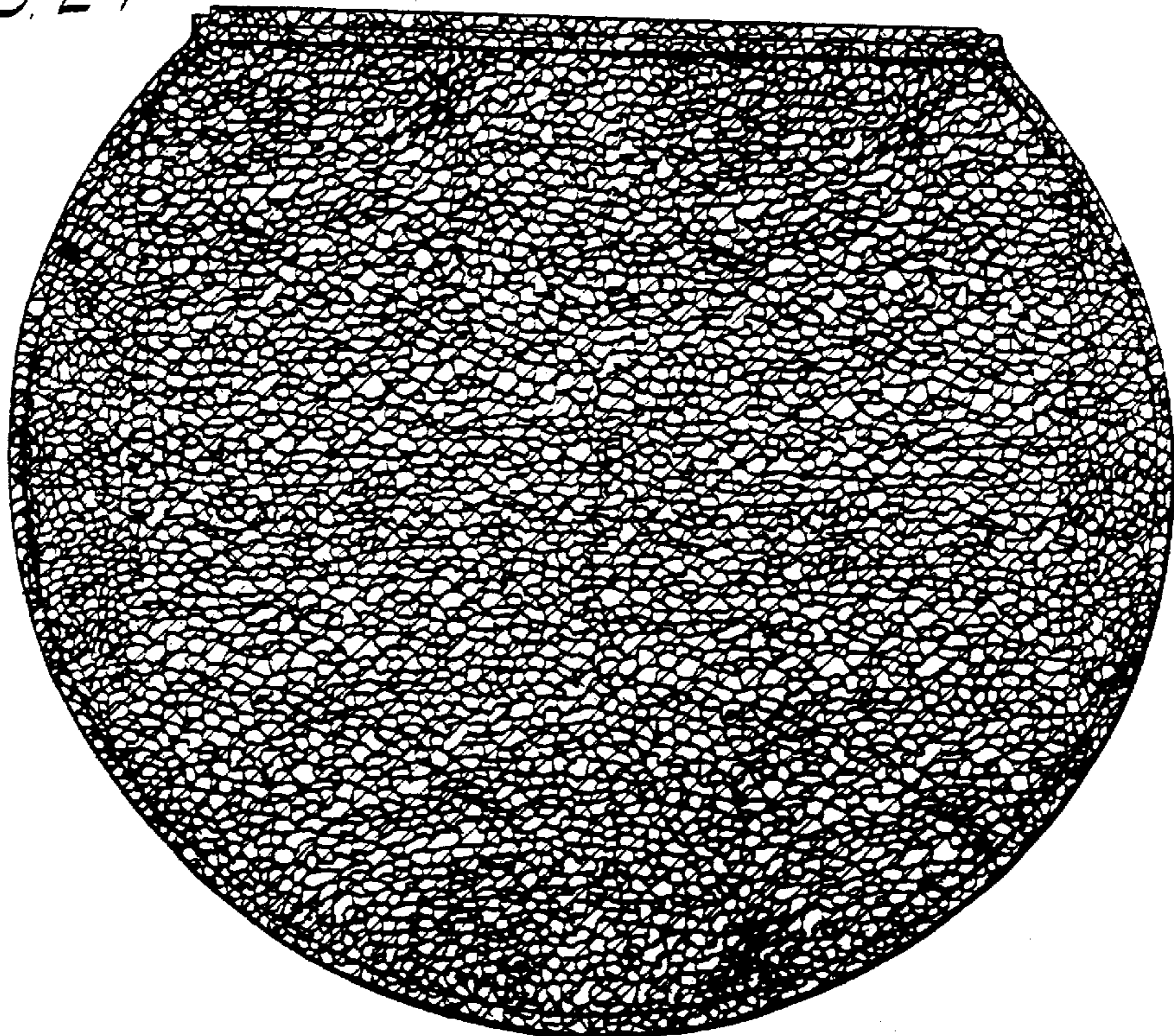

FIG. 30



FIG. 31

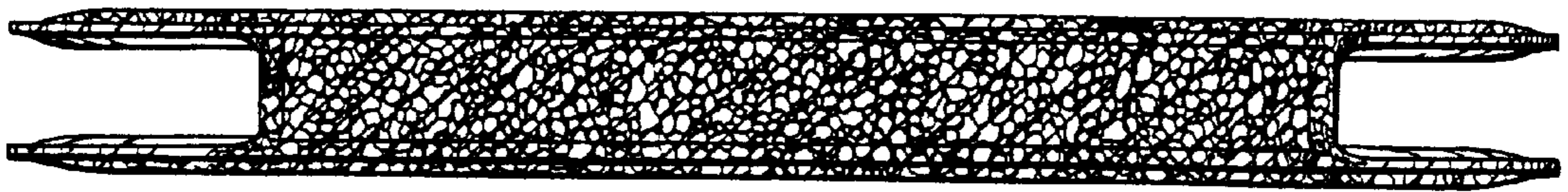

FIG. 32

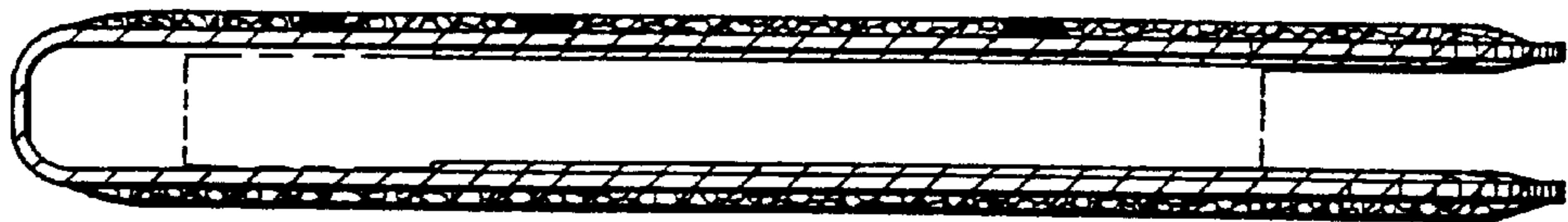

FIG. 33

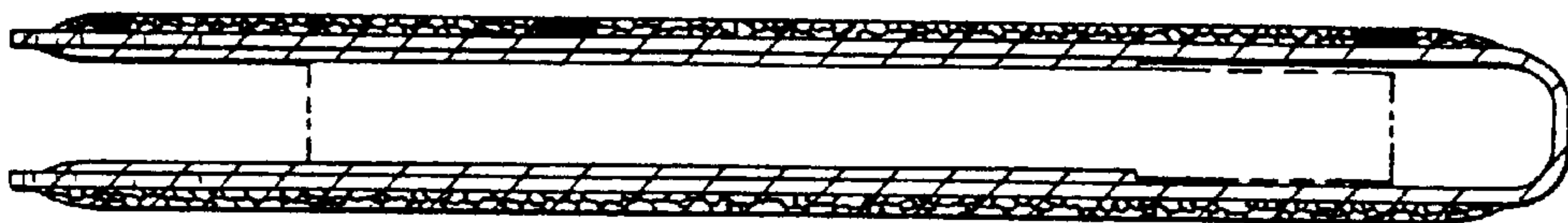

FIG 34

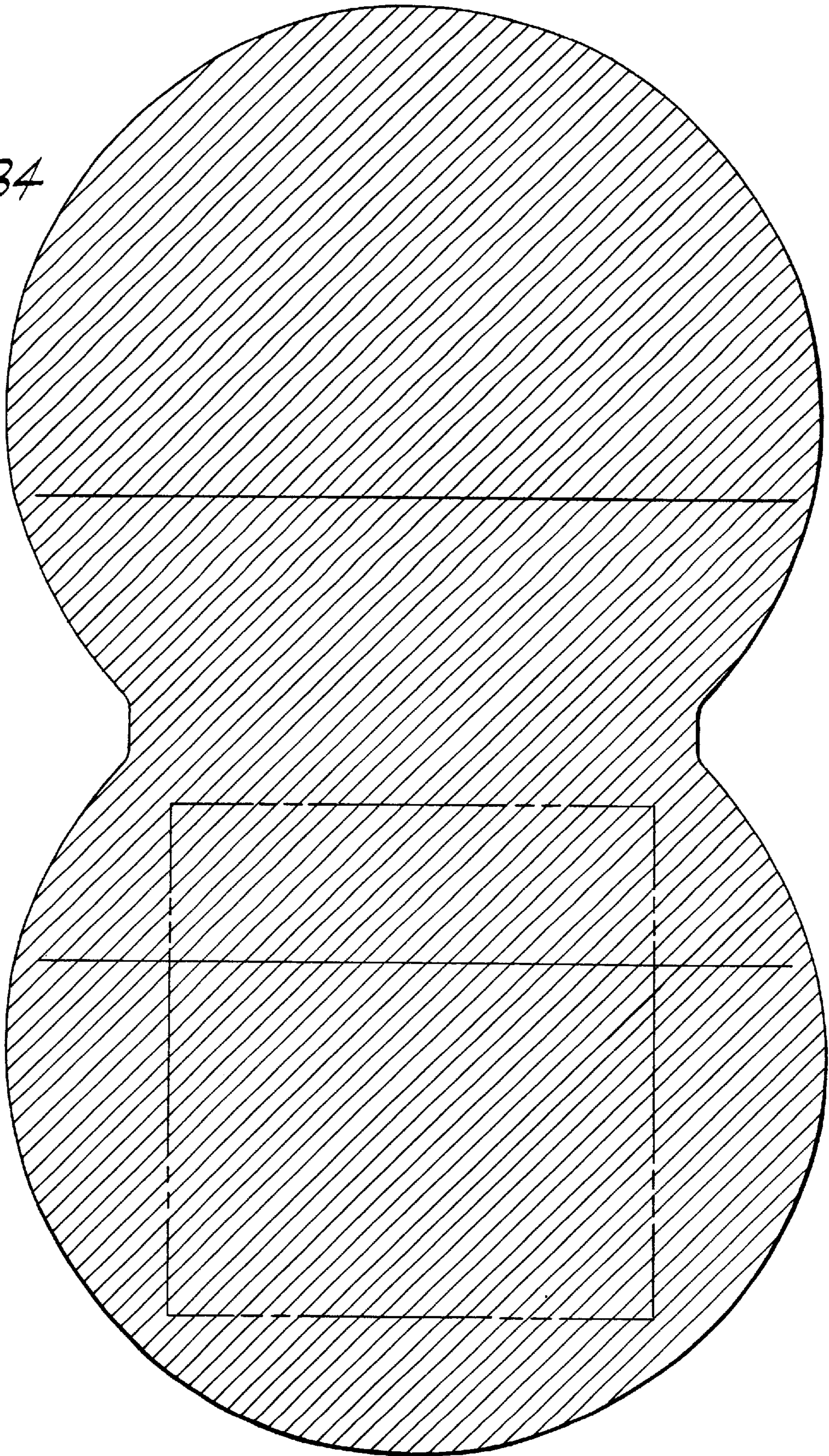

FIG. 35

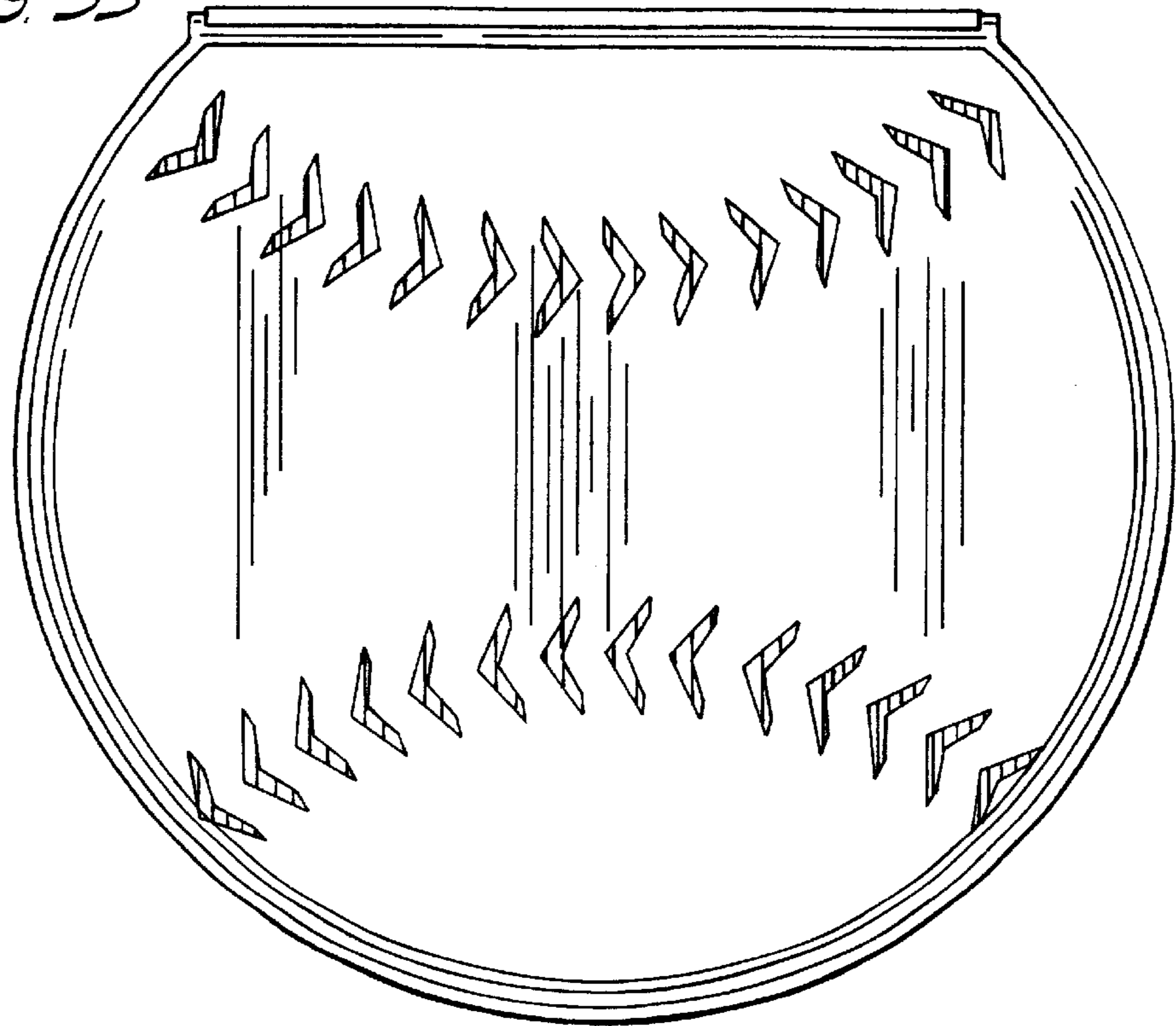

FIG. 36

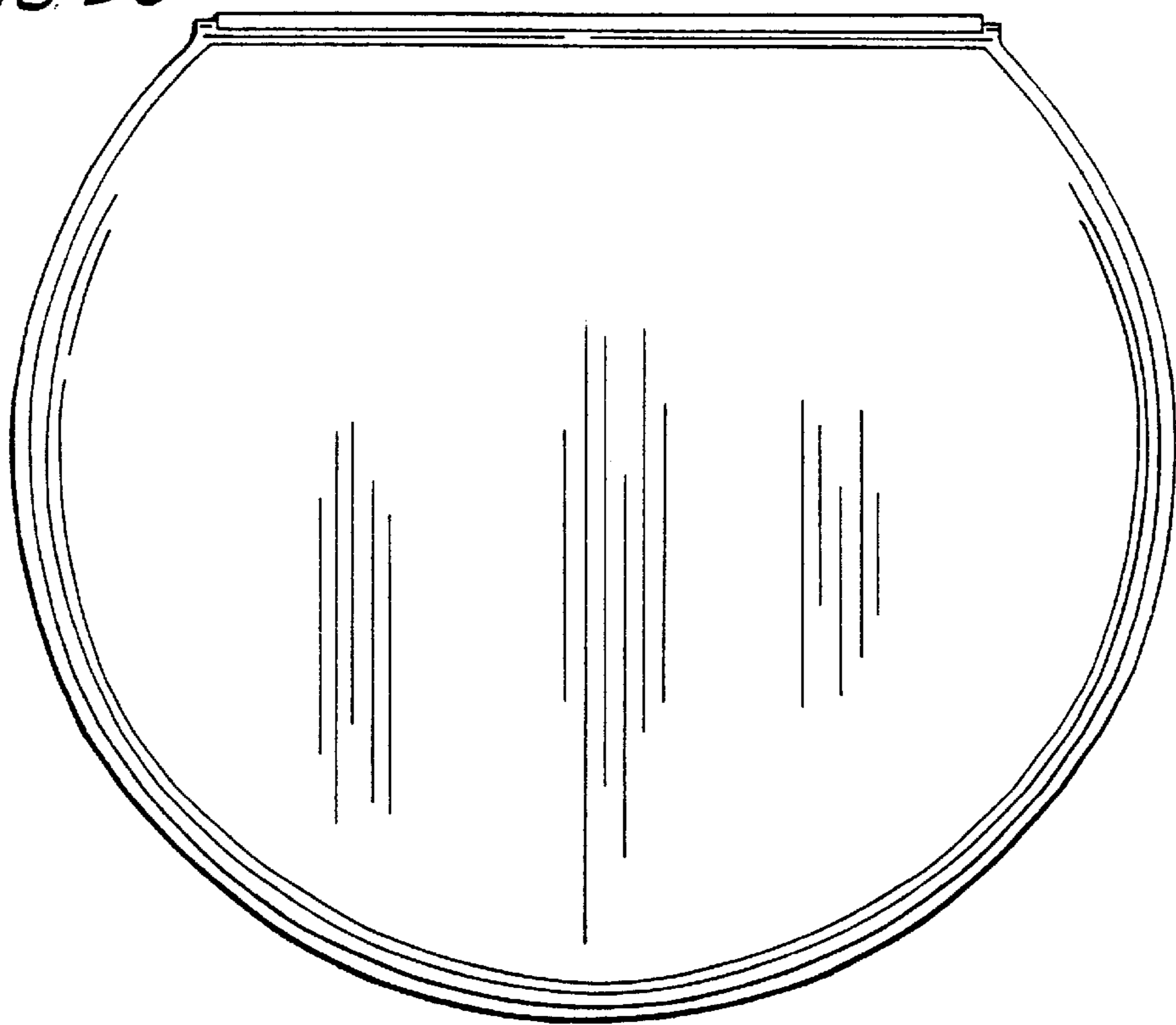

FIG. 37

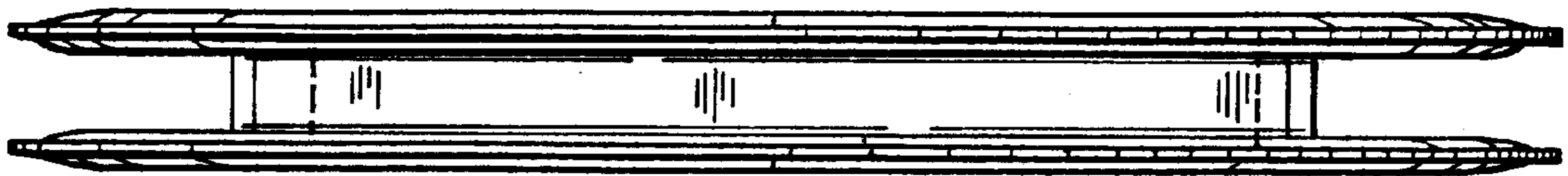

FIG. 38

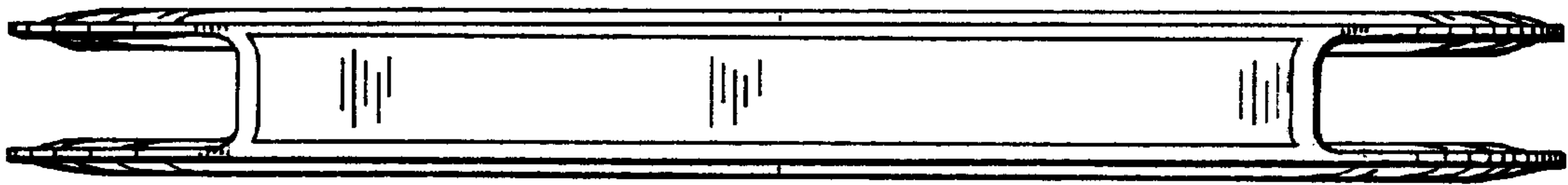

FIG. 39

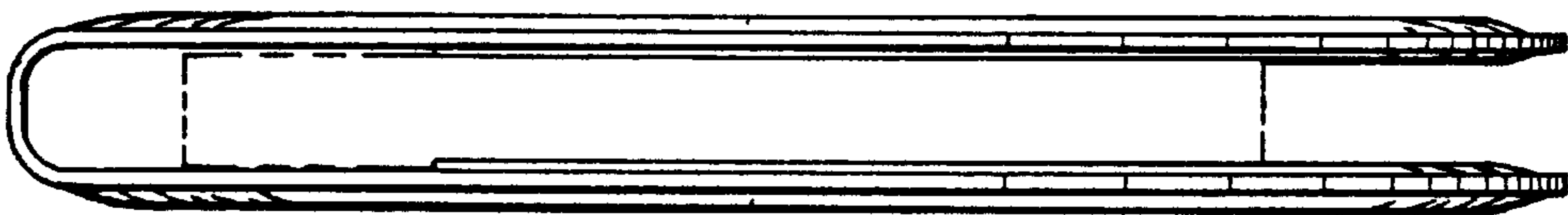

FIG. 40

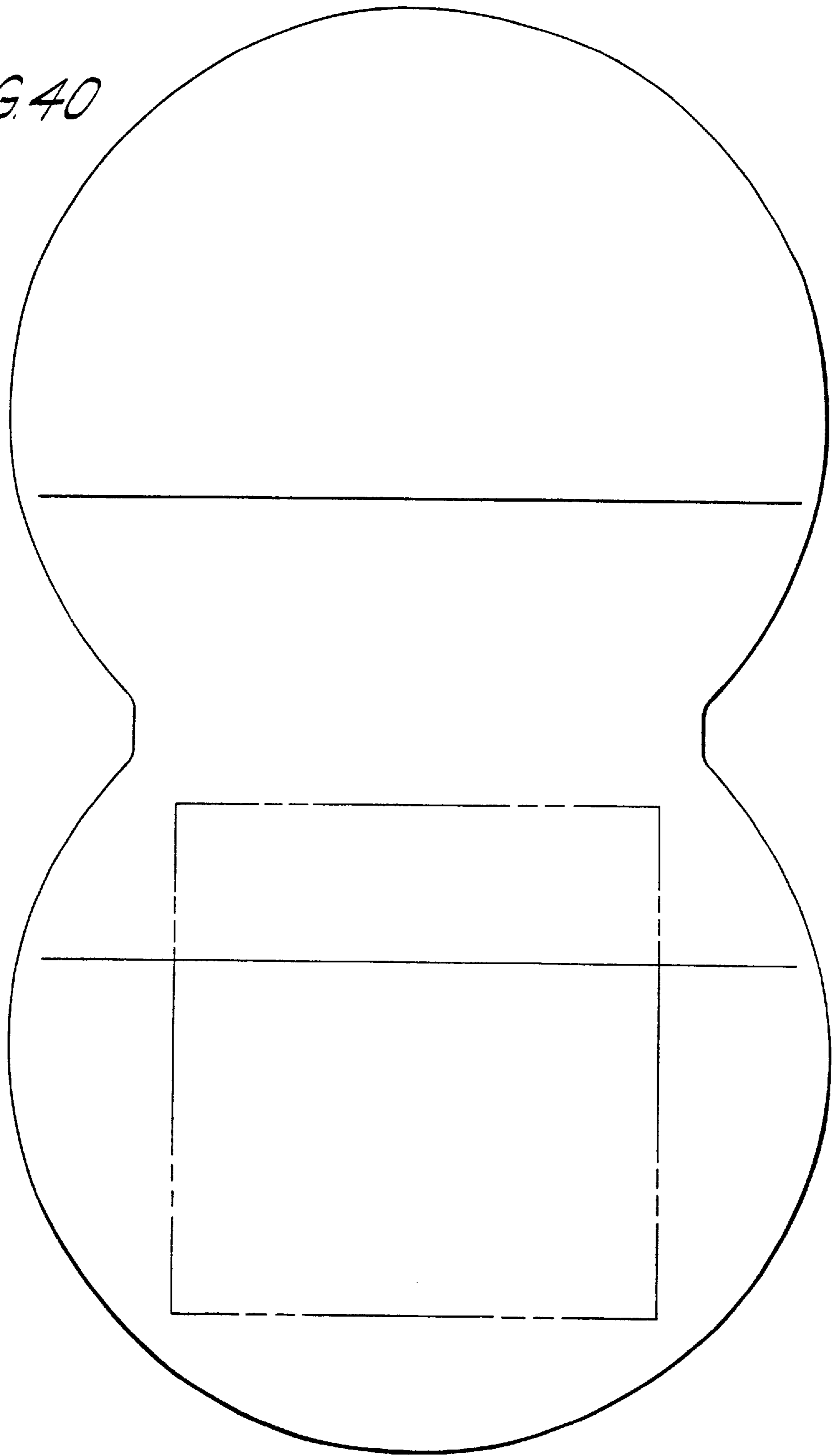

FIG. 41

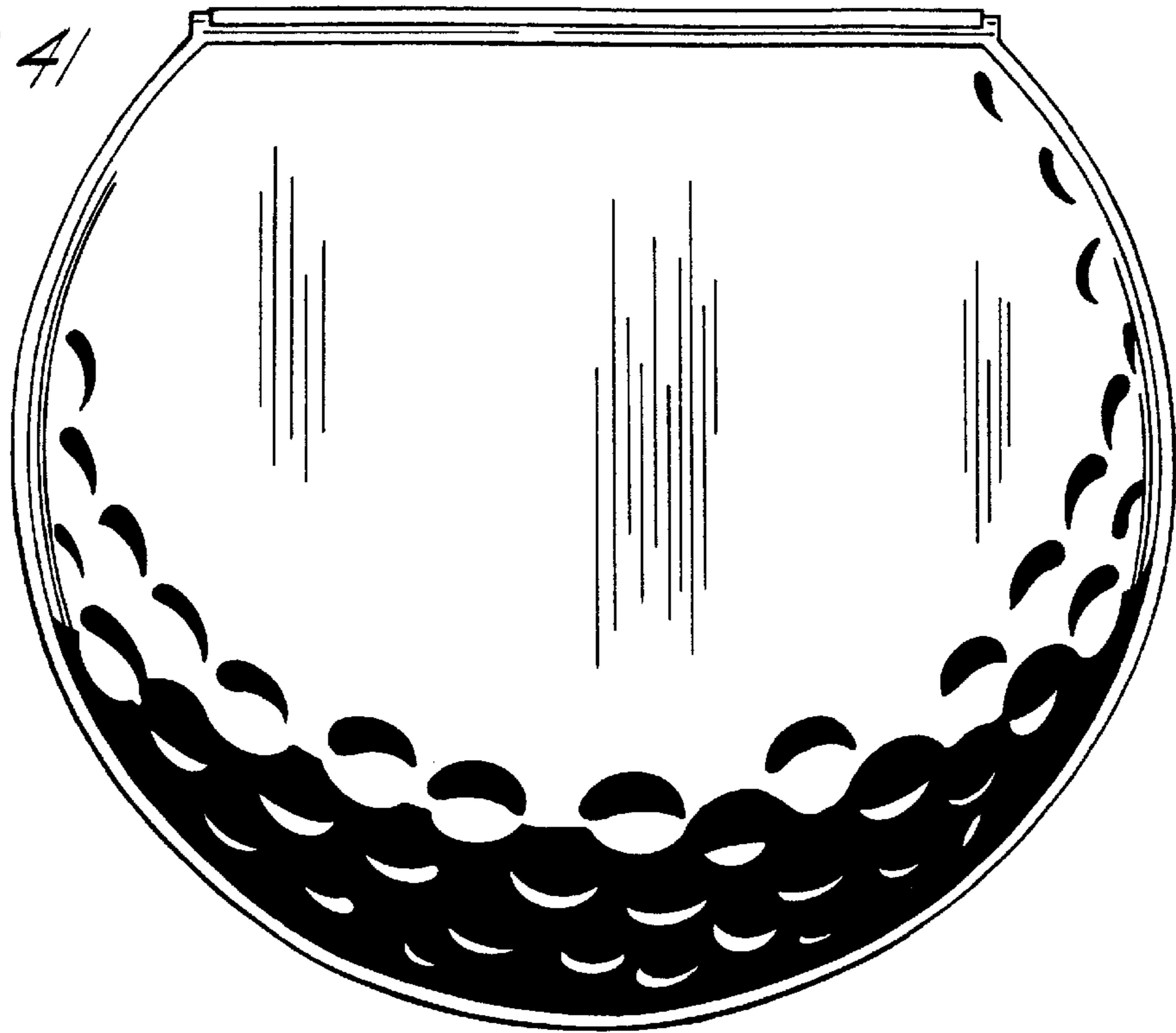

FIG. 42

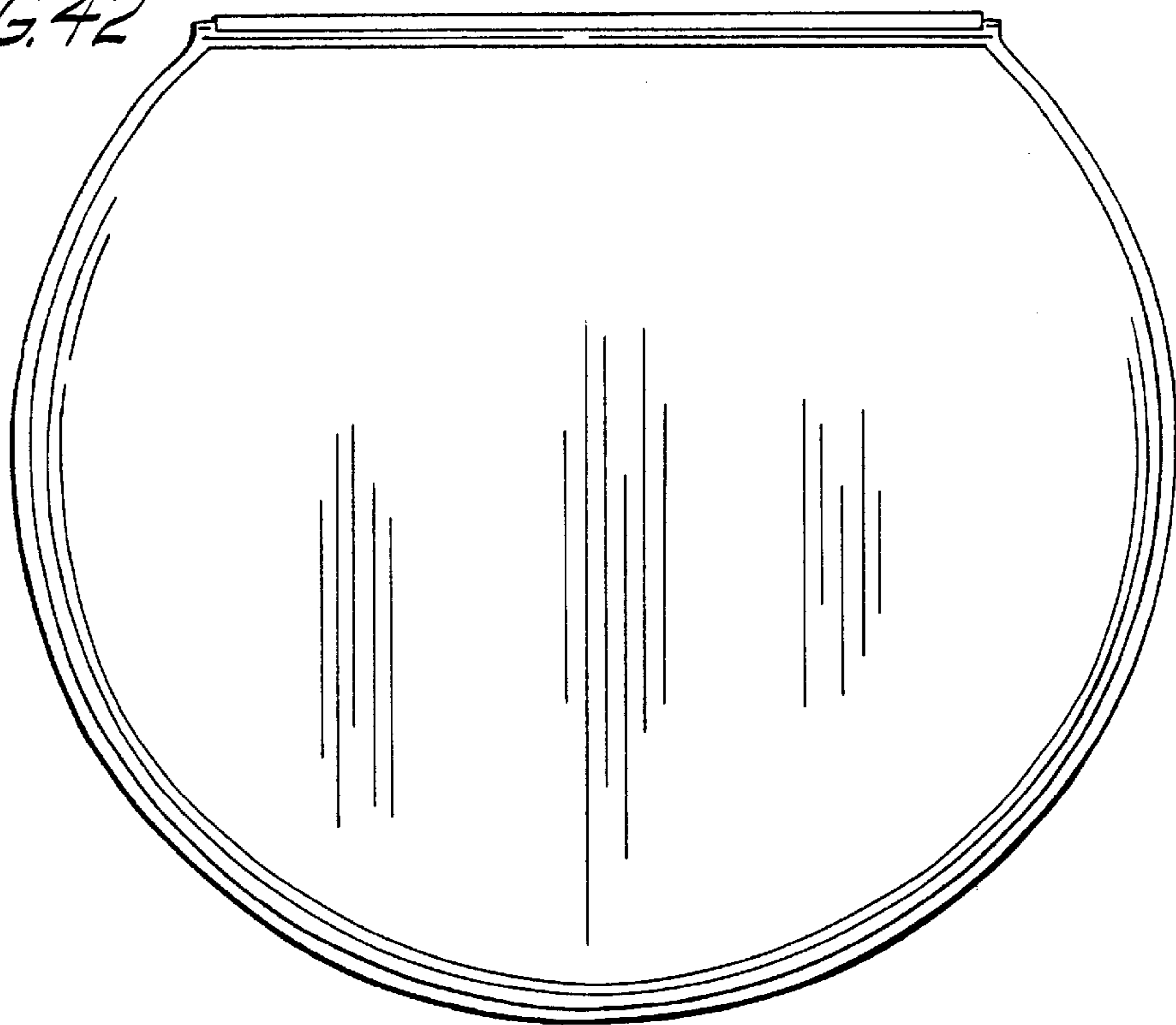

FIG. 43

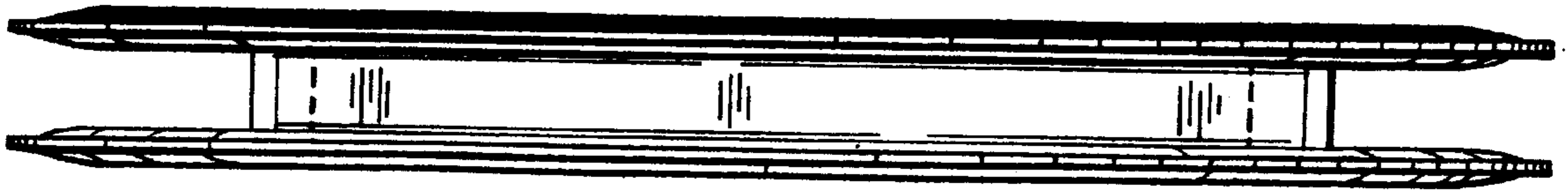

FIG. 44

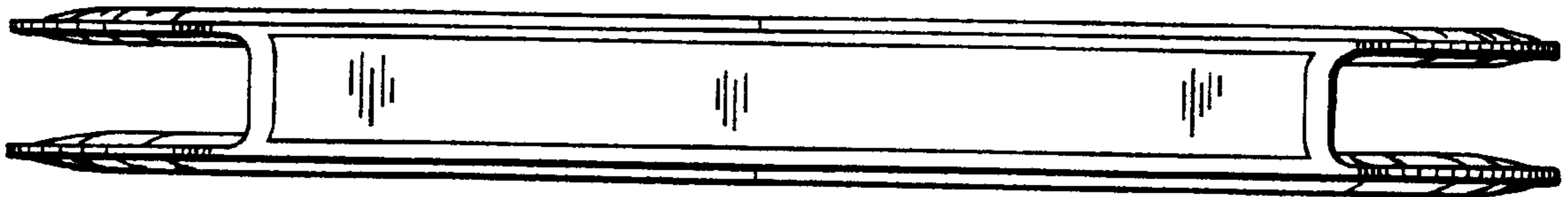

FIG. 45

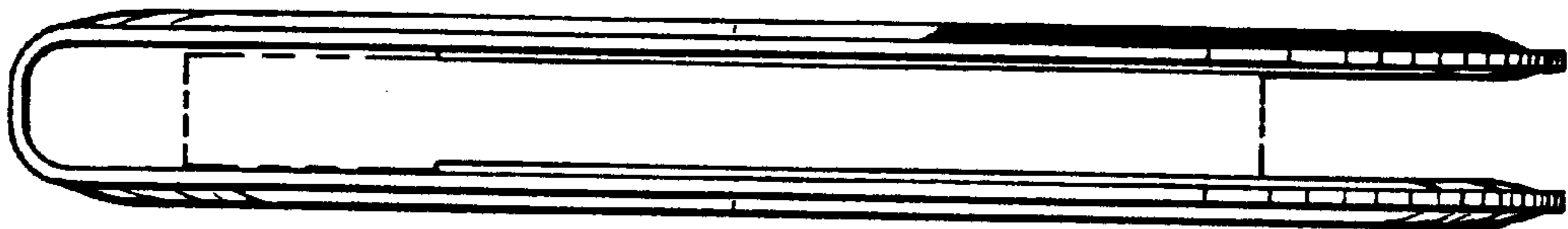

FIG. 46

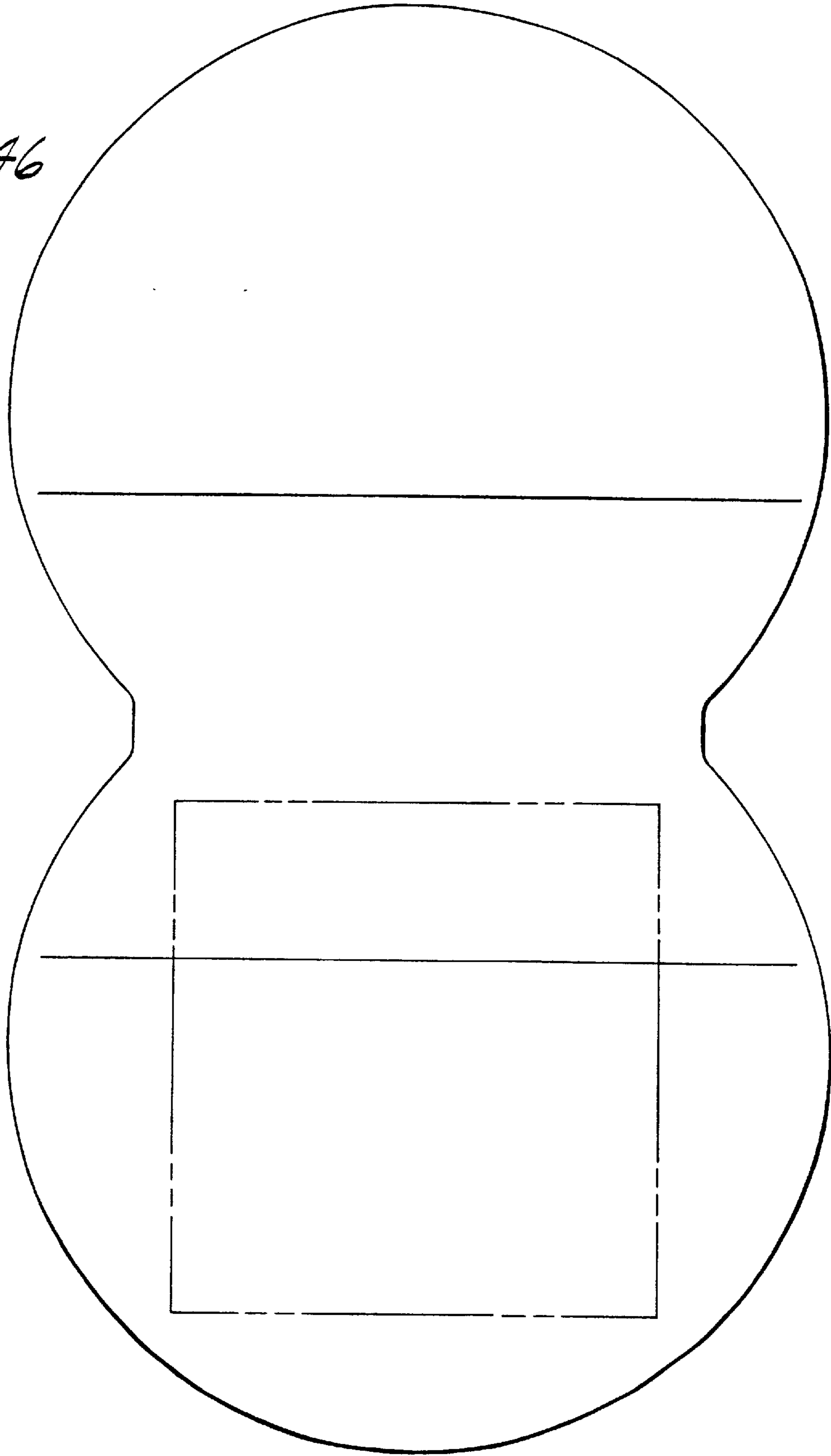

FIG. 47

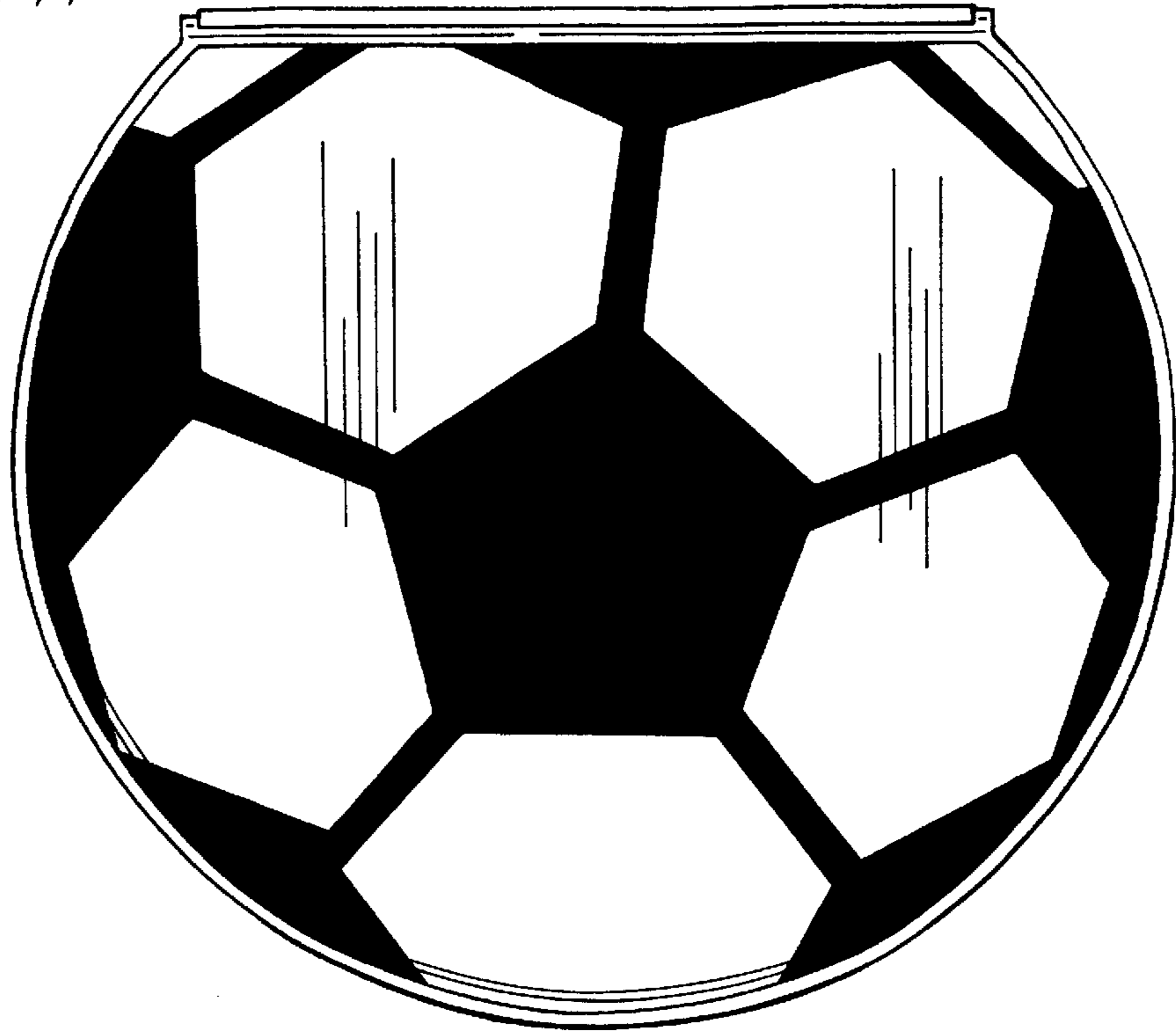

FIG. 48

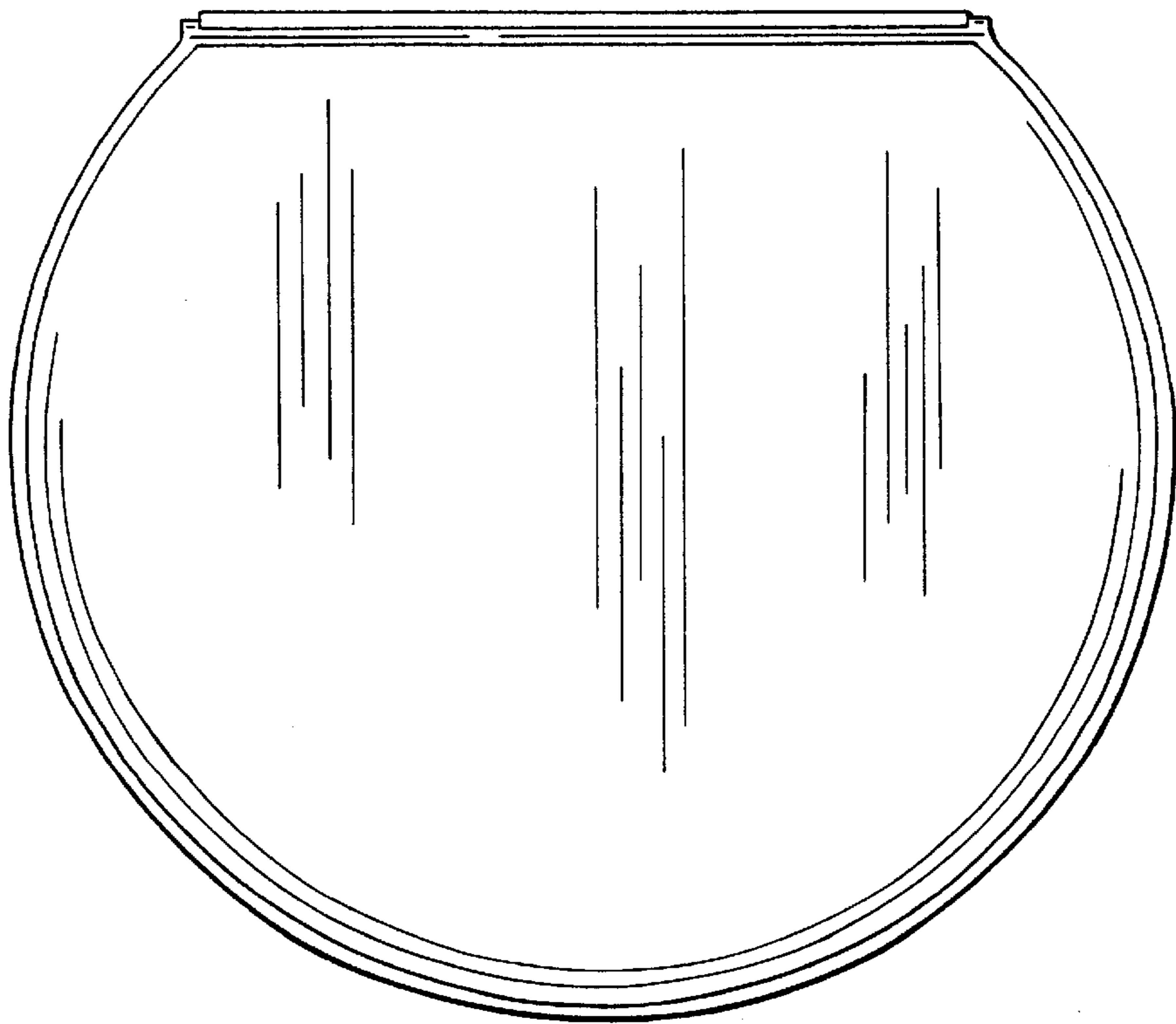

FIG. 49

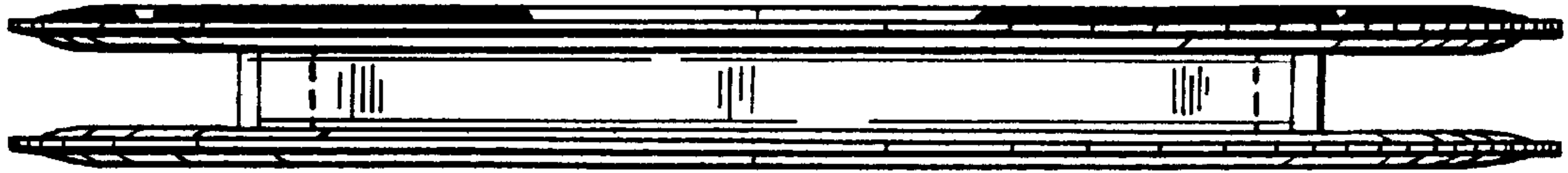

FIG. 50

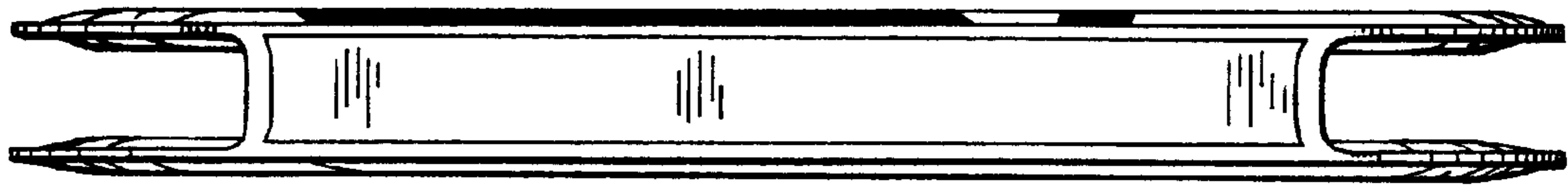

FIG. 51

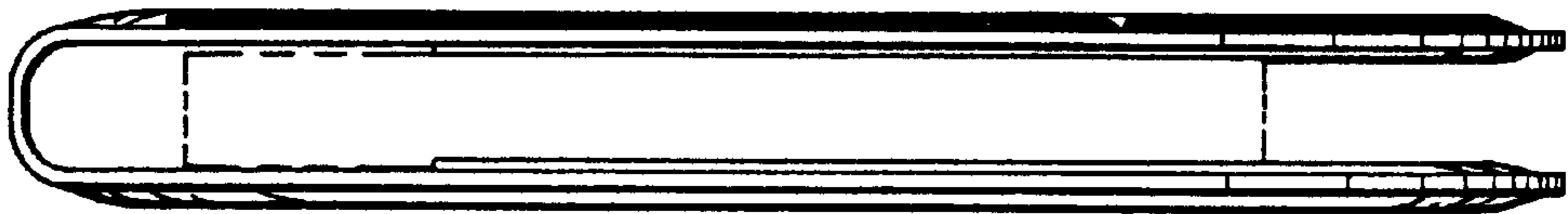

FIG. 52

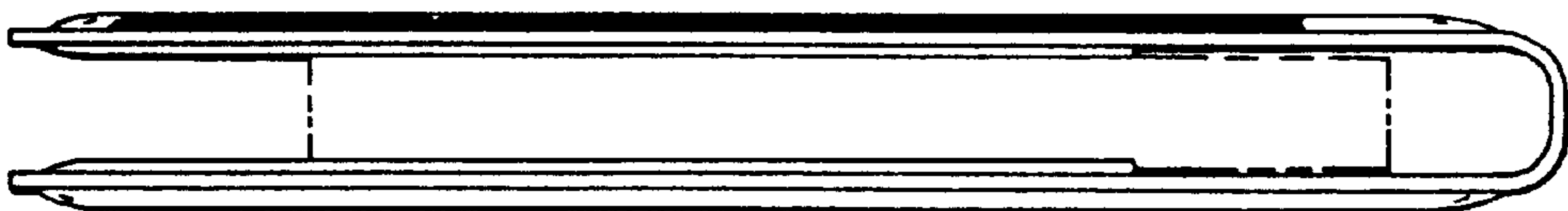

FIG. 53

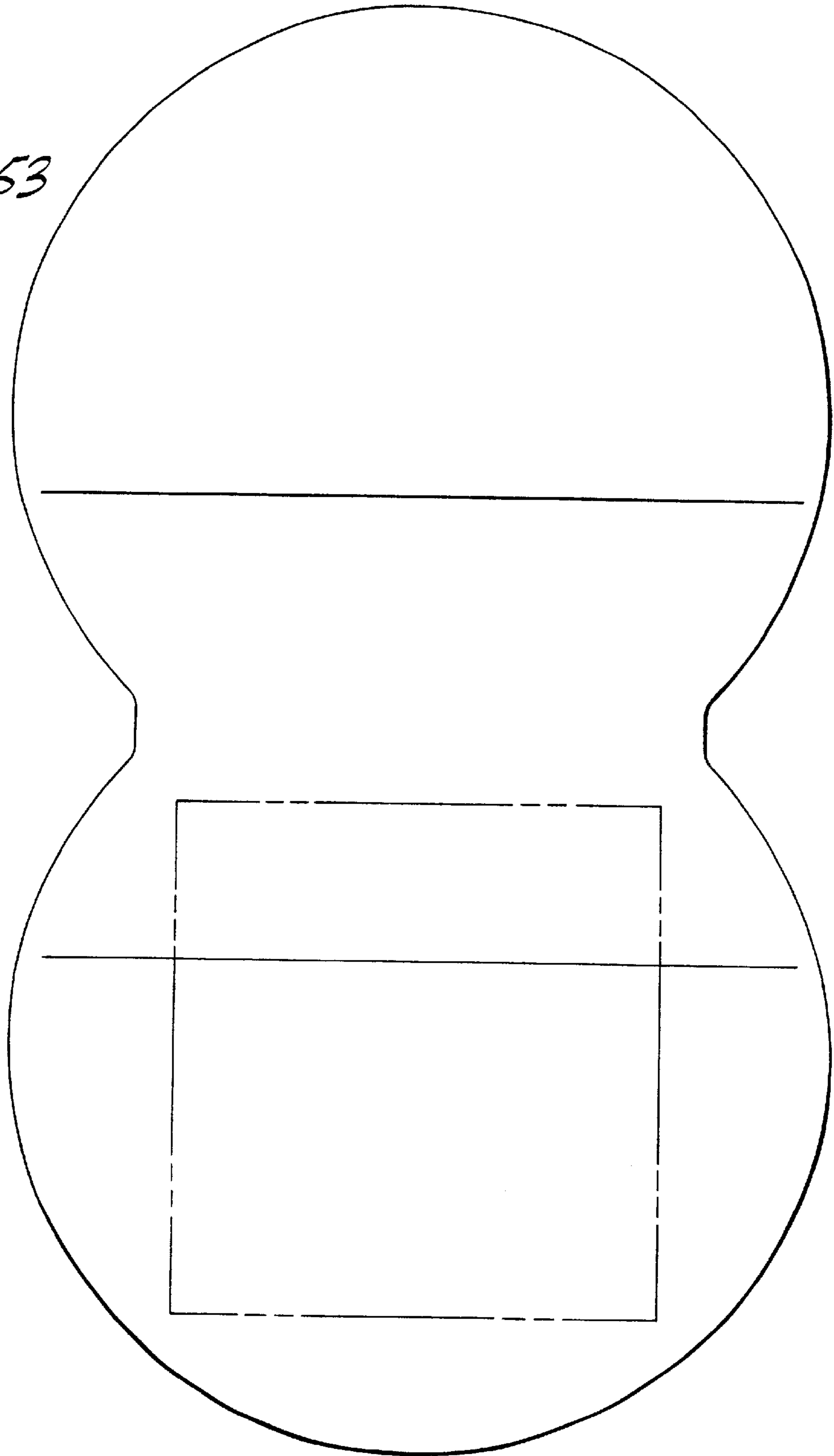

FIG. 54

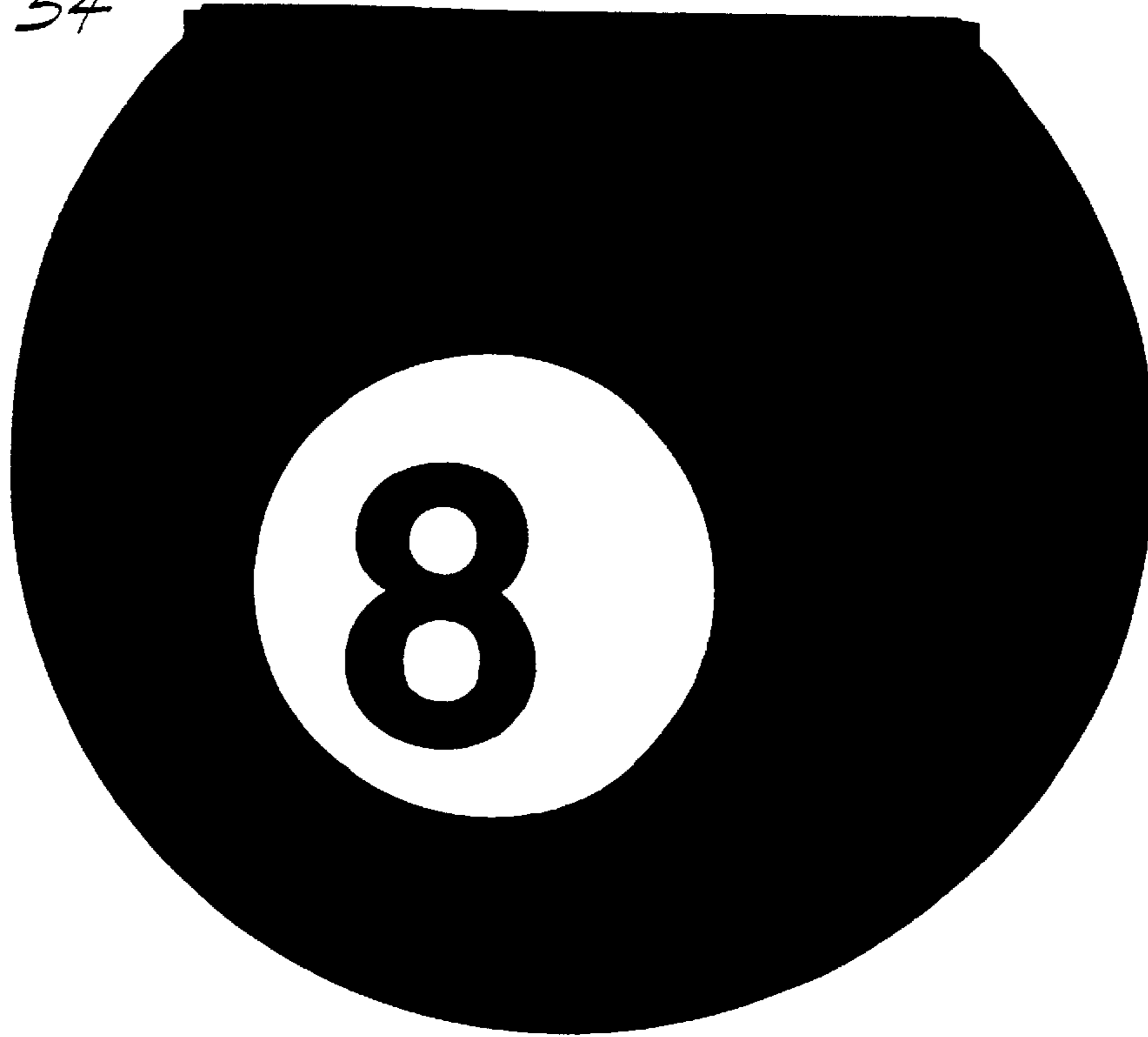

FIG. 55

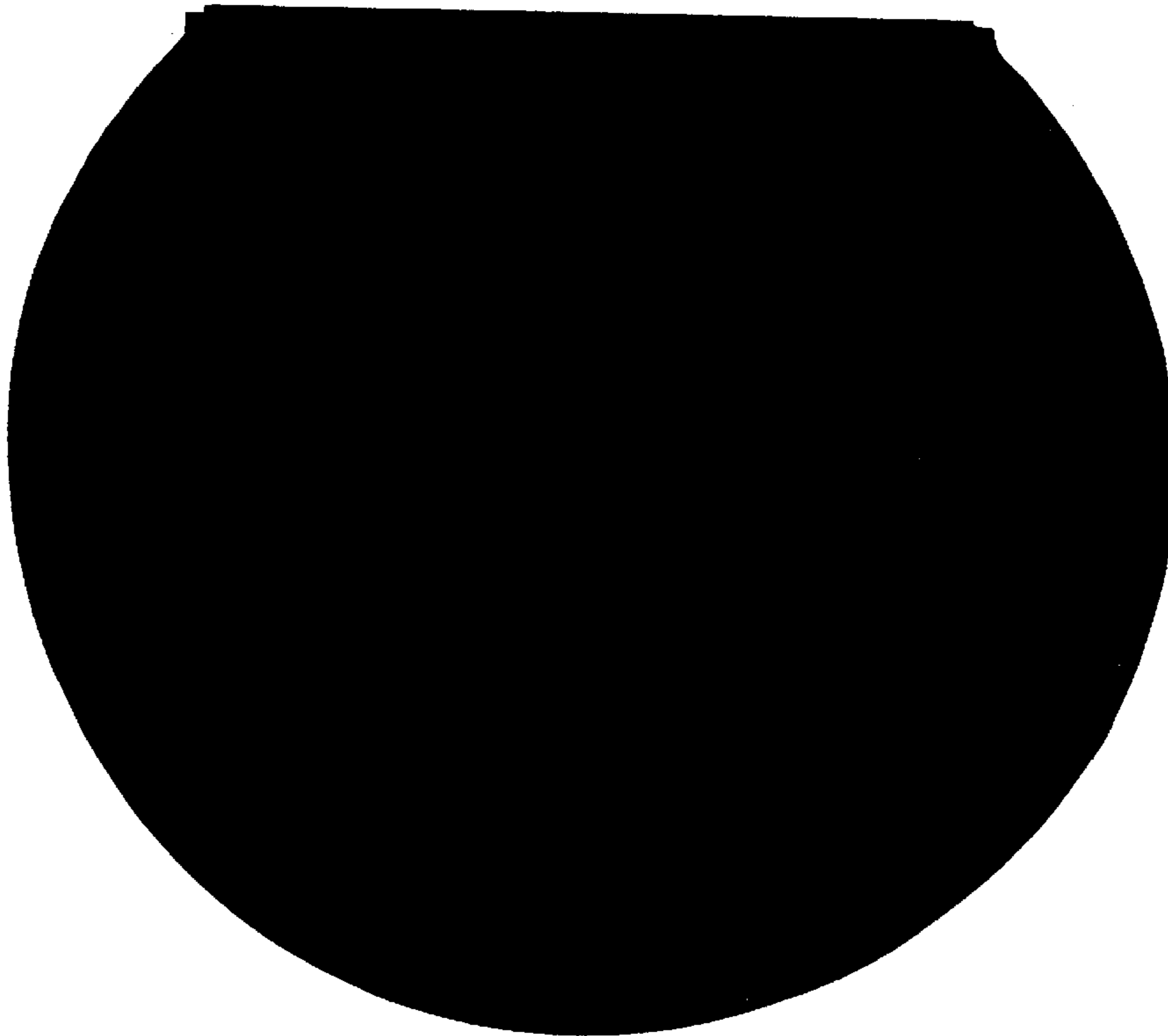

FIG. 56



FIG. 57



FIG. 58



FIG. 59

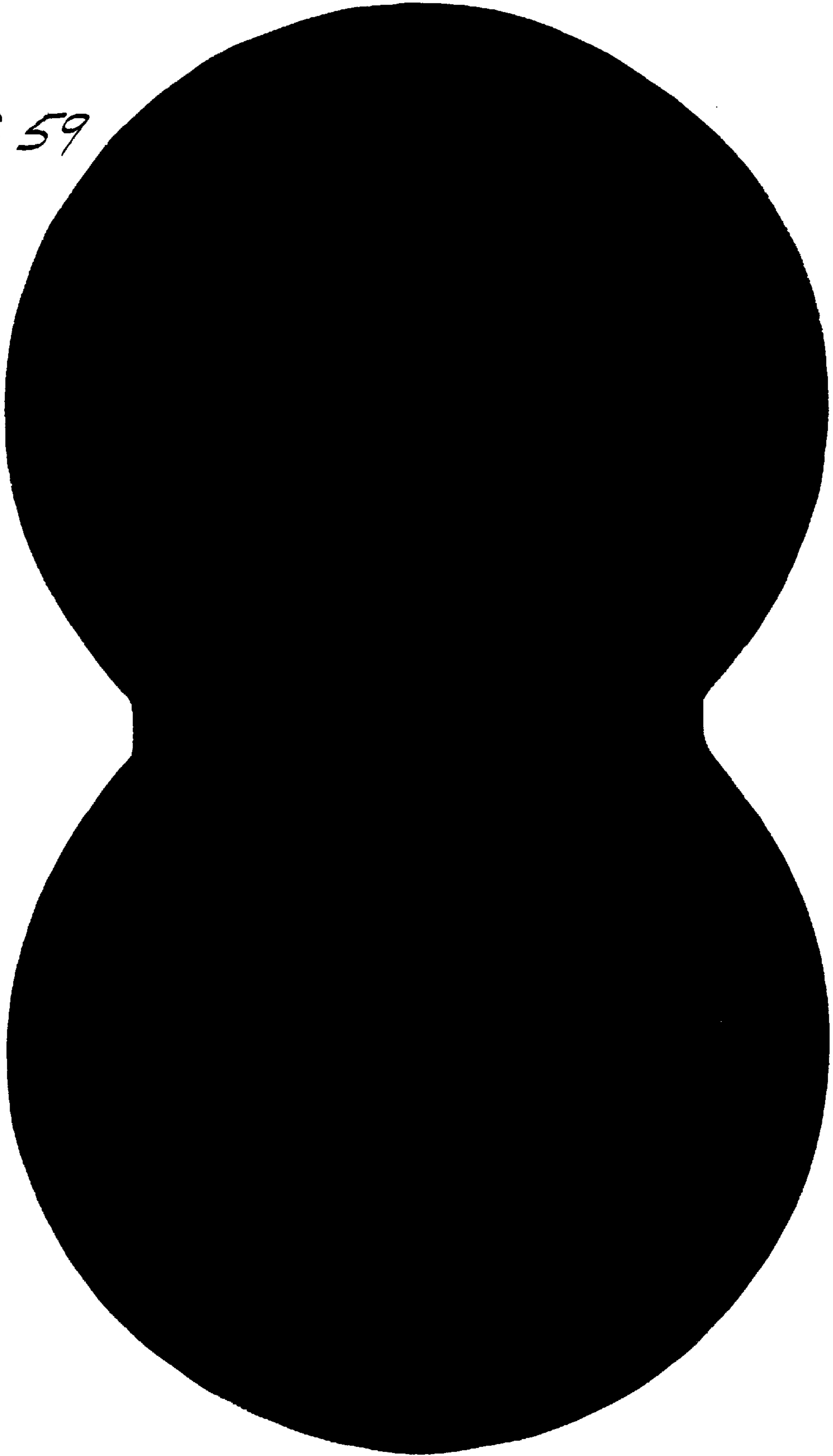

FIG. 60

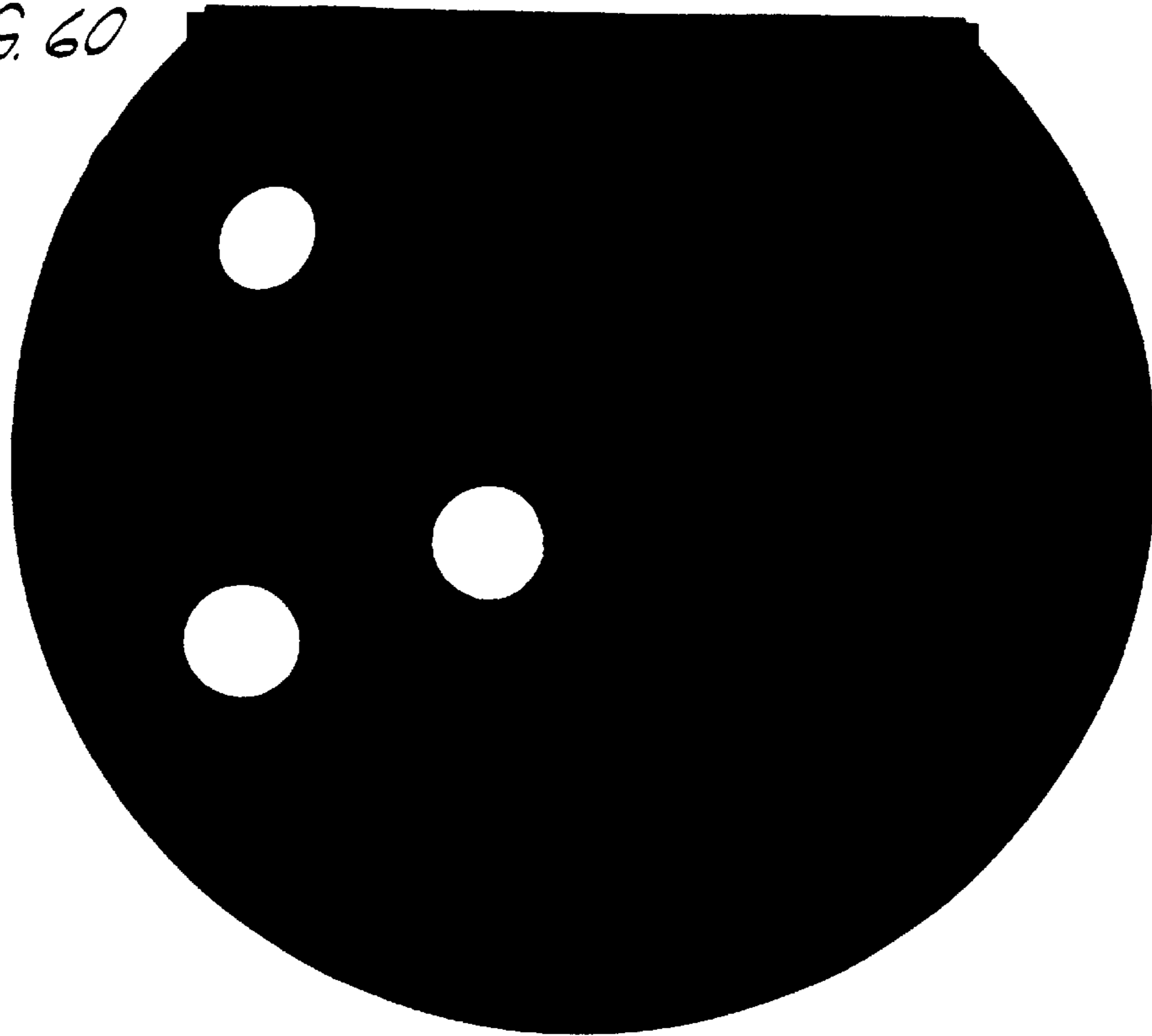

FIG. 61

