



US00D449459B1

(12) **United States Design Patent**  
**Diez Mintegi**

(10) **Patent No.:** **US D449,459 S**

(45) **Date of Patent:** **\*\* Oct. 23, 2001**

(54) **SEAT**

(75) **Inventor:** **Jose Antonio Diez Mintegi, Lasarte**  
**(ES)**

(73) **Assignee:** **Akaba, S.A. (ES)**

(\*\*) **Term:** **14 Years**

(21) **Appl. No.:** **29/134,665**

(22) **Filed:** **Dec. 27, 2000**

(51) **LOC (7) Cl.** ..... **06-01**

(52) **U.S. Cl.** ..... **D6/374; D6/379**

(58) **Field of Search** ..... **D6/334, 374, 375,**  
**D6/379, 380, 500, 501, 502; 297/445.1,**  
**446.1**

(56) **References Cited**

**U.S. PATENT DOCUMENTS**

D. 181,099	*	10/1957	Jones et al.	.....	D6/374
D. 215,836	*	11/1969	Bell, Jr. et al.	.....	D6/374
D. 219,032	*	10/1970	Christenson, Jr.	.....	D6/374
D. 313,705	*	1/1991	Hensel et al.	.....	D6/379 X
D. 335,041	*	4/1993	Meijer	.....	D6/379
D. 336,795	*	6/1993	Rowe et al.	.....	D6/380
D. 357,821	*	5/1995	Tedesco	.....	D6/379
D. 390,026	*	2/1998	Biecher	.....	D6/375
D. 413,740	*	9/1999	Frinier	.....	D6/379

\* cited by examiner

*Primary Examiner*—Gary D. Watson

(74) *Attorney, Agent, or Firm*—Bierman, Muserlian and Lucas

(57) **CLAIM**

The ornamental design for a seat, substantially as shown and described.

**DESCRIPTION**

FIG. 1 is a perspective view of my seat design;  
 FIG. 2 is a front view of my seat design;  
 FIG. 3 is a back view of my seat design;  
 FIG. 4 is a right-side view of my seat design;  
 FIG. 5 is a left-side view of my seat design;  
 FIG. 6 is a top view of my seat design;  
 FIG. 7 is a bottom view of my seat design;  
 FIG. 8 is a perspective view of a second embodiment of my seat design;  
 FIG. 9 is a front view of a second embodiment of my seat design;  
 FIG. 10 is a back view of a second embodiment of my seat design;  
 FIG. 11 is a right-side view of a second embodiment of my seat design;  
 FIG. 12 is a left-side view of a second embodiment of my seat design;  
 FIG. 13 is a top view of a second embodiment of my seat design; and,  
 FIG. 14 is a bottom view of a second embodiment of my seat design.

**1 Claim, 14 Drawing Sheets**

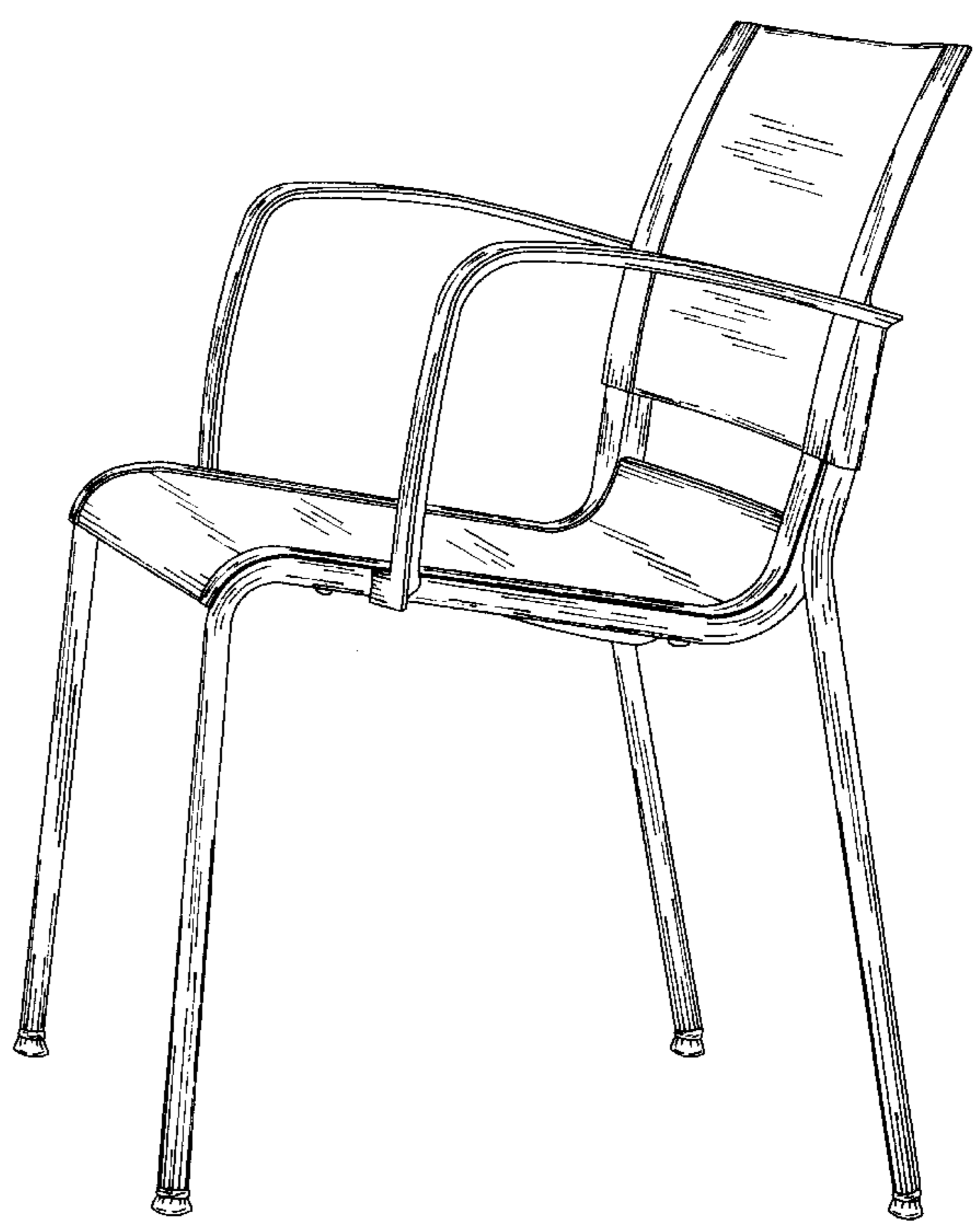
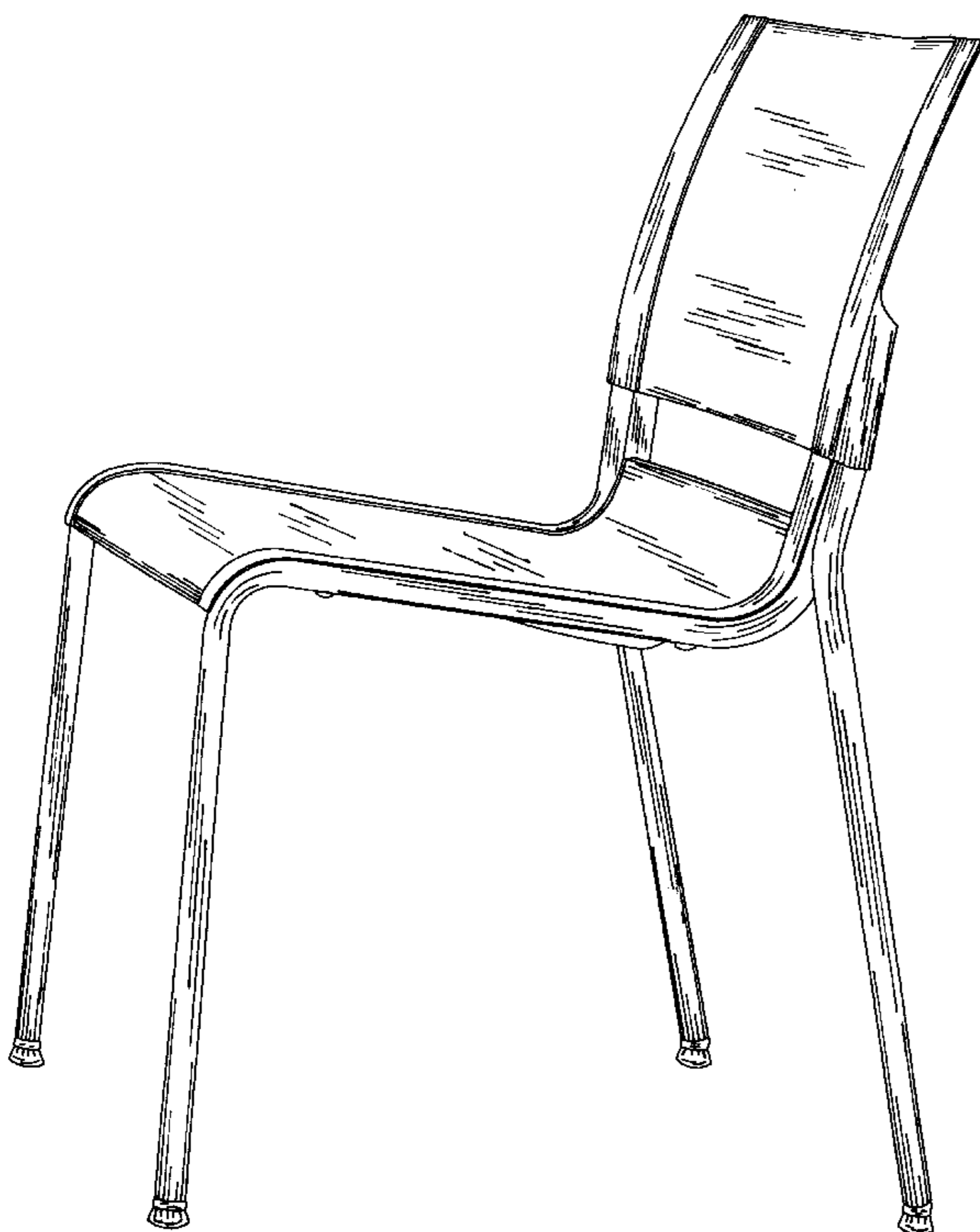

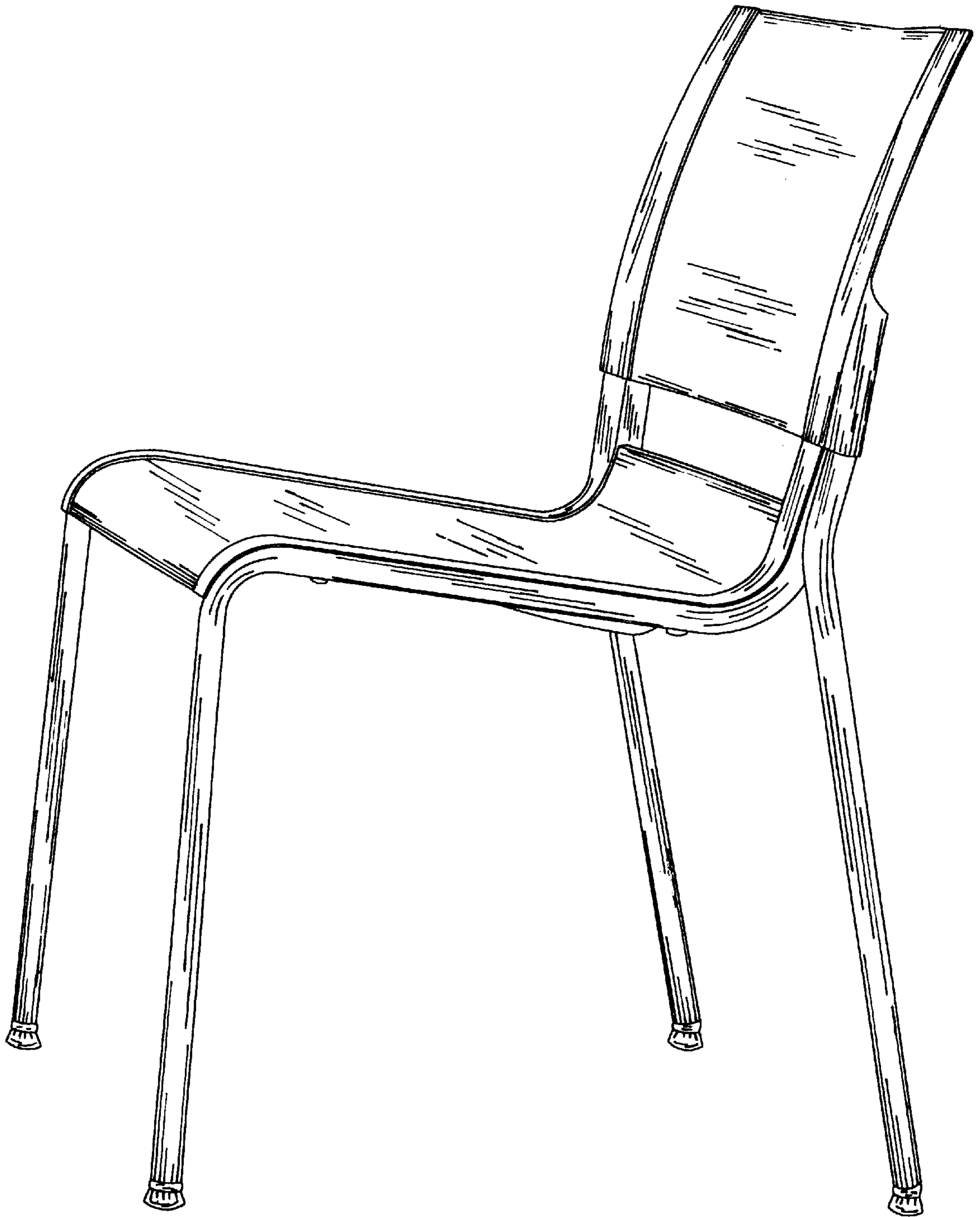

Fig. 1

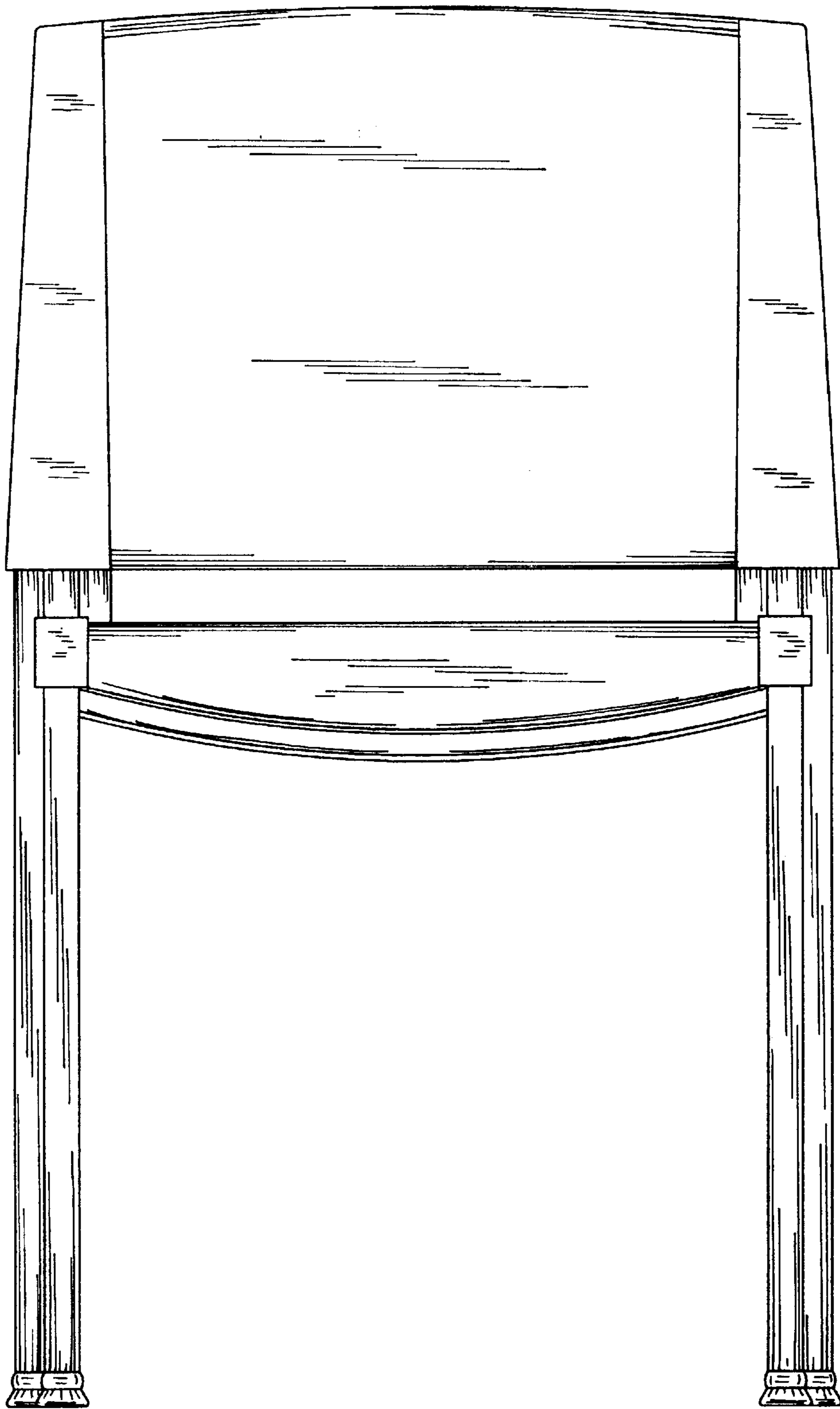

Fig. 2

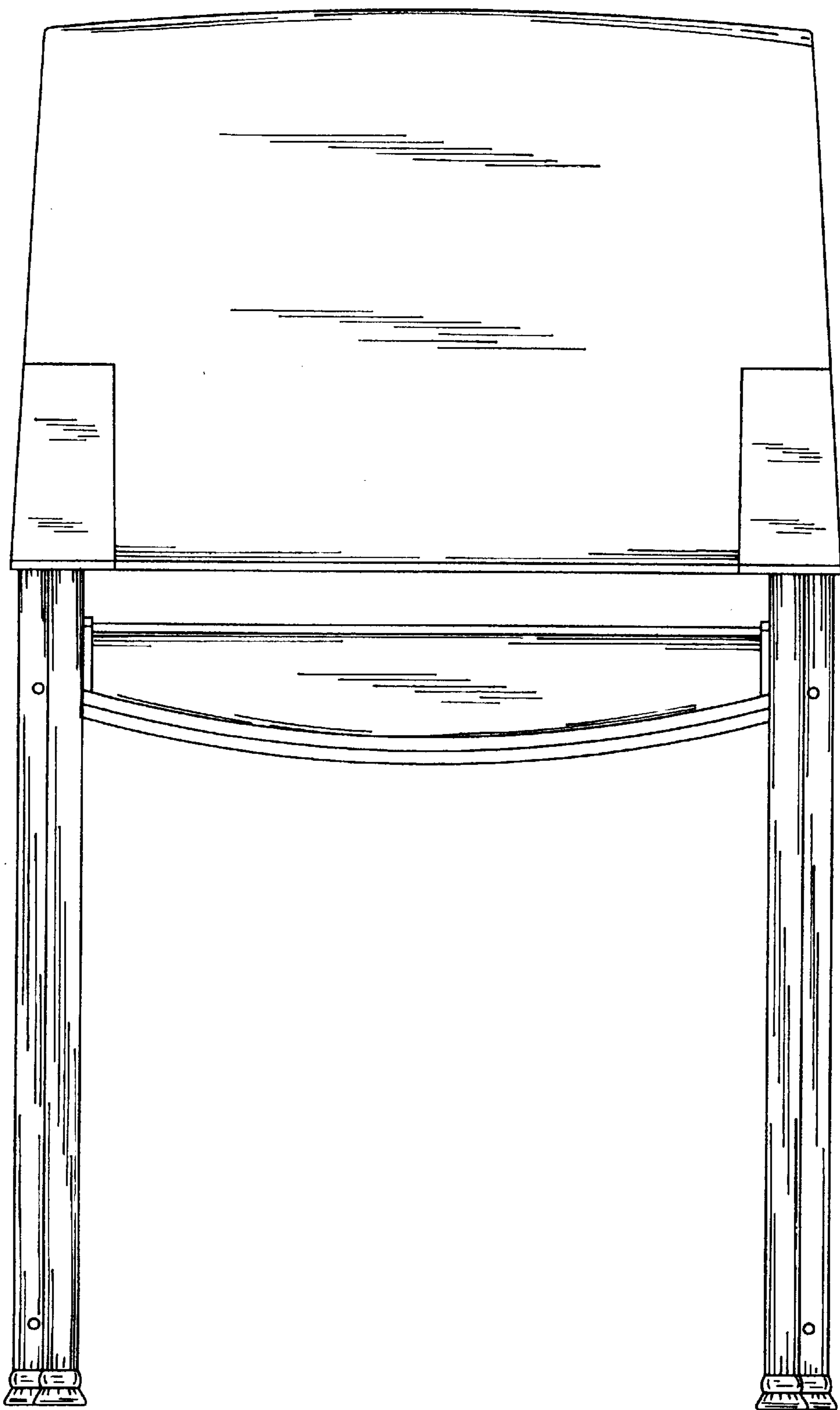

Fig. 3

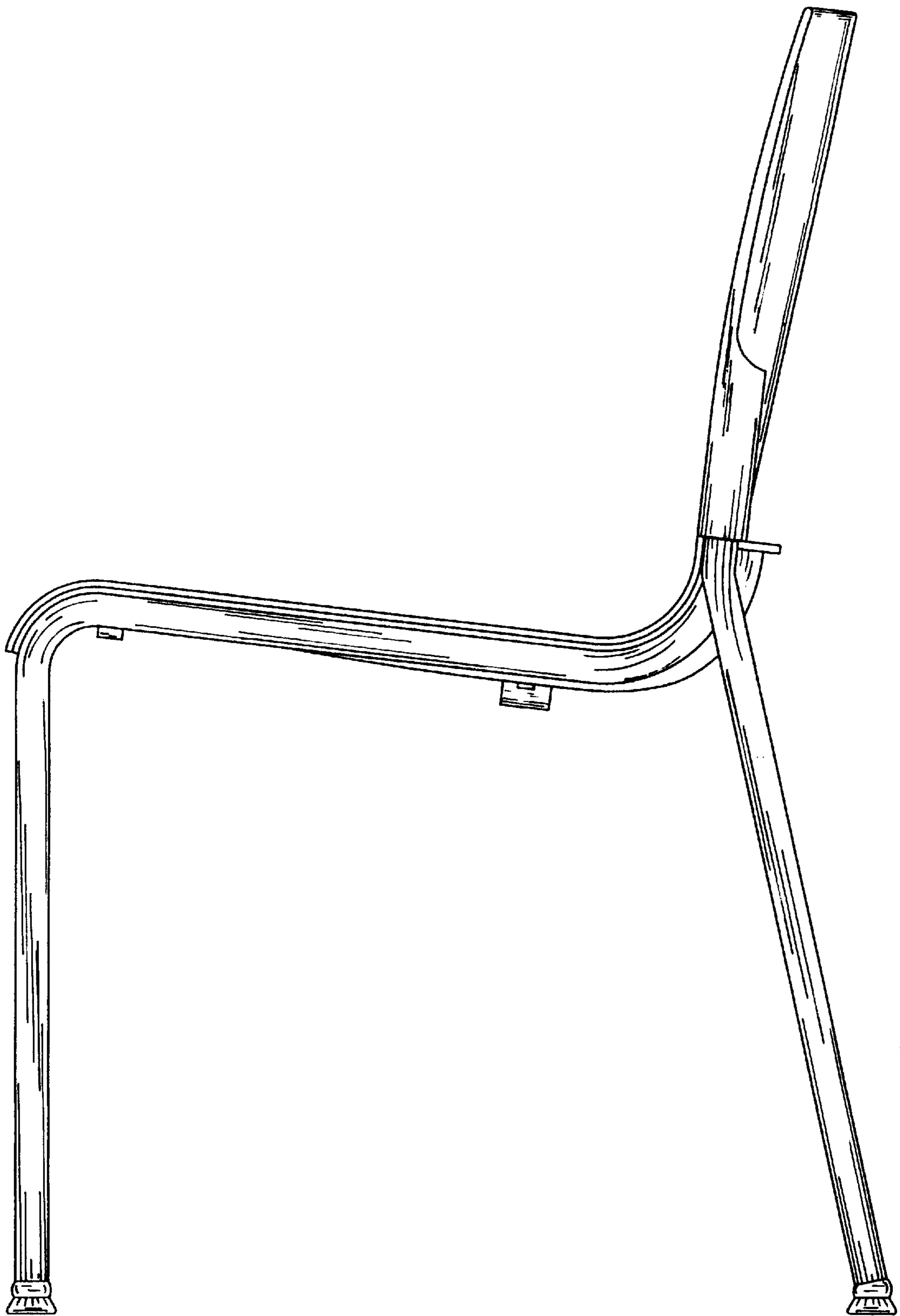

Fig. 4

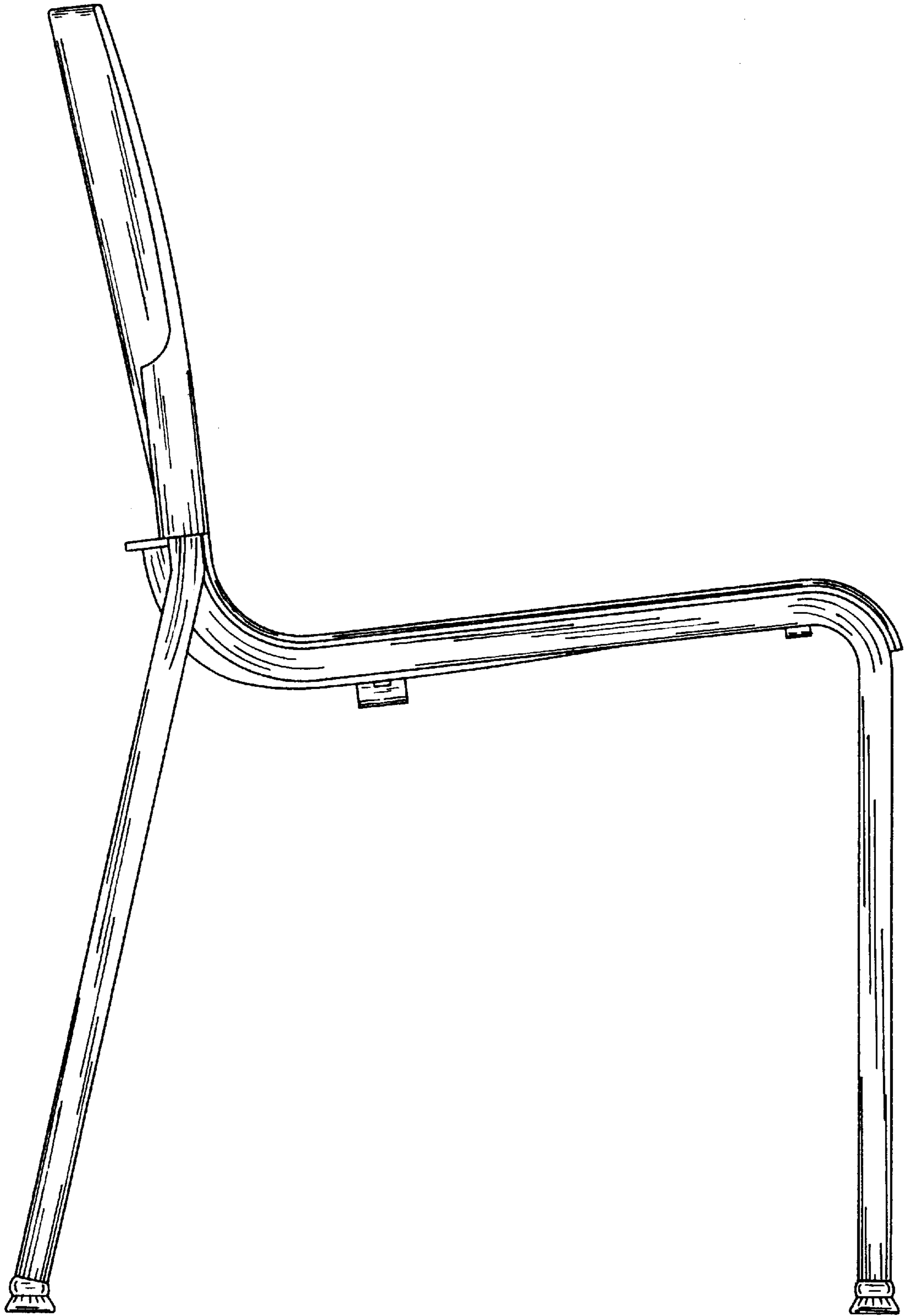

Fig. 5

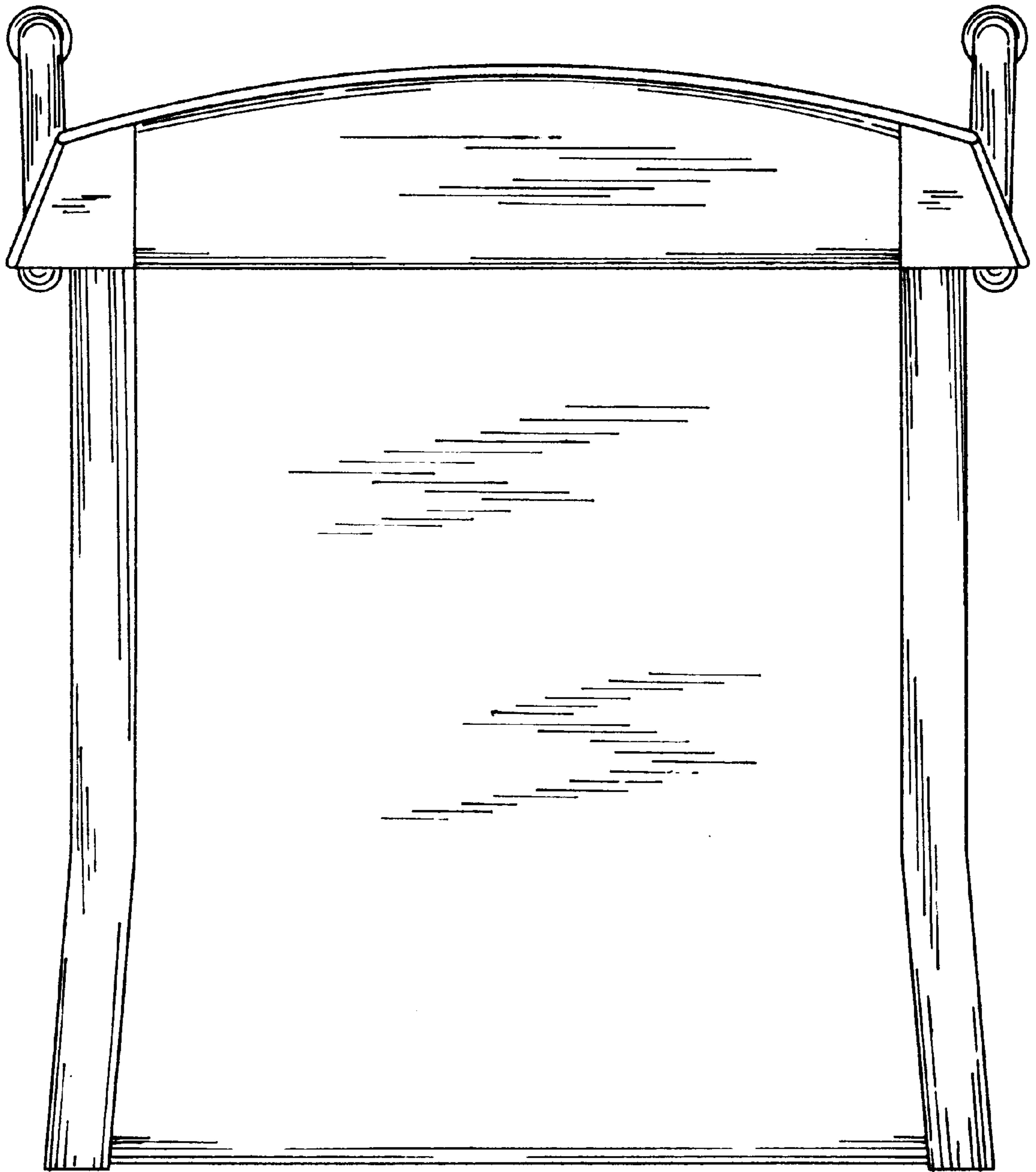

Fig. 6

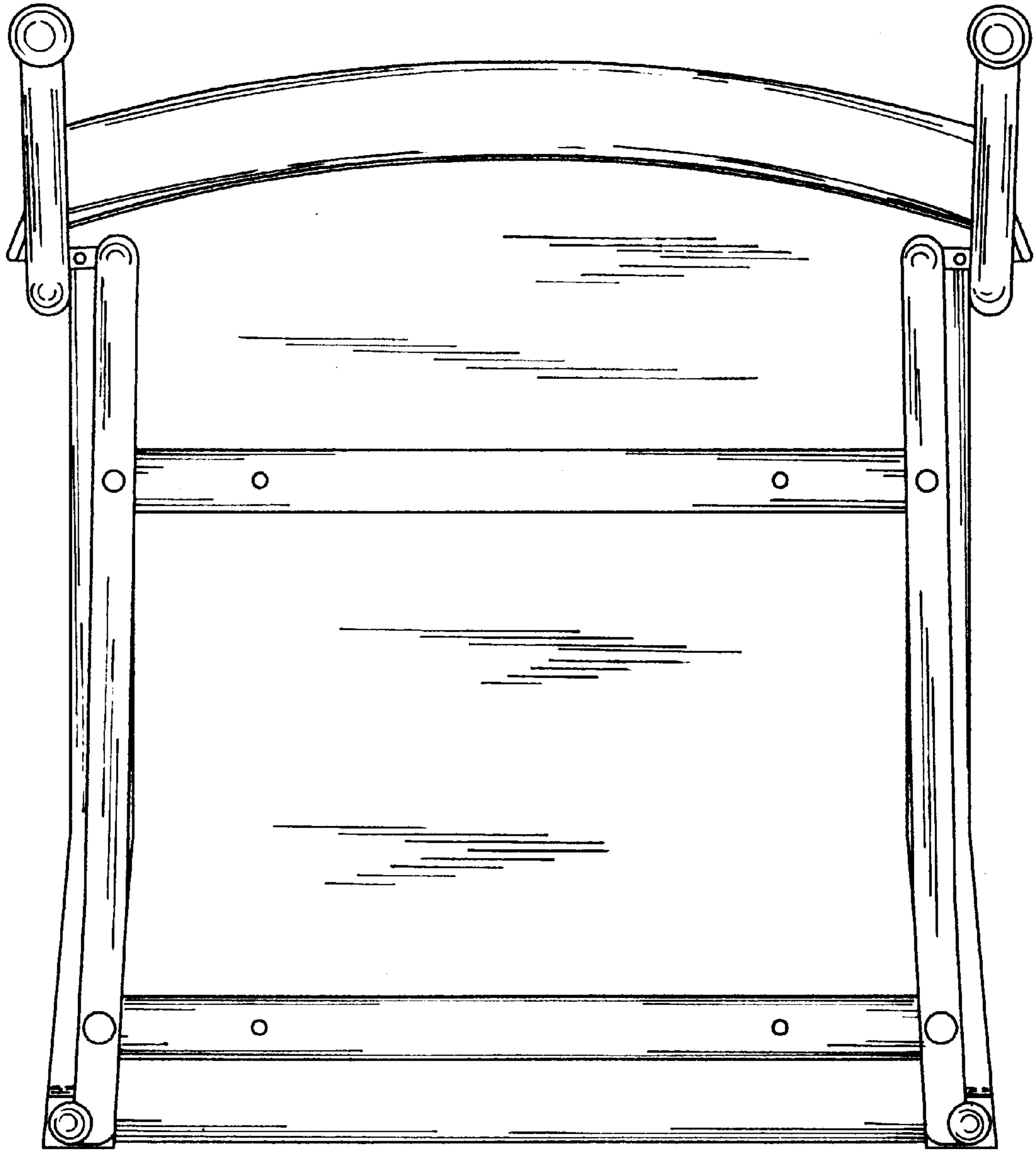

Fig. 7



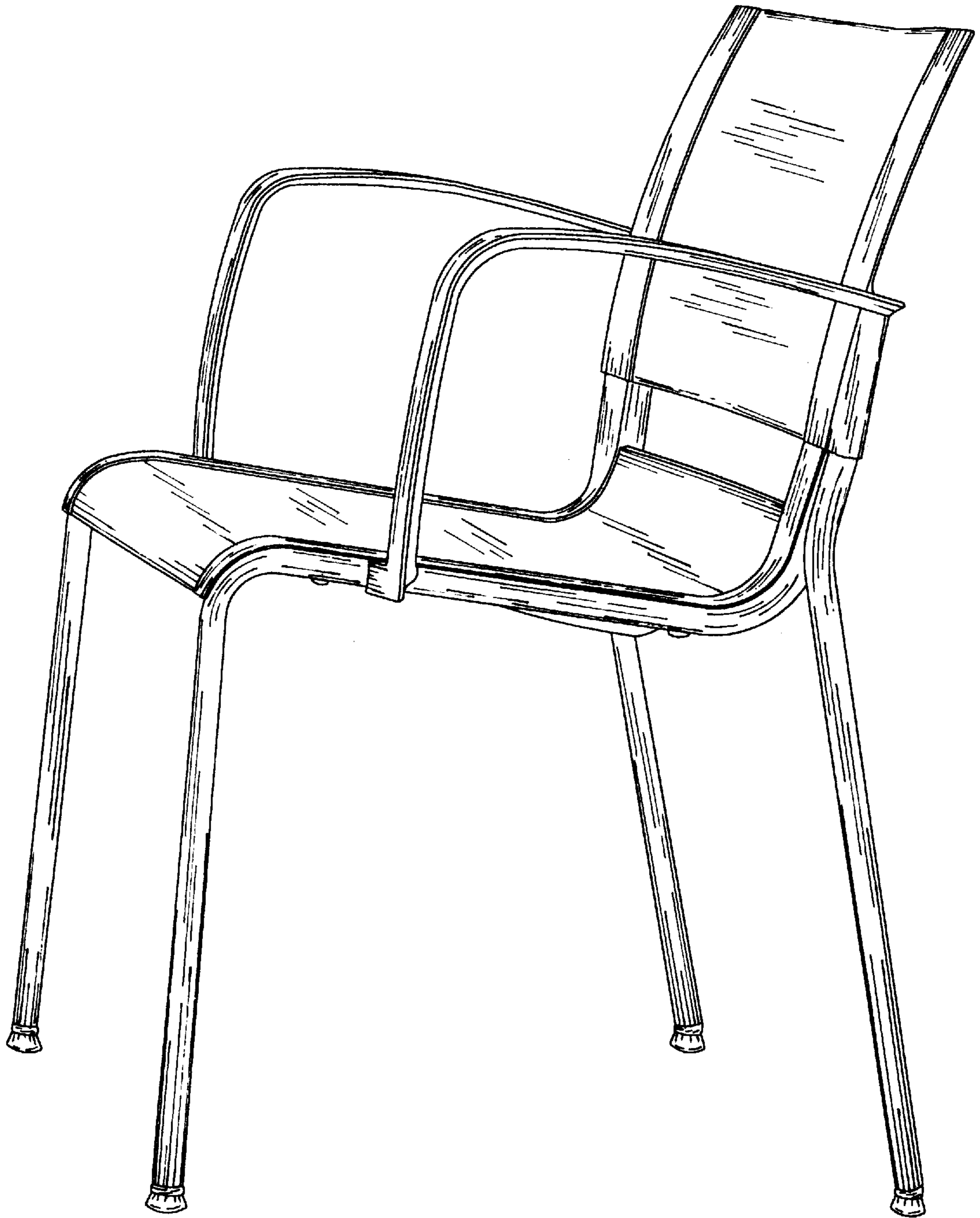

Fig. 8

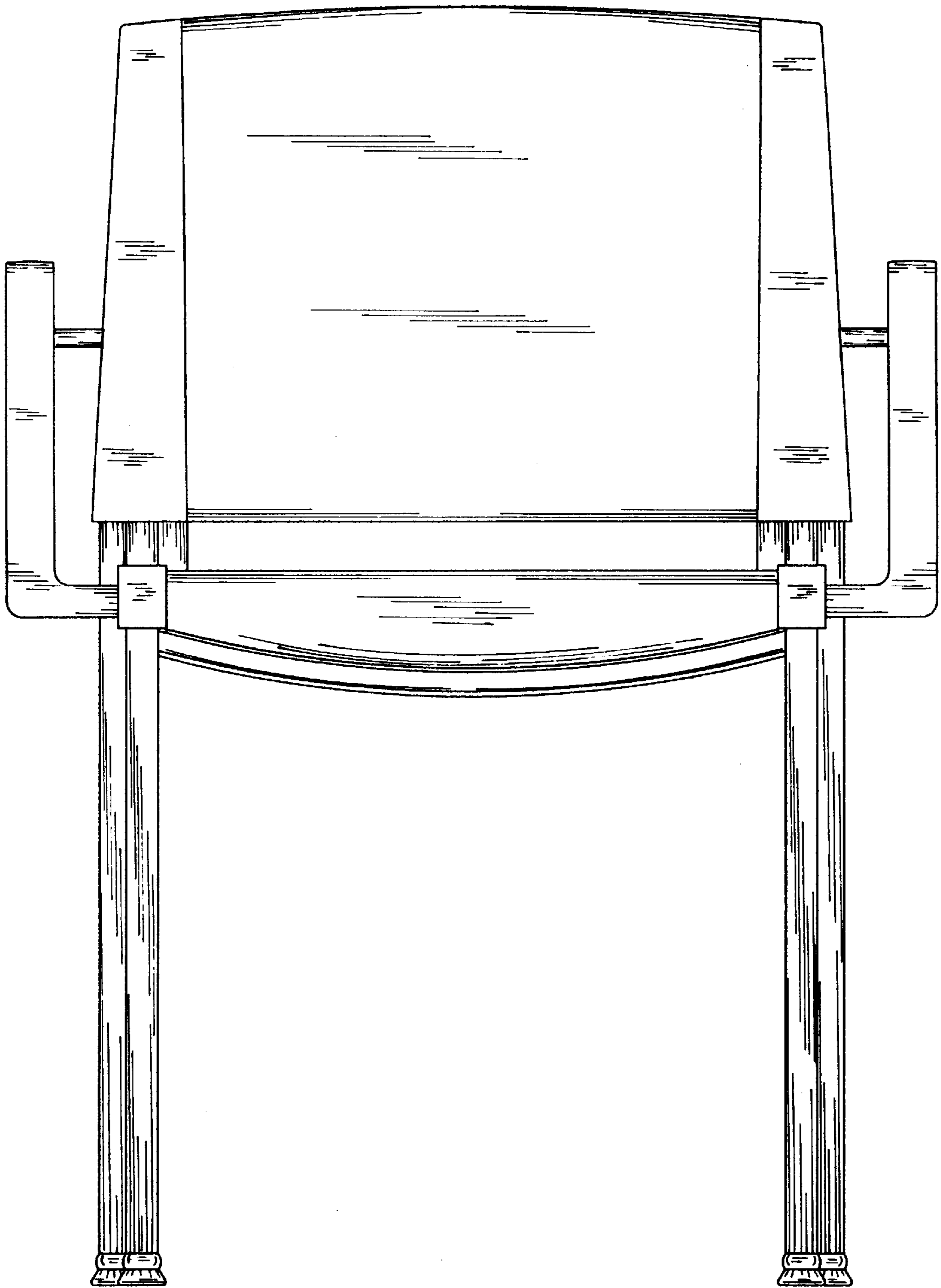

Fig. 9

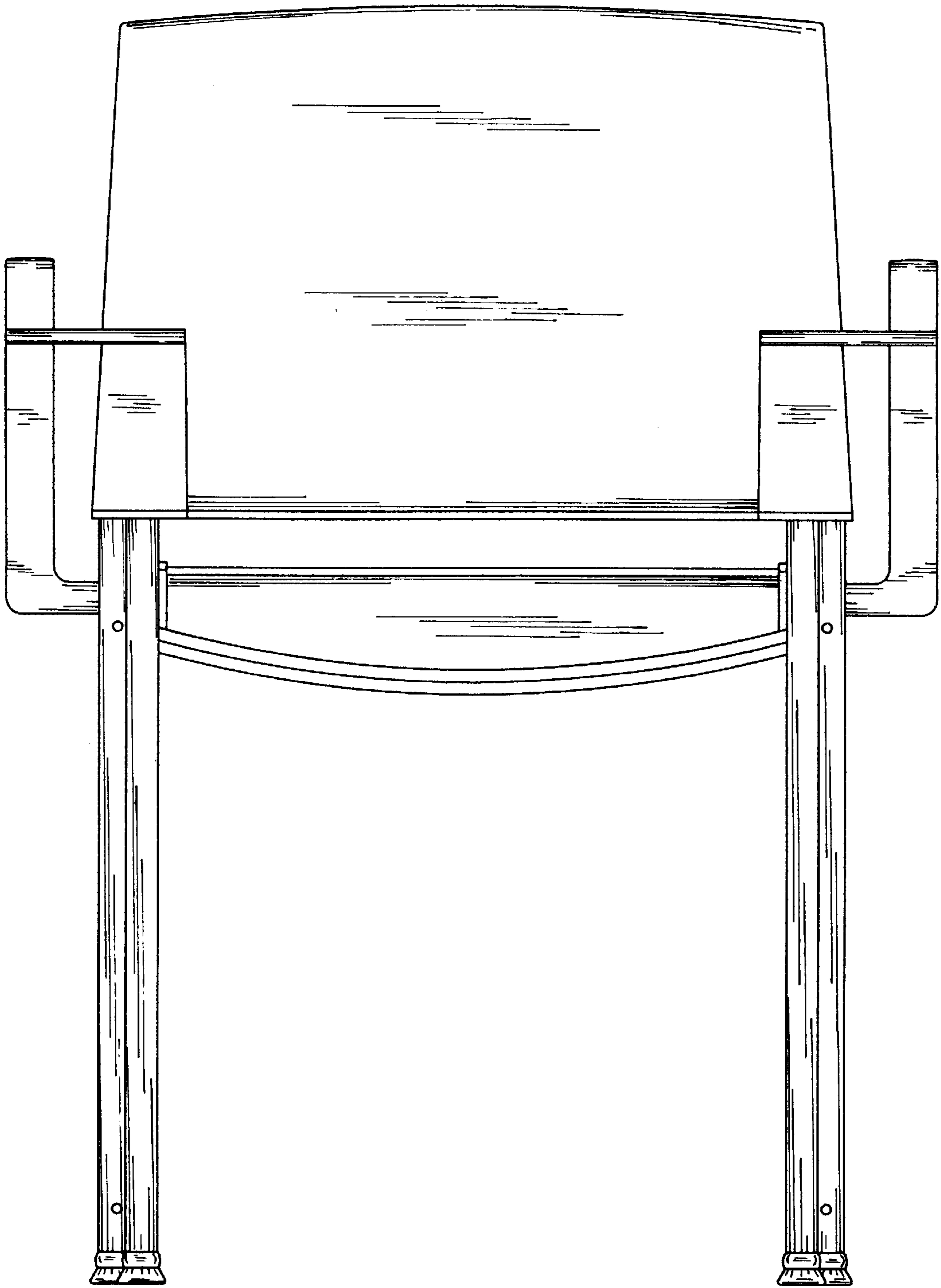

Fig. 10

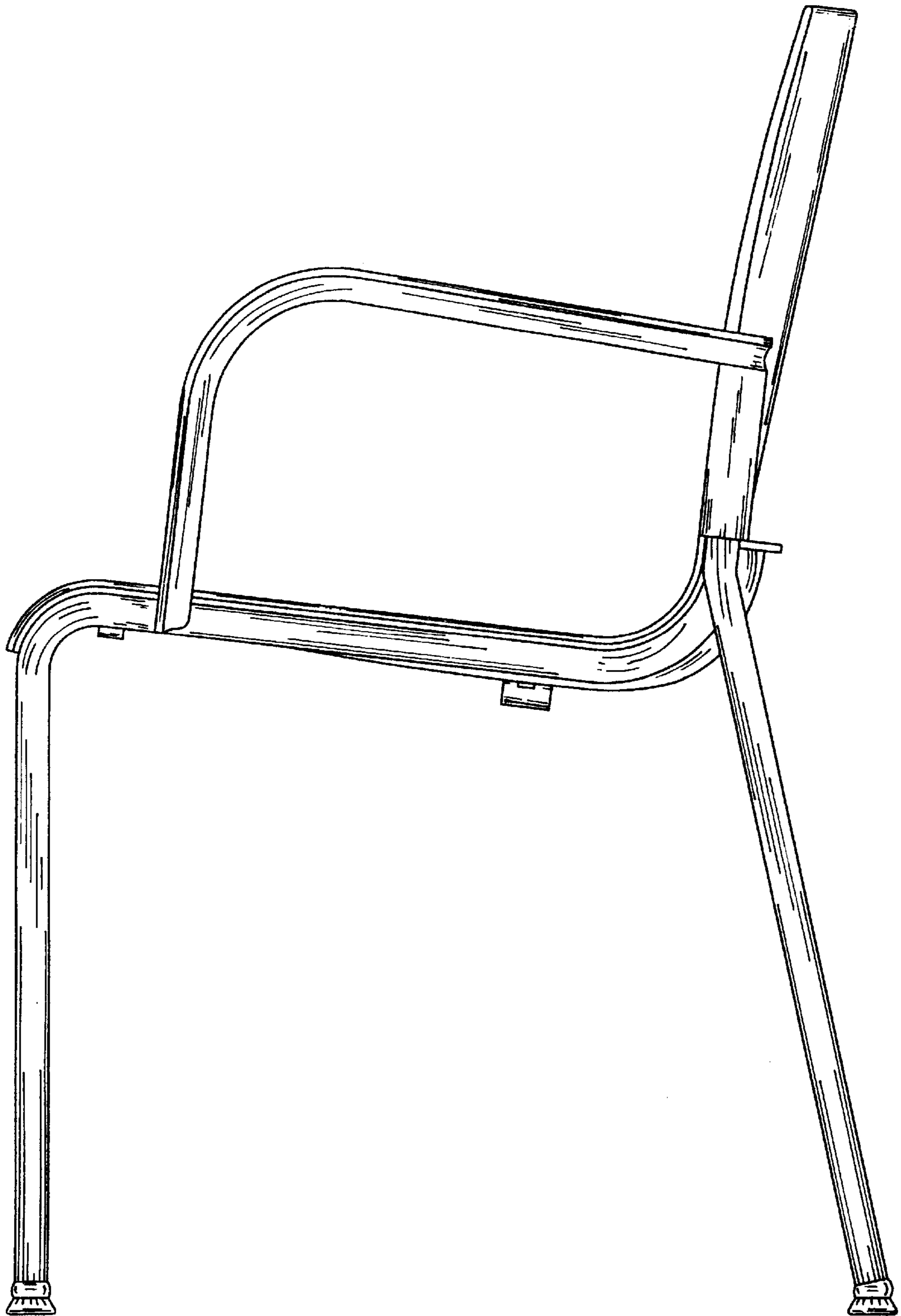

Fig. 11

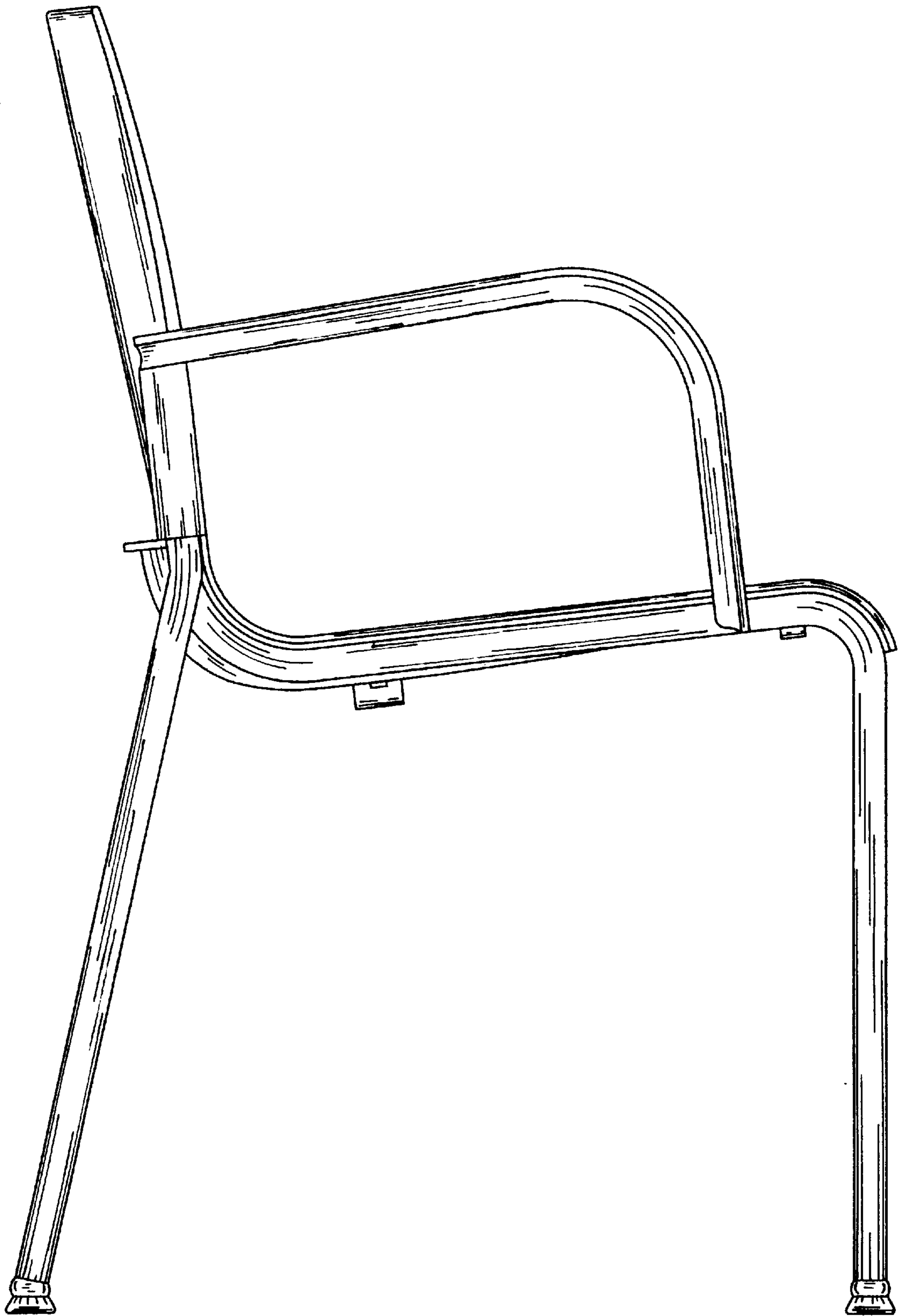

Fig. 12

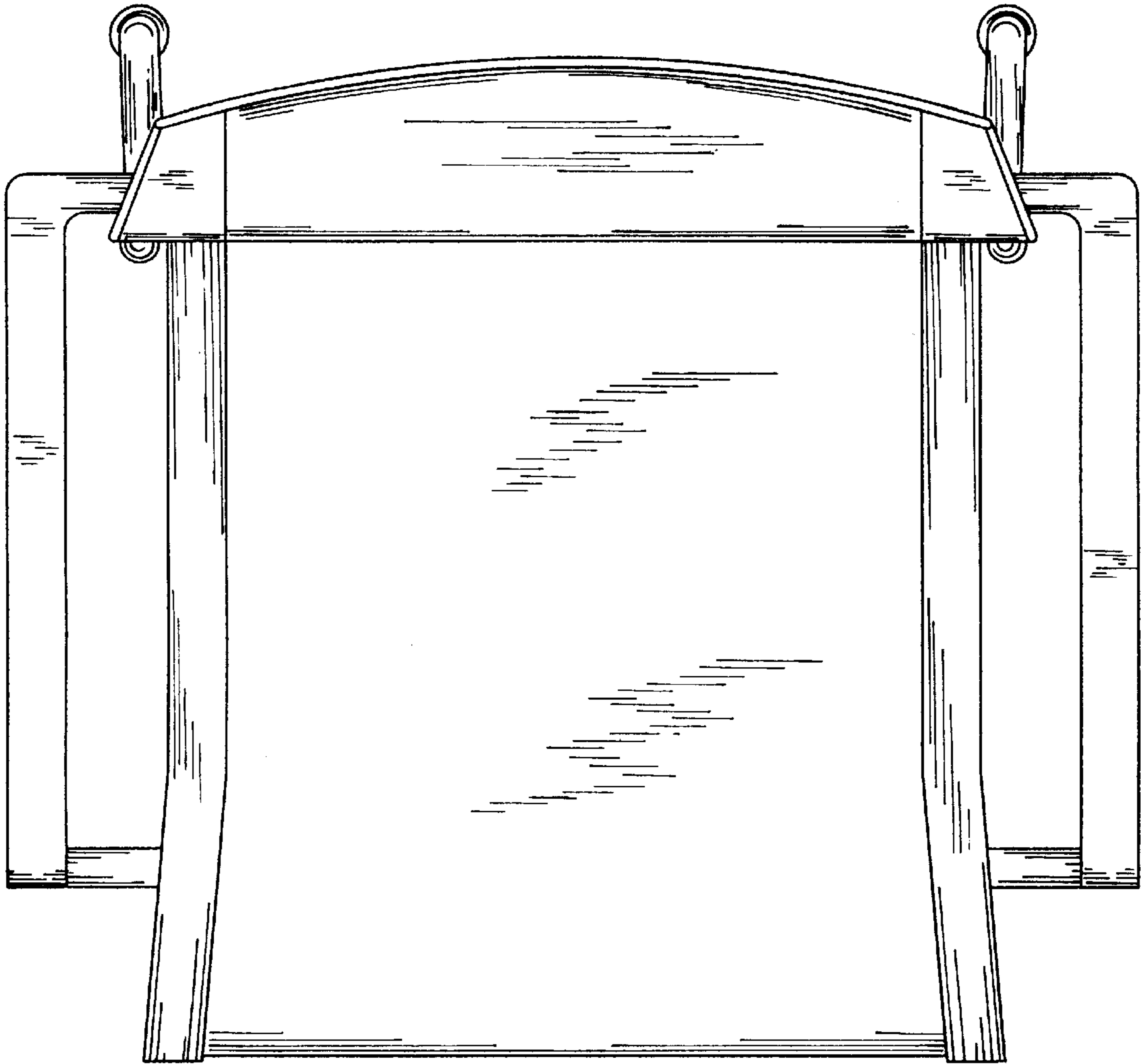

Fig. 13

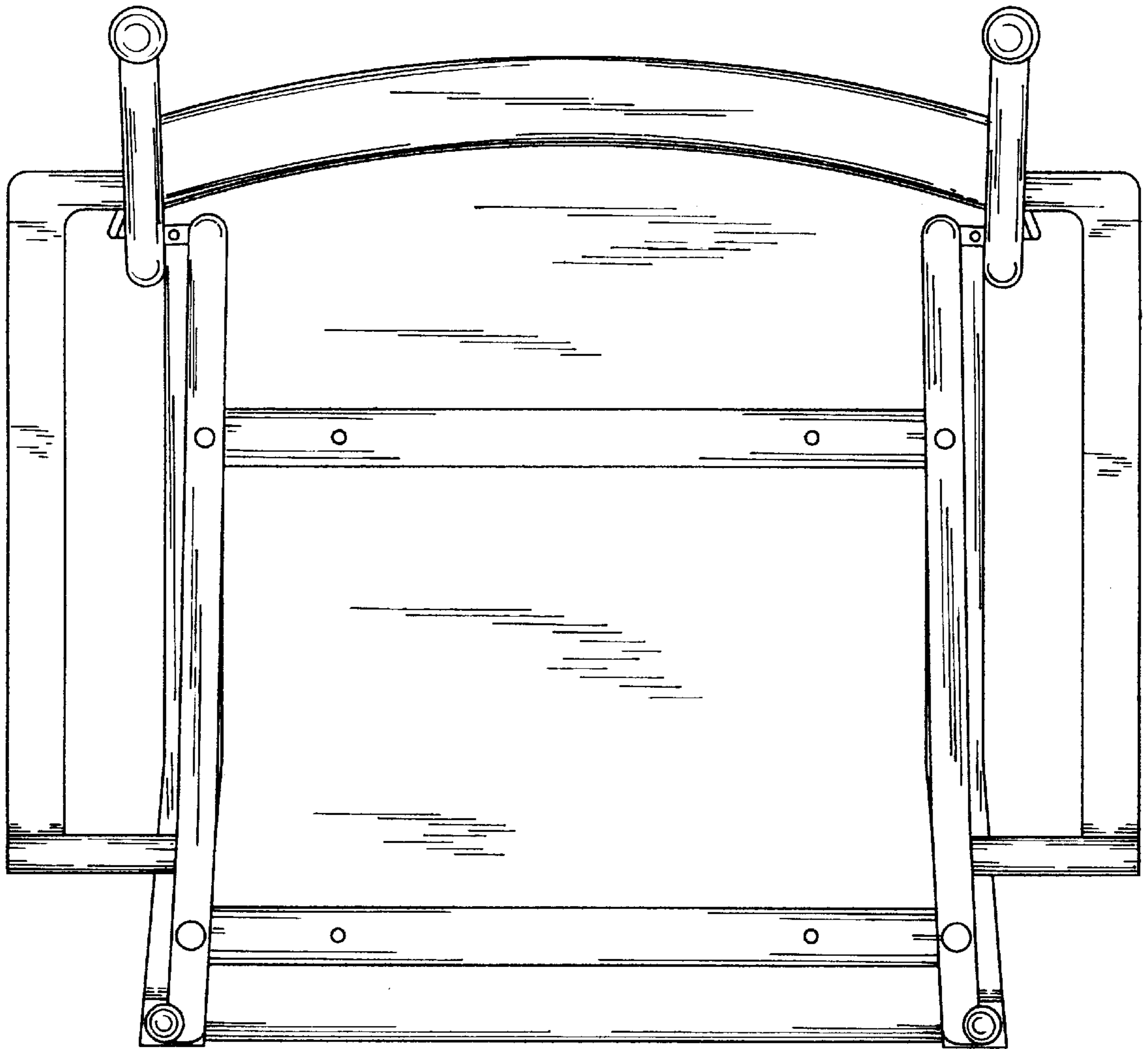

Fig. 14