



US00D449451B1

(12) **United States Design Patent**
Petner

(10) **Patent No.:** **US D449,451 S**

(45) **Date of Patent:** **** Oct. 23, 2001**

(54) **BRUSH WITH HANDLE**

(75) Inventor: **Robert E. Petner**, Burlington, NJ (US)

(73) Assignee: **Quickie Manufacturing Corporation**,
Cinnaminson, NJ (US)

(**) Term: **14 Years**

(21) Appl. No.: **29/109,807**

(22) Filed: **Aug. 24, 1999**

(51) **LOC (7) Cl.** **04-01**

(52) **U.S. Cl.** **D4/129; D4/138**

(58) **Field of Search** **D4/129, 130, 138;**
15/143.1, 159.1, 160, 186, 187; 16/110.1,
430

(56) **References Cited**

U.S. PATENT DOCUMENTS

- D. 329,752 * 9/1992 Murphy et al. D4/129
- D. 356,446 * 3/1995 Hoagland D4/138

OTHER PUBLICATIONS

O—Cedar/Vining Household Products Co. Hand and Nail
Brush—Item No. 309, p. CO-07, Aug. 1994.*

* cited by examiner

Primary Examiner—Alan P. Douglas

Assistant Examiner—Lavone Tabor

(74) *Attorney, Agent, or Firm*—Stuart M. Goldstein

(57) **CLAIM**

The ornamental design for a brush with handle, as shown
and described.

DESCRIPTION

FIG. 1 is an elevation view of the brush with handle.

FIG. 2 is an elevation view of the other side of the brush with
handle.

FIG. 3 is a top view of the brush with handle.

FIG. 4 is a bottom view of the other end of the brush with
handle.

FIG. 5 is a rear view of the brush with handle; and,

FIG. 6 is a front view of the brush with handle.

The broken line outline representing bristles, is for illustra-
tive purposes only and forms no part of the claimed design.

1 Claim, 2 Drawing Sheets

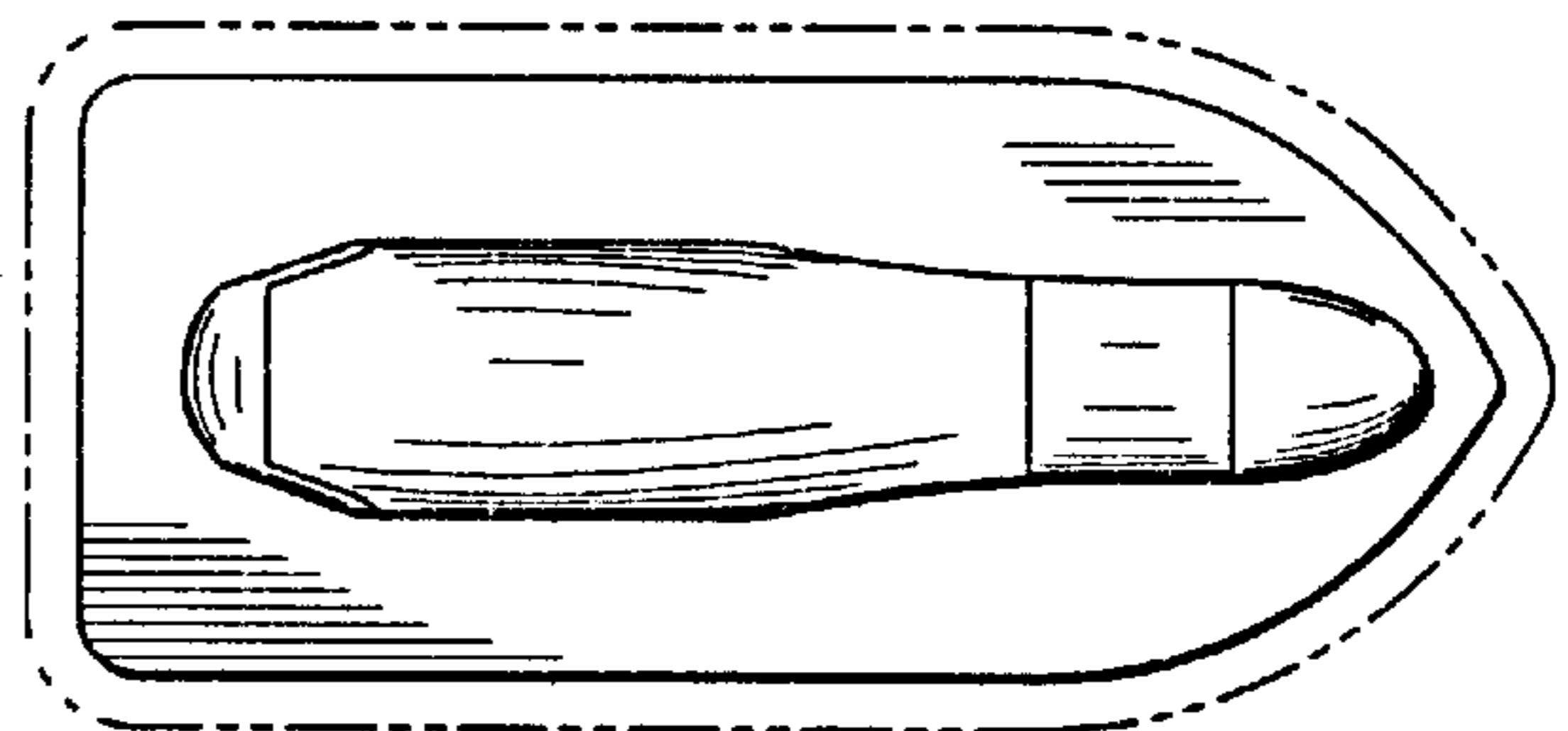
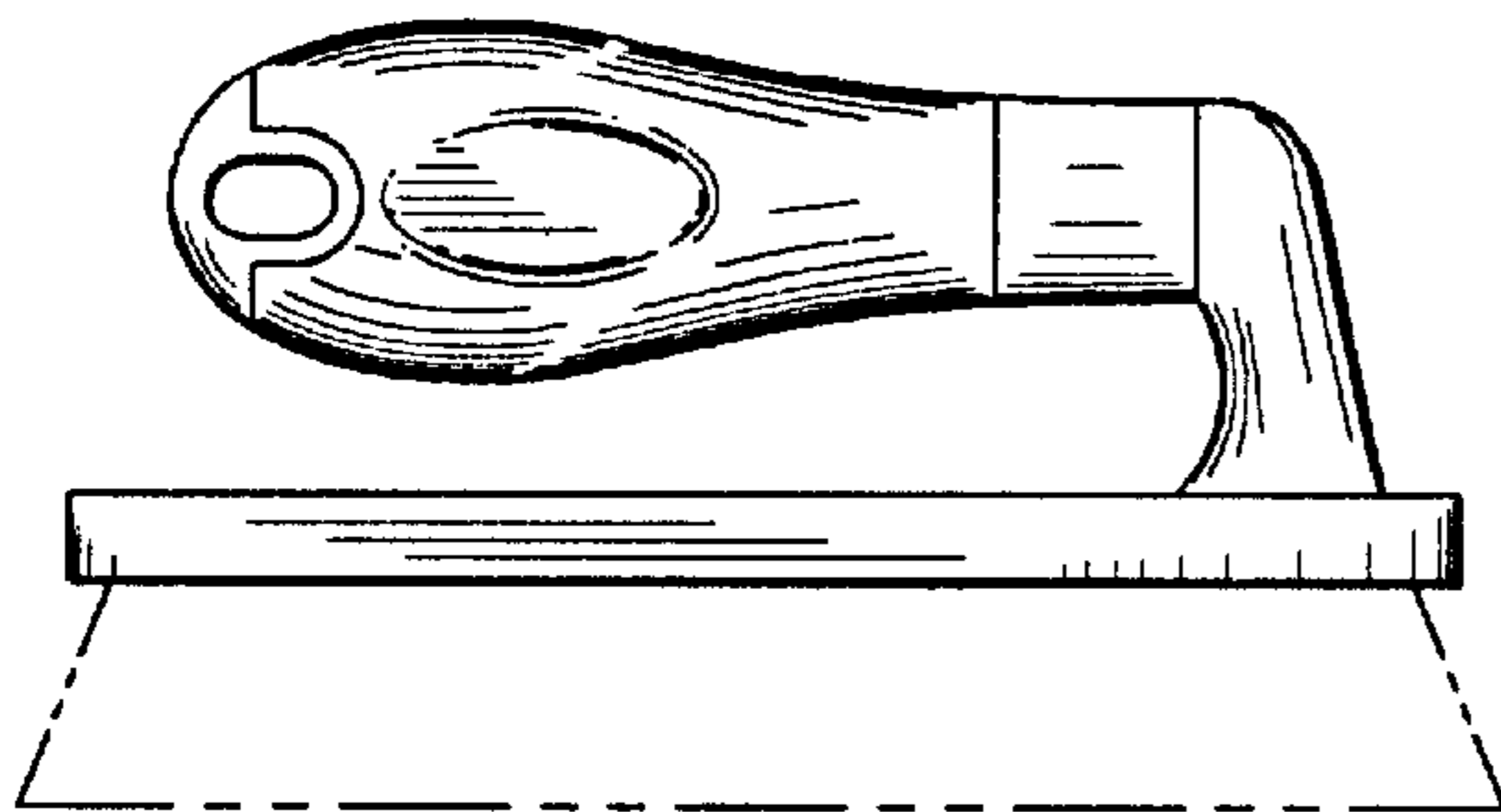

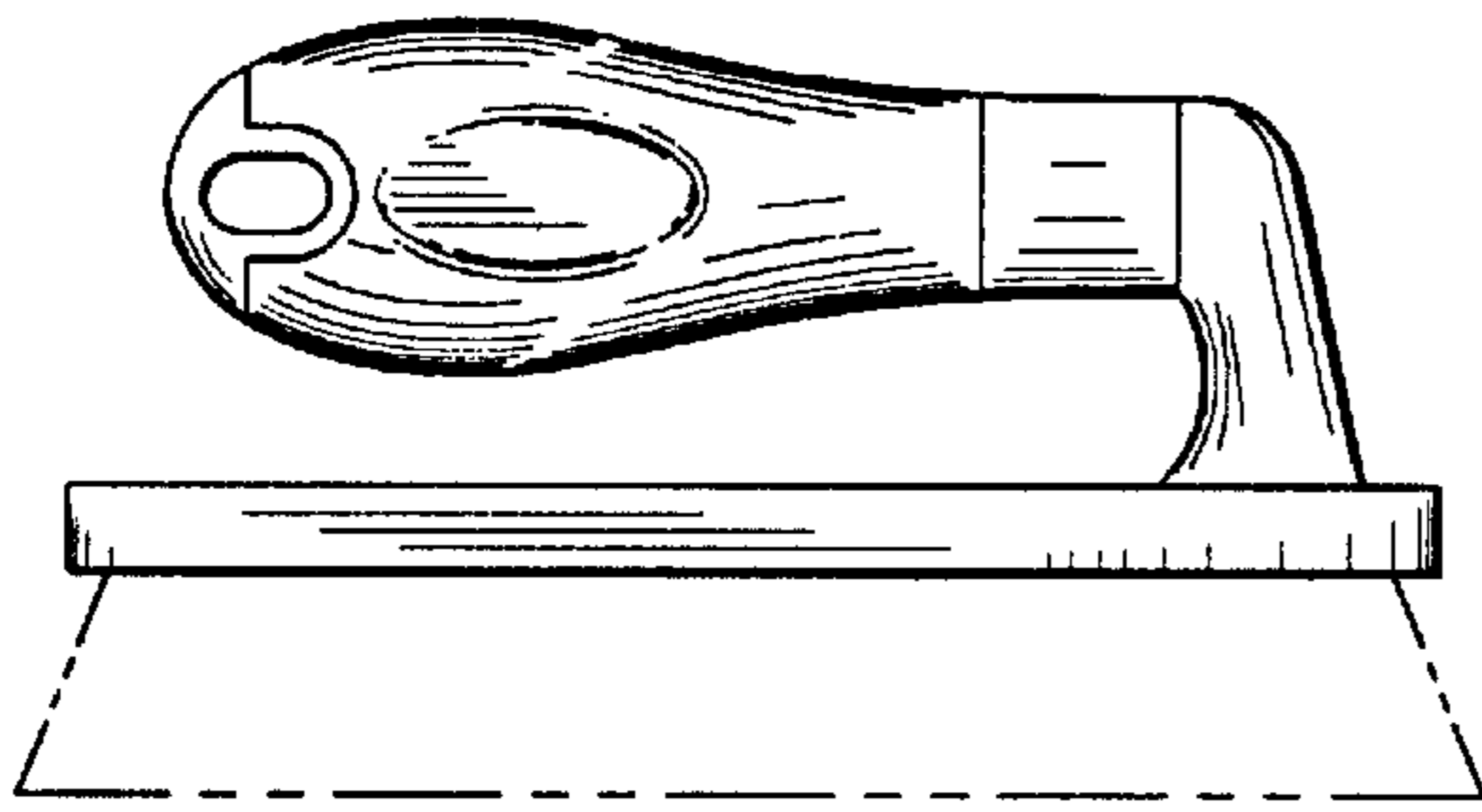

FIG. 1

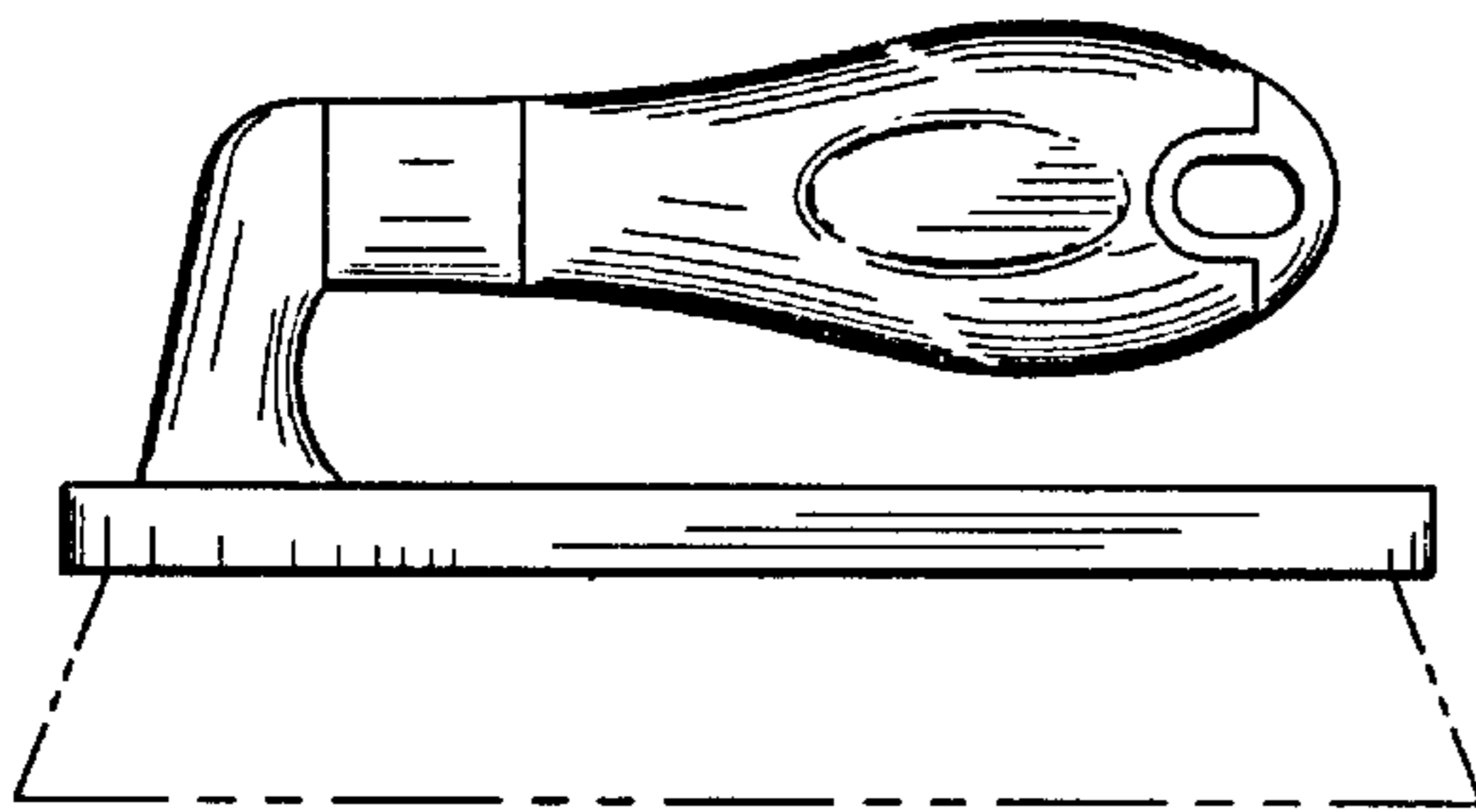

FIG. 2

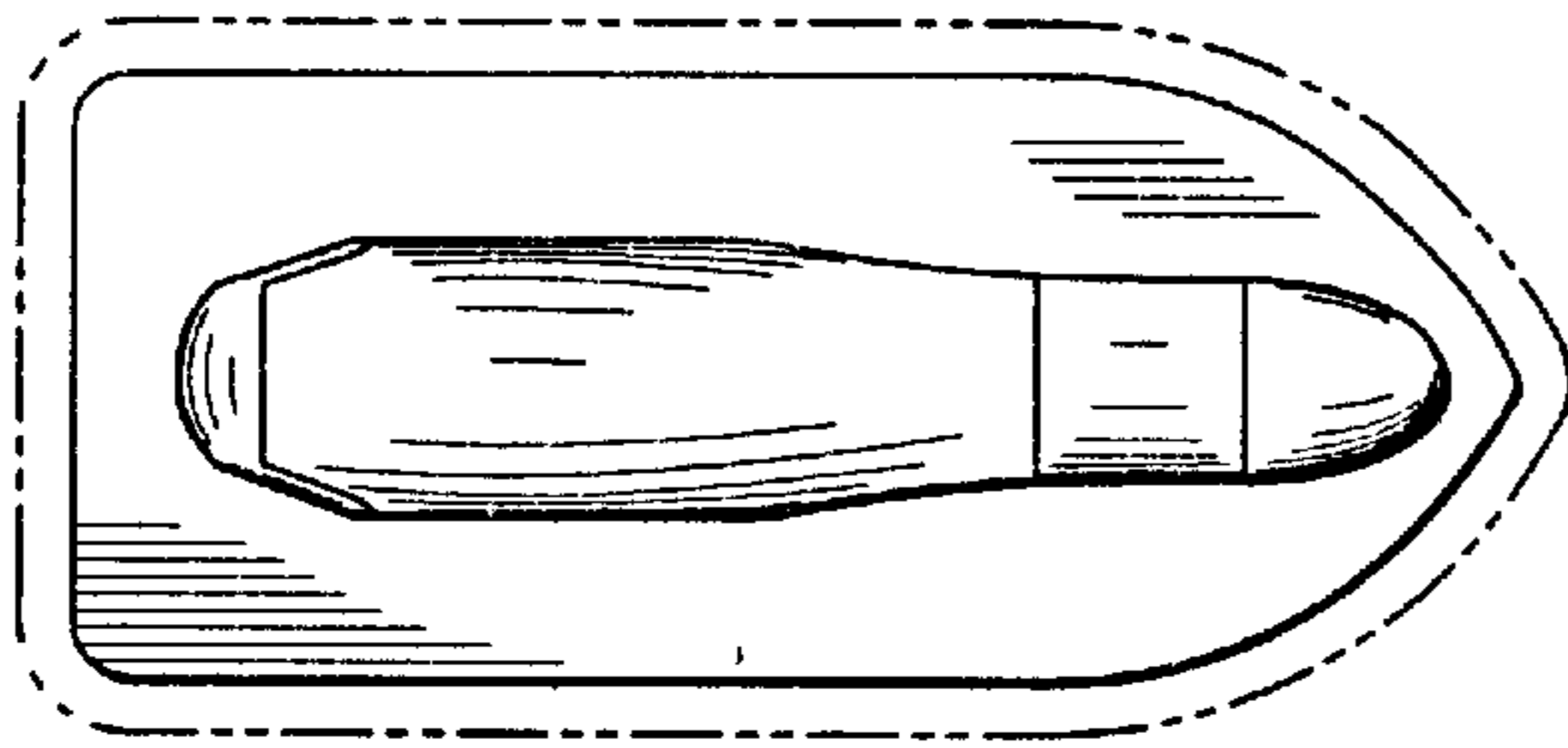

FIG. 3



FIG. 4

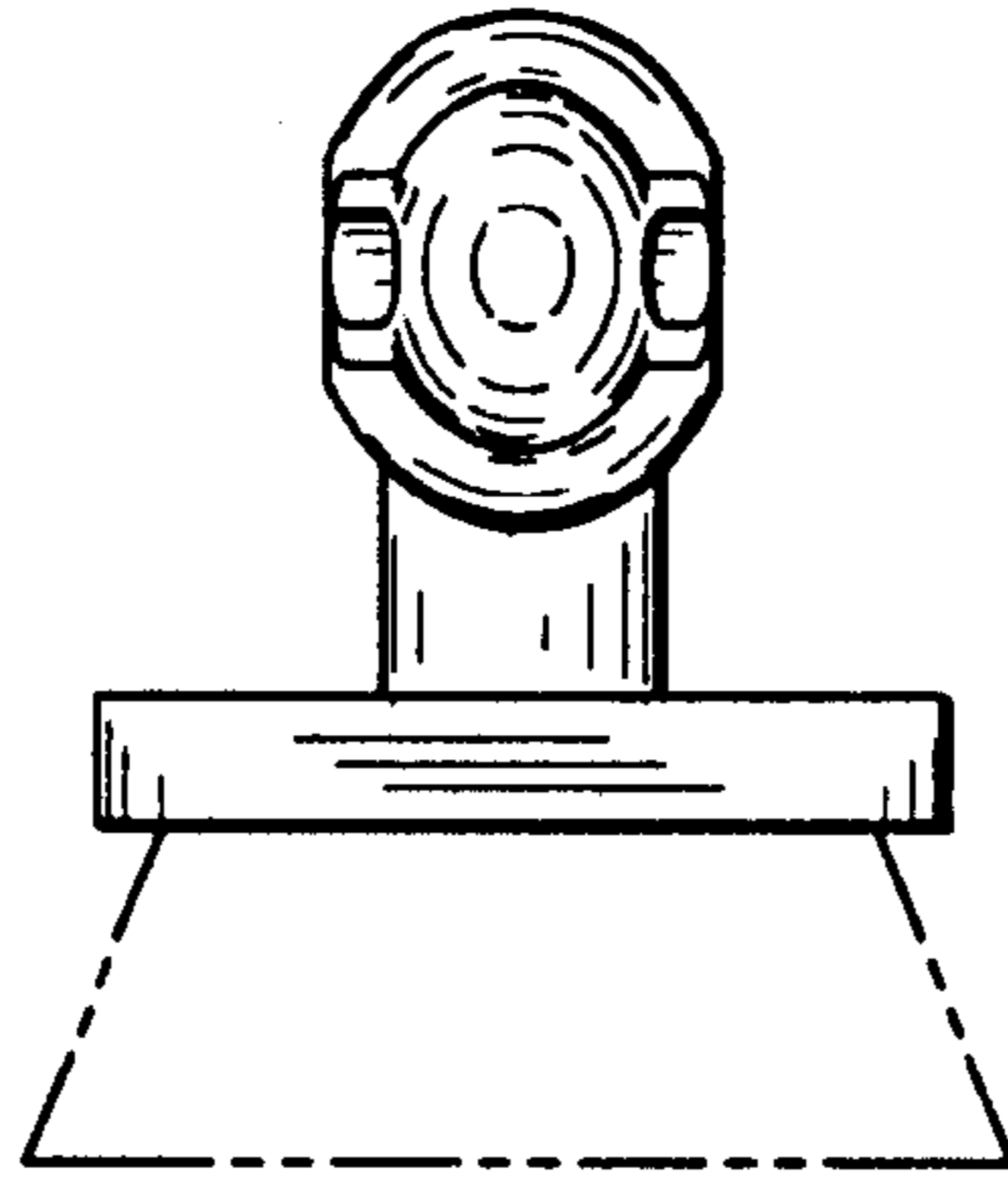

FIG. 5

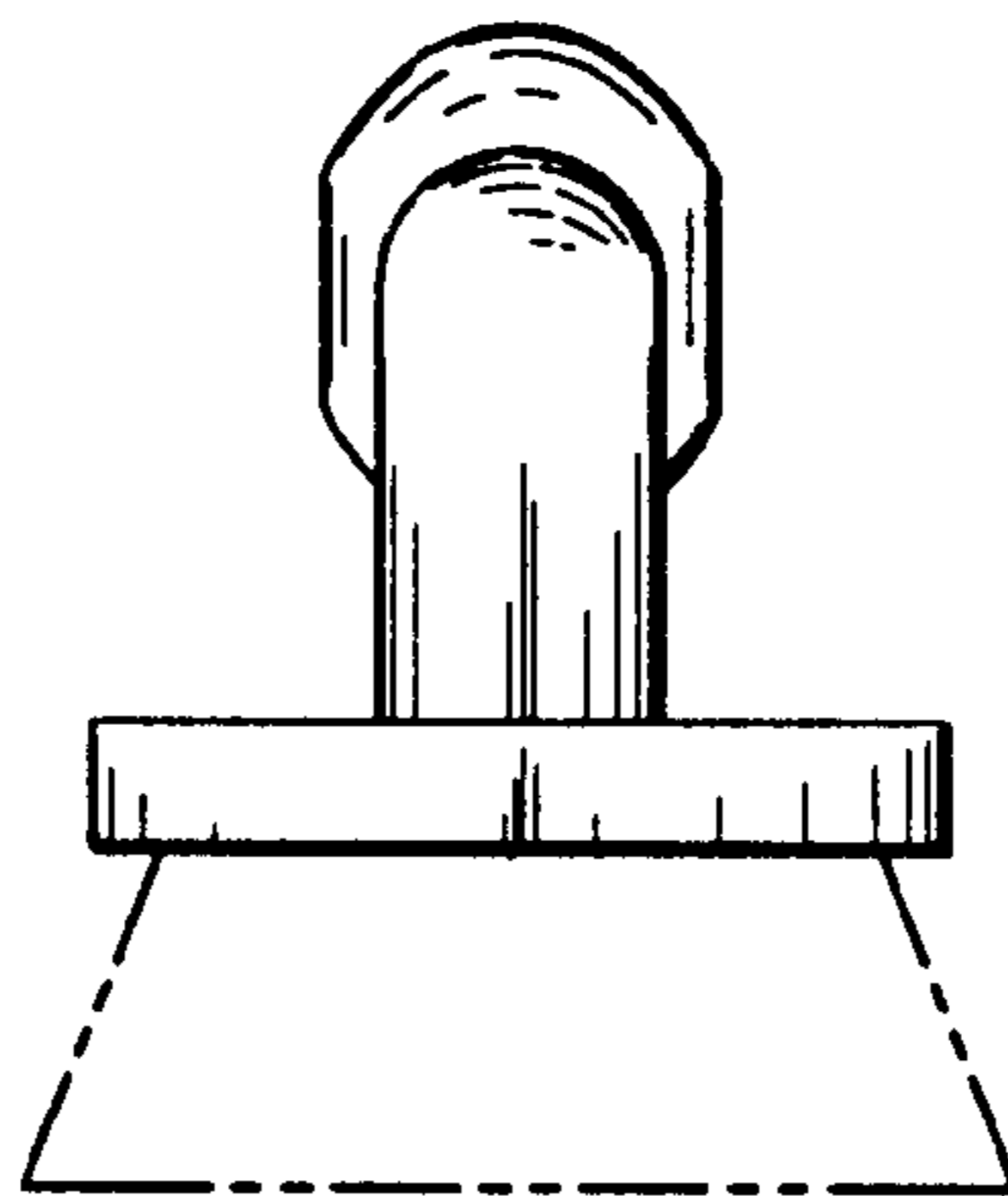

FIG. 6