



US00D449412B1

(12) **United States Design Patent**
Marasco

(10) **Patent No.:** **US D449,412 S**

(45) **Date of Patent:** **** Oct. 16, 2001**

- (54) **KNEELING DISK**
- (75) Inventor: **Angelo M. Marasco**, Waunakee, WI (US)
- (73) Assignee: **Alterra Holdings Corporation**, Portland, OR (US)
- (**) Term: **14 Years**
- (21) Appl. No.: **29/132,209**
- (22) Filed: **Nov. 6, 2000**

3,044,075	7/1962	Rawlings	2/22
4,043,424	8/1977	Carin	182/230
4,723,322	2/1988	Shelby	2/24
4,723,332	2/1988	Pourtau et al.	7/149
4,751,746	6/1988	Ekins	2/22
4,757,927	7/1988	Rutty	224/253
4,789,046	12/1988	McDowall	182/230
4,951,333	8/1990	Kaiser et al.	5/417
4,953,569	9/1990	Lonardo	128/892
5,125,479	6/1992	Nemes et al.	182/230
5,220,691	6/1993	Wiegers	2/24
5,226,384	7/1993	Jordan	5/420 X
5,405,312	4/1995	Jacobs	602/5
5,429,541	7/1995	Landon	5/417 X
5,572,758	11/1996	Merritt	5/420 X
5,791,611	10/1999	Rosengren	5/417 X
5,794,275	8/1998	Donzis	2/455

Related U.S. Application Data

- (62) Division of application No. 29/103,588, filed on Apr. 16, 1999, now Pat. No. Des. 434,534.
- (51) **LOC (7) Cl.** **02-04**
- (52) **U.S. Cl.** **D29/121.1**
- (58) **Field of Search** D29/100, 121.1, D29/122; D24/190; 2/22-24, 62, 267; 5/417-420, 657.5, 656, 907; D6/330, 582, 583, 585, 592

Primary Examiner—Louis S. Zarfaz
Assistant Examiner—Robert A. Delehanty
 (74) *Attorney, Agent, or Firm*—Foley & Lardner

(57) **CLAIM**

I claim the ornamental design for the kneeling disk, as shown and described.

DESCRIPTION

FIG. 1 is a perspective of a kneeling disk;
 FIG. 2 is a top view of the kneeling disk shown in FIG. 1;
 FIG. 3 is a bottom view of the kneeling disk shown in FIG. 1;
 FIG. 4 is a front view of the kneeling disk shown in FIG. 1;
 FIG. 5 is a right side view of the kneeling disk shown in FIG. 1;
 FIG. 6 is a back view of the kneeling disk shown in FIG. 1; and,
 FIG. 7 is a left side view of the kneeling disk shown in FIG. 1.
 The broken lines in FIGS. 1-7 showing portions of the upper edge of the kneeling disk and portions of a soft cushion are for illustrative purposes only and form no part of the claimed design.

1 Claim, 2 Drawing Sheets

(56) **References Cited**

U.S. PATENT DOCUMENTS

D. 187,639	4/1960	Timmons	D7/388
D. 322,146	12/1991	Anderson	D29/10
D. 335,000	4/1993	Johnson	D29/10
D. 341,680	11/1993	Levine	D29/10
D. 376,481	12/1996	Bidwell et al.	D6/330
378,369	2/1888	Hyer	5/417
D. 385,670	10/1997	Oetting	D29/121
D. 434,534	11/2000	Marasco	D29/121.1
718,517	1/1903	Perry	5/420
889,756	6/1908	Bukacek	5/420
1,454,401	5/1923	O'Neill	182/129
1,896,561	2/1933	Ruth	2/24
1,976,170	10/1934	Hoover et al.	182/230
2,195,817	4/1940	Johnson	2/24
2,464,341	3/1949	Ostlung	280/18.1
2,826,423	3/1958	Erickson	D12/11 X

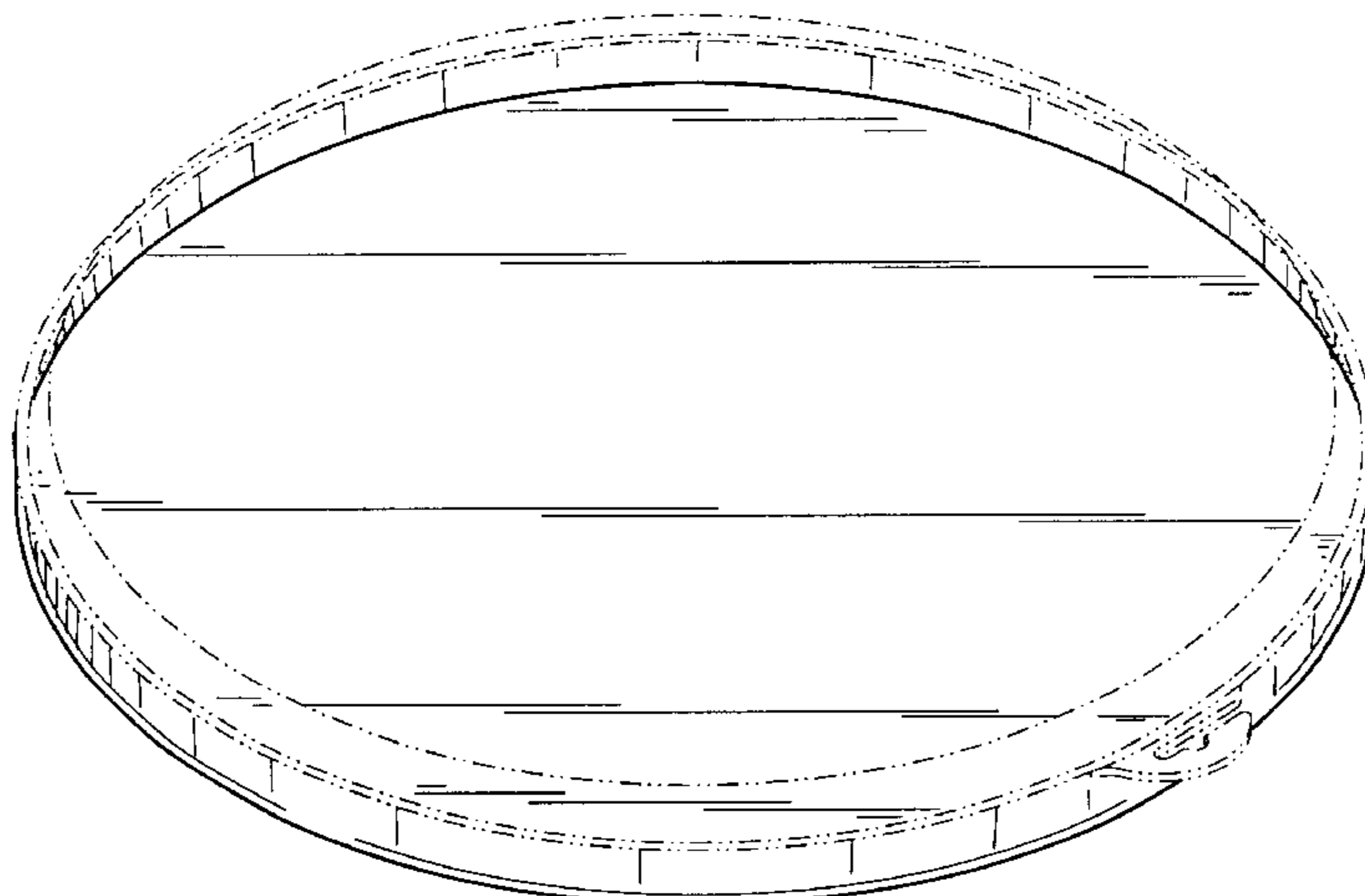

FIG. 1

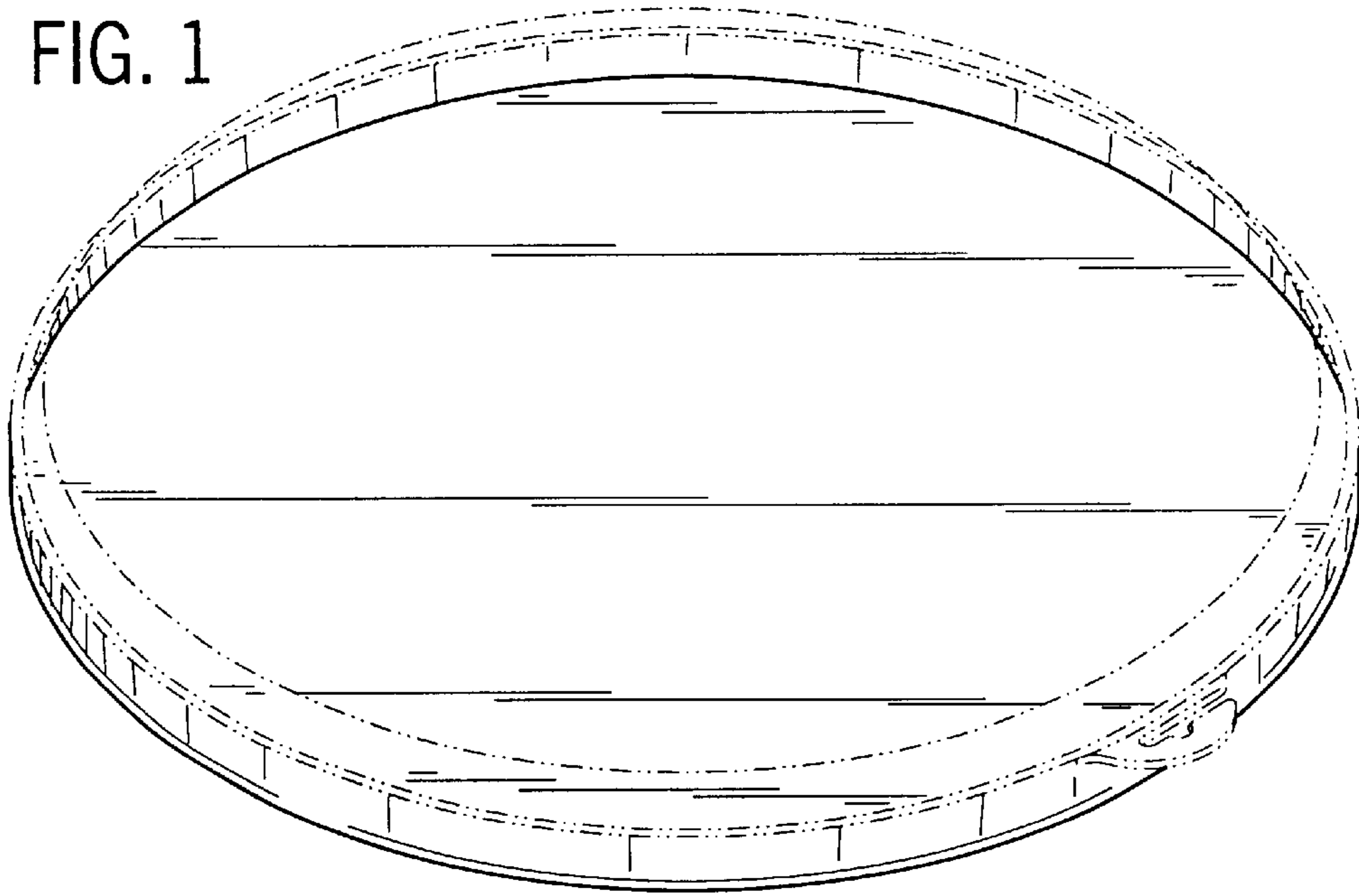

FIG. 2

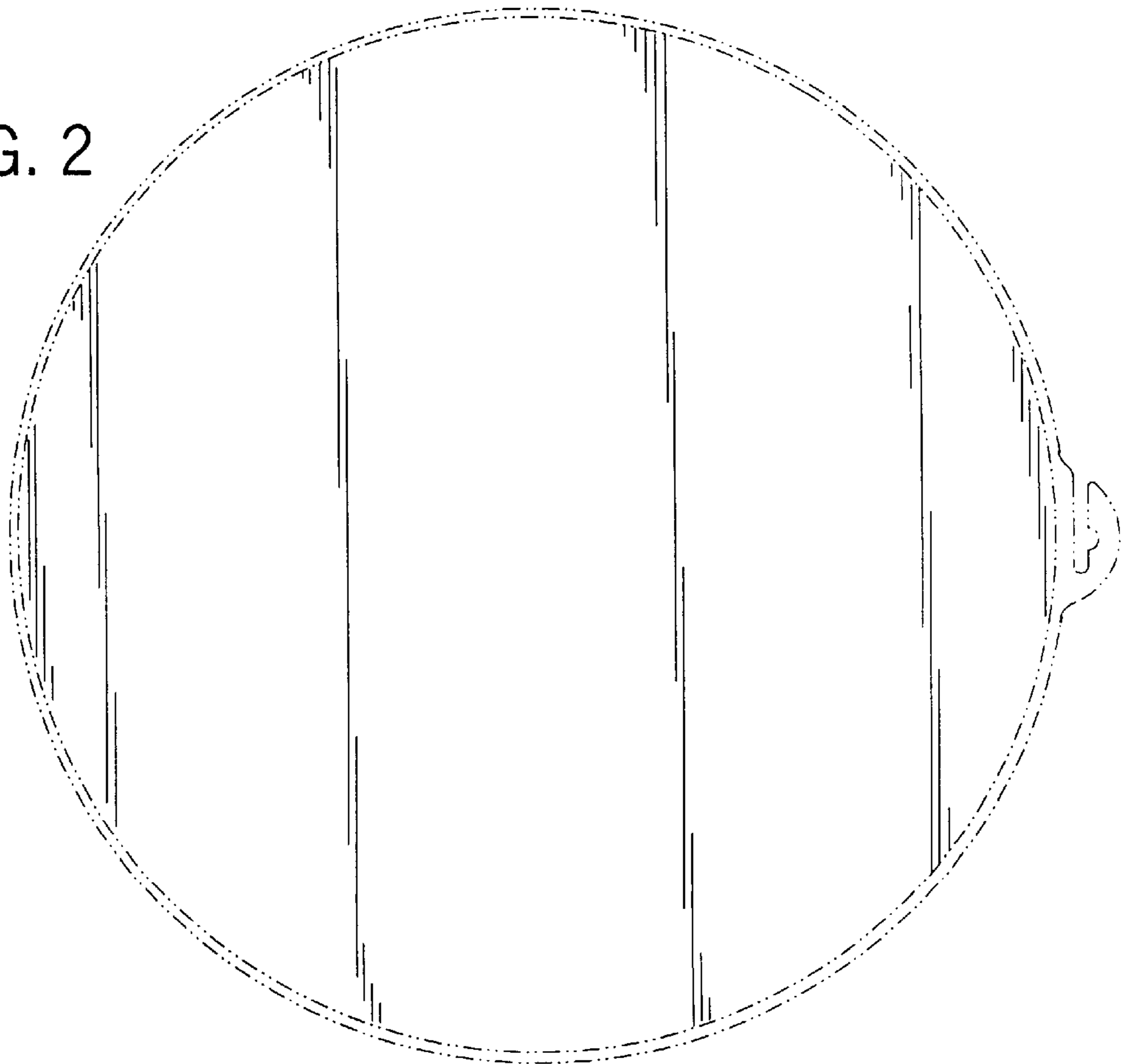

FIG. 3

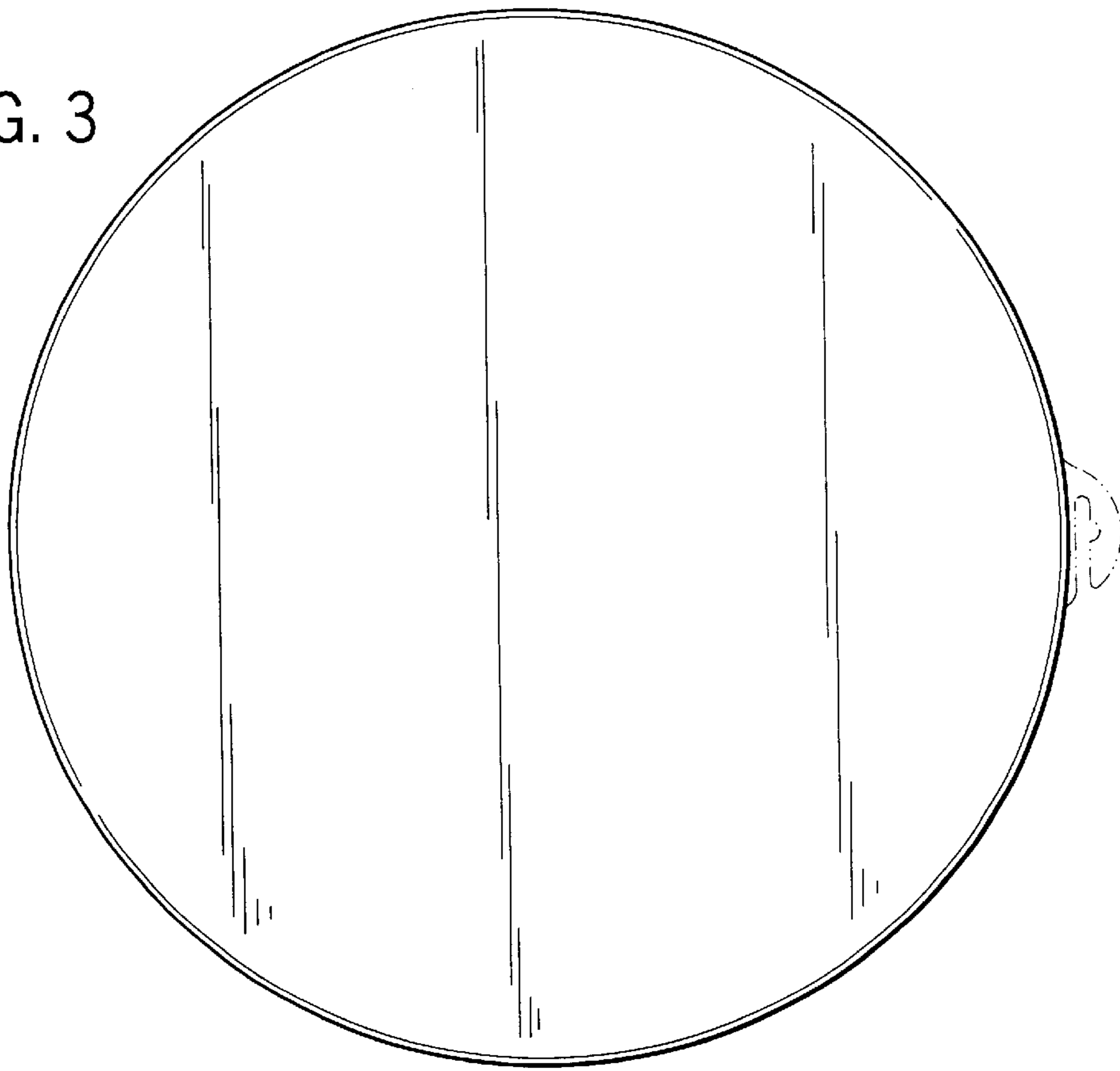

FIG. 4

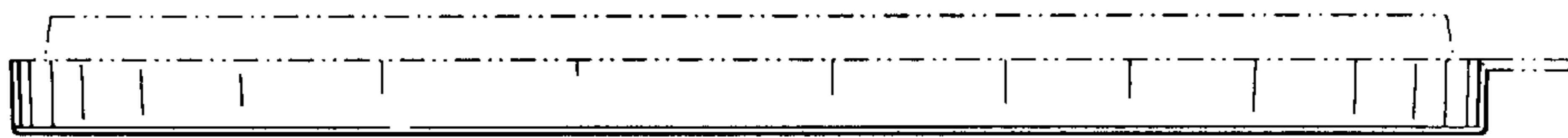

FIG. 5

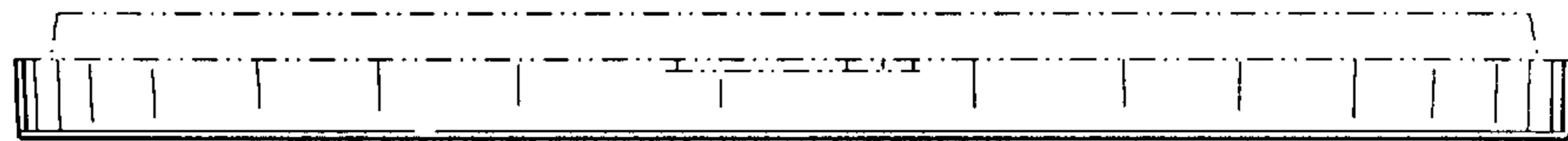

FIG. 6

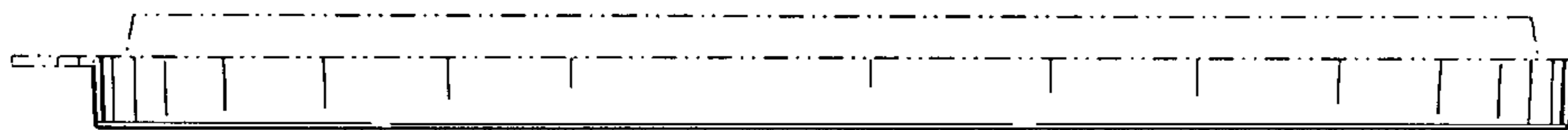

FIG. 7

