



US00D449365B1

(12) **United States Design Patent**
Bambacigno

(10) **Patent No.:** **US D449,365 S**

(45) **Date of Patent:** **** Oct. 16, 2001**

(54) **SIMULATED LIVE BAIT FISHING LURE**

3,175,324 * 3/1965 Blackwell 43/42.32

(75) Inventor: **John A. Bambacigno**, Grangeville, ID (US)

OTHER PUBLICATIONS

Eppinger—America's Family of Fishing Lures, Dardevle Imp Fishing Lure, Jul. 1996.*

(73) Assignee: **W. James Spickelmire, et al.**, Grangeville, ID (US)

* cited by examiner

(**) Term: **14 Years**

Primary Examiner—Catherine R. Oliver

(21) Appl. No.: **29/130,885**

(74) *Attorney, Agent, or Firm*—Wells, St. John, Roberts, Gregory & Matkin

(22) Filed: **Oct. 10, 2000**

(57) **CLAIM**

(51) **LOC (7) Cl.** **22-05**

The ornamental design for a simulated live bait fishing lure, as shown and described.

(52) **U.S. Cl.** **D22/129**

(58) **Field of Search** D22/125-134;
43/42.18, 42.39, 42.32, 42.37, 42.45, 43.16,
42.52, 42.5, 42.33

DESCRIPTION

(56) **References Cited**

U.S. PATENT DOCUMENTS

D. 330,581	*	10/1992	Rowe	D22/128
D. 374,907	*	10/1996	Ketchum	D22/129
D. 411,869		7/1999	Tirone, Jr.	D22/126
D. 412,733	*	8/1999	Cox	D22/129
D. 418,574		1/2000	Rowh	D22/129
D. 421,638		3/2000	Yount	D22/126
2,516,434	*	7/1950	Swan	43/42.18

FIG. 1 is a perspective view of a simulated live bait fishing lure showing my new design;
FIG. 2 is a top plan view thereof;
FIG. 3 is a bottom plan view thereof;
FIG. 4 is a side elevation view thereof, the opposite side being substantially a mirror image;
FIG. 5 is a front elevation view thereof;
FIG. 6 is a rear elevation view thereof; and,
FIG. 7 is a sectional view taken substantially along line 7—7 in FIG. 4.

1 Claim, 3 Drawing Sheets

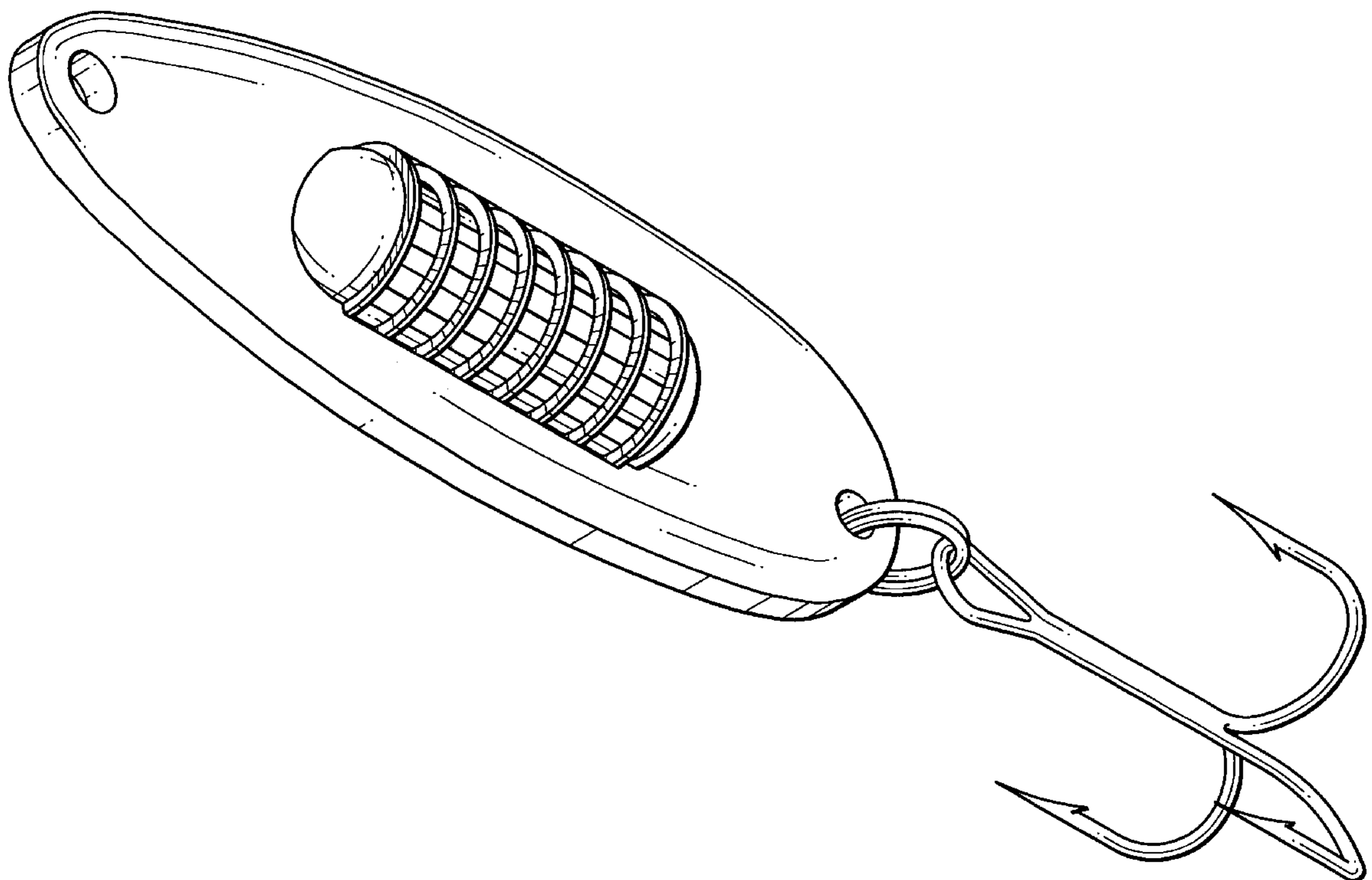

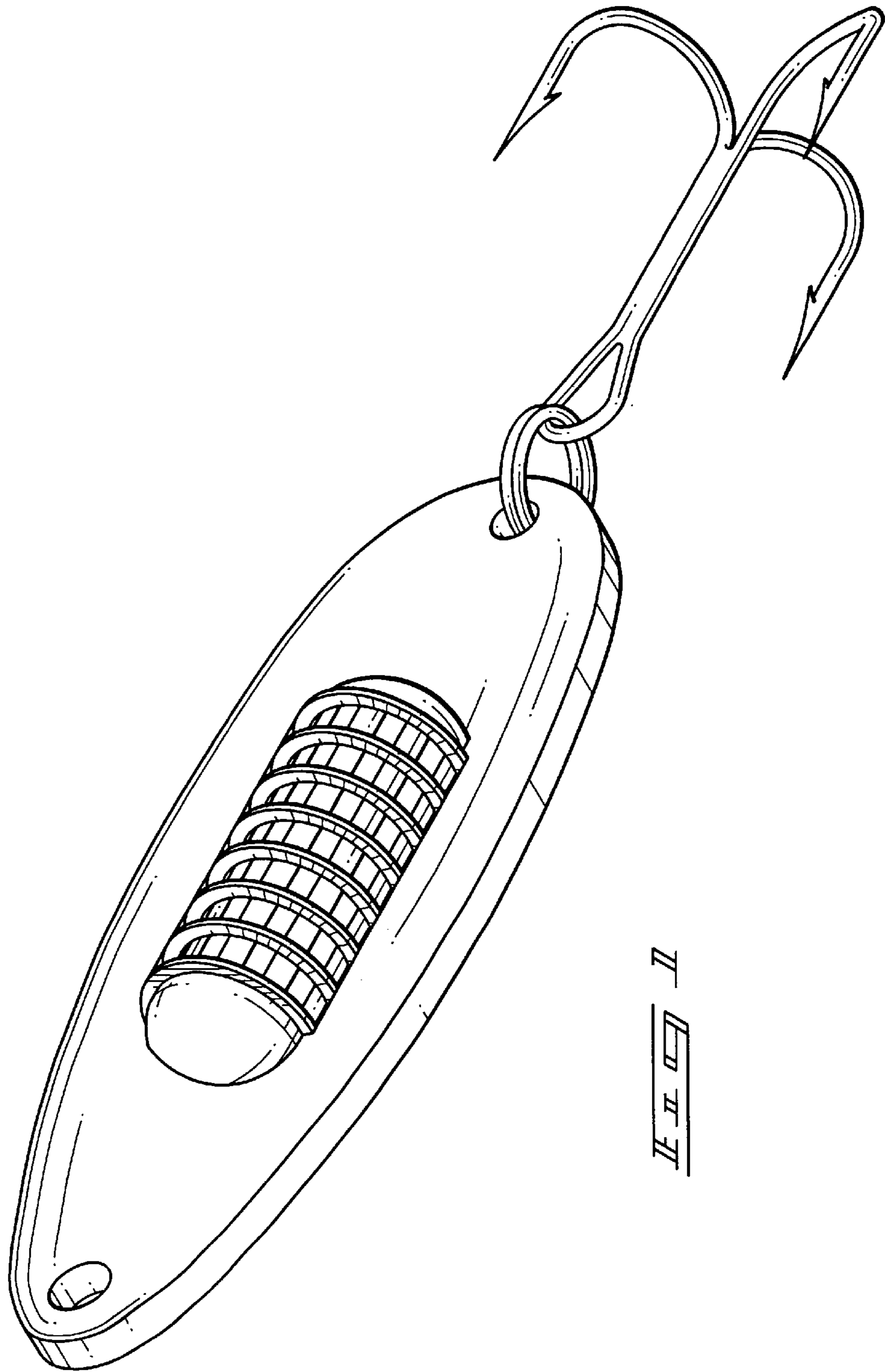

FIG. 1

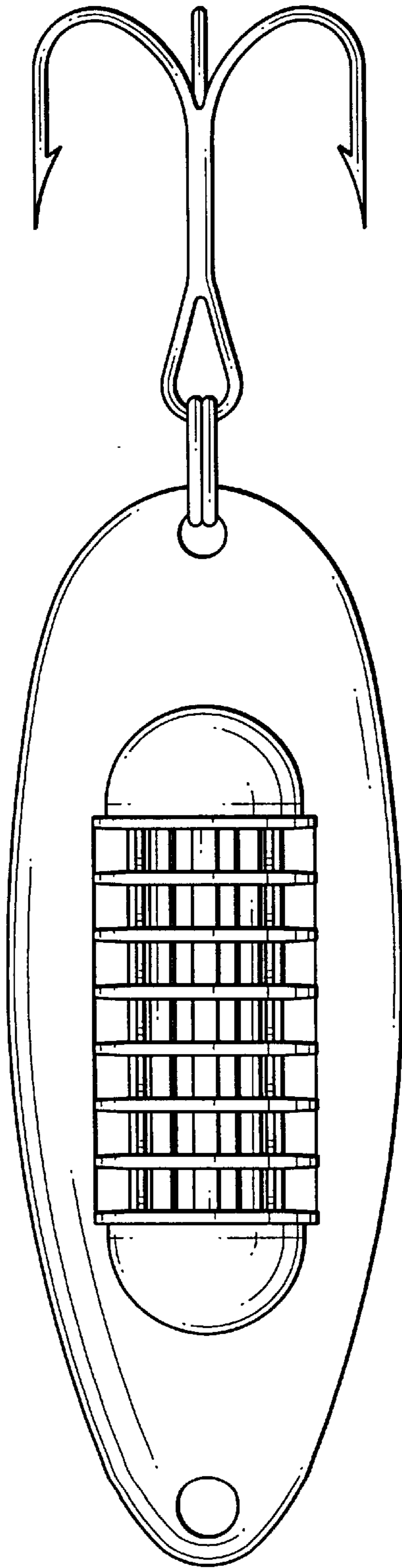

FIG. 2

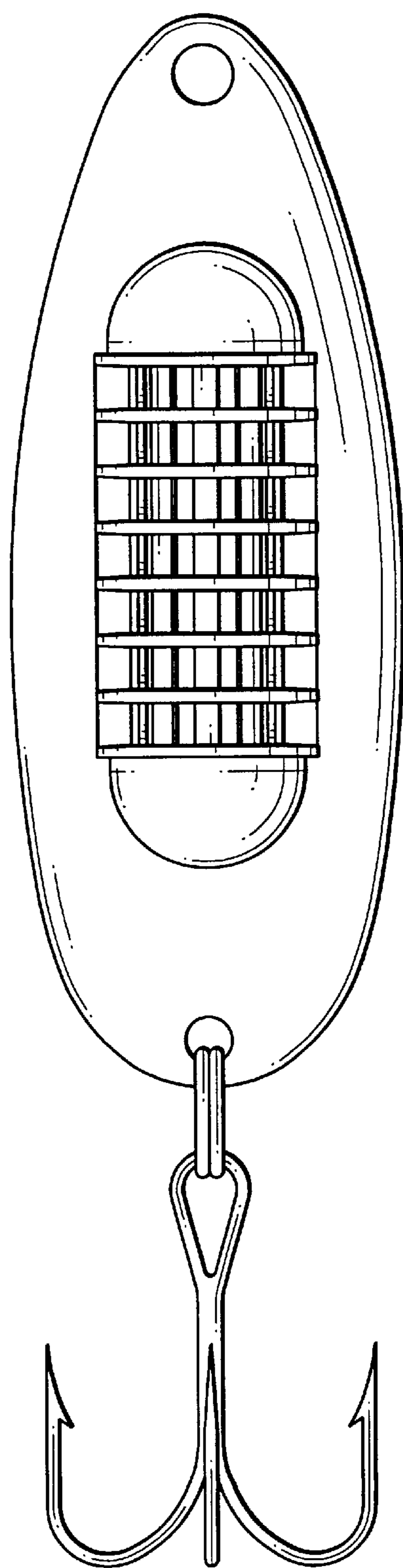
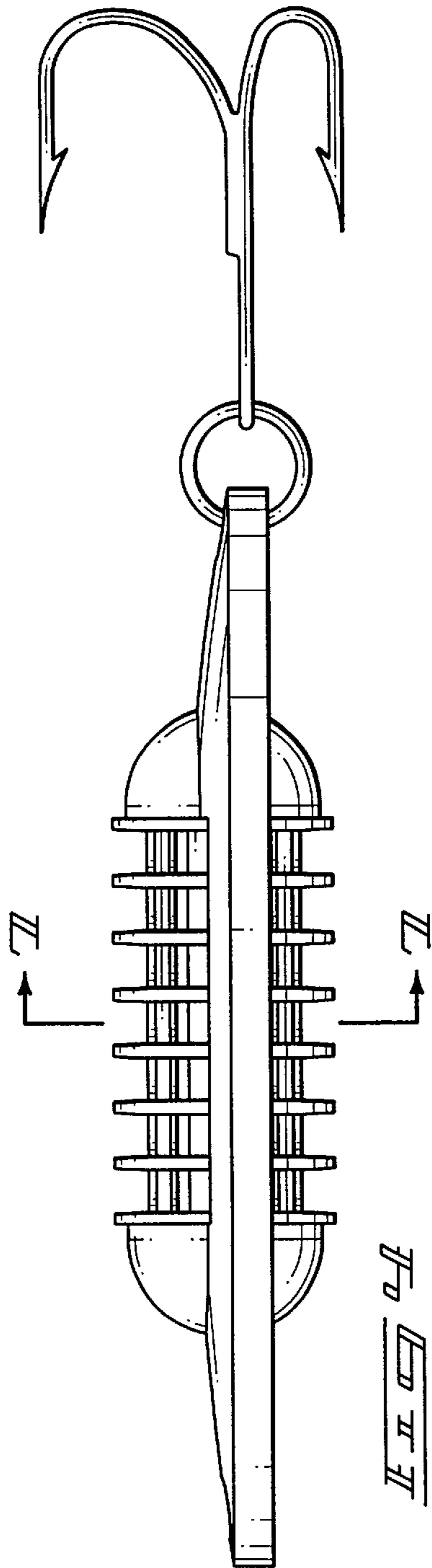
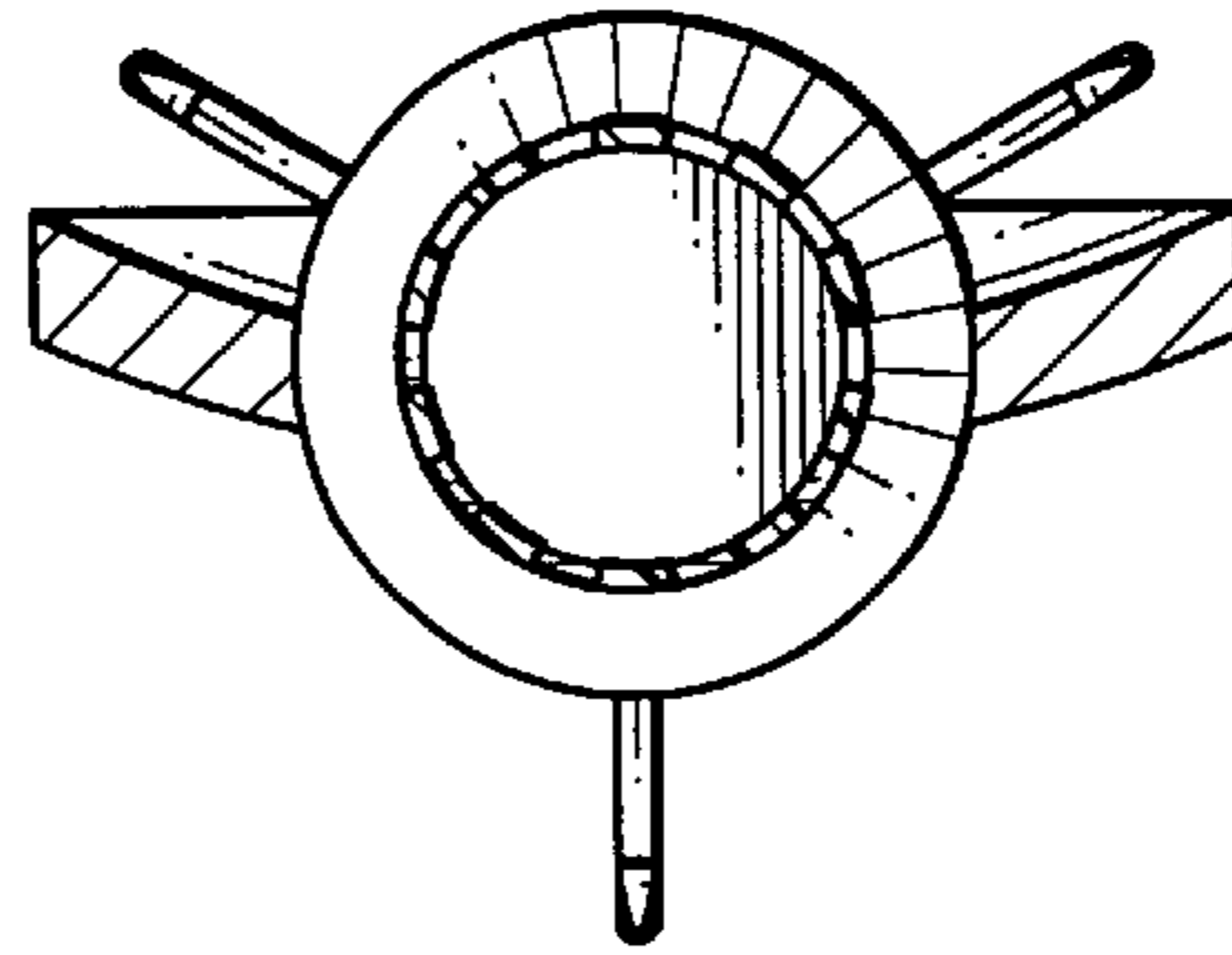

FIG. 1



II



II

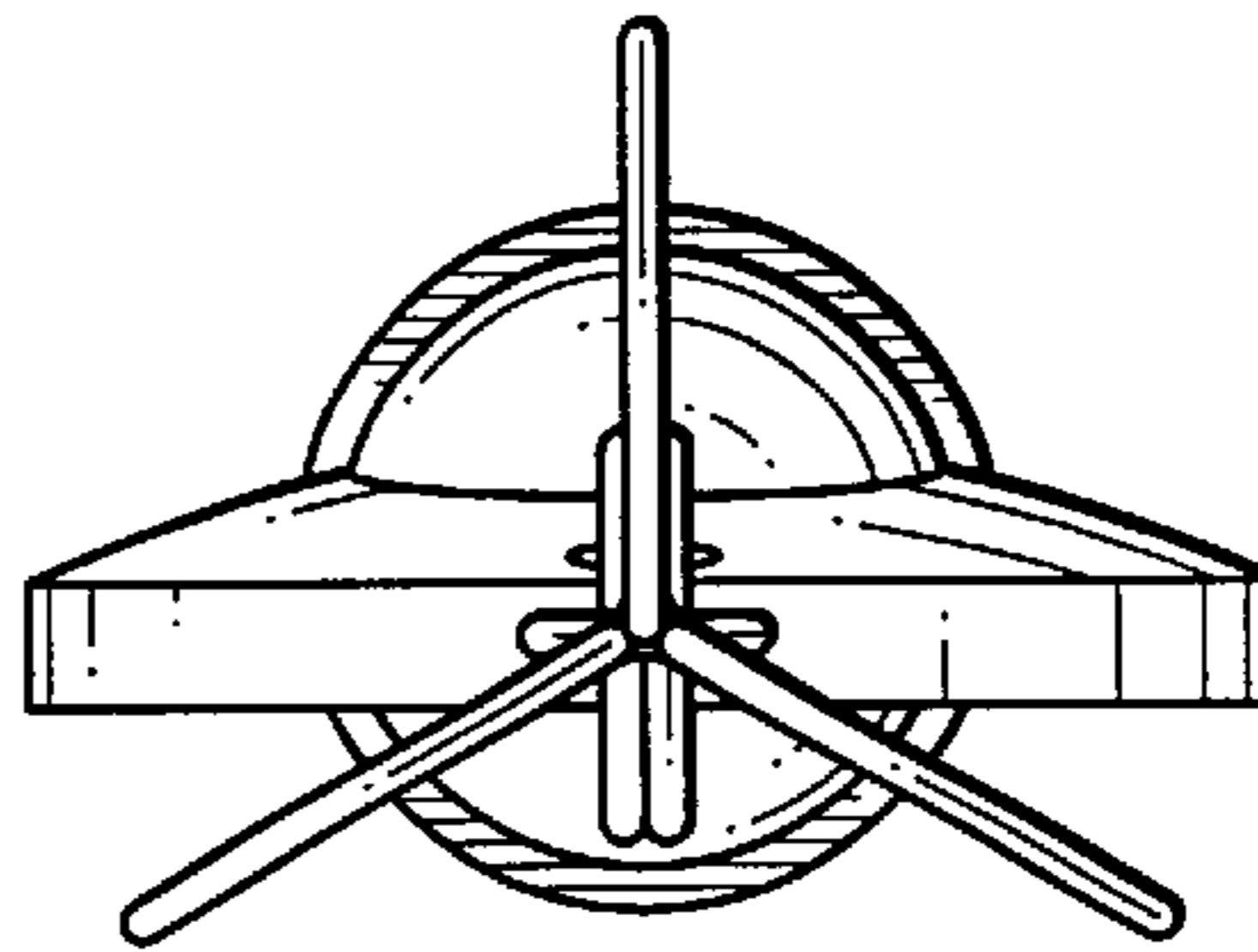

II

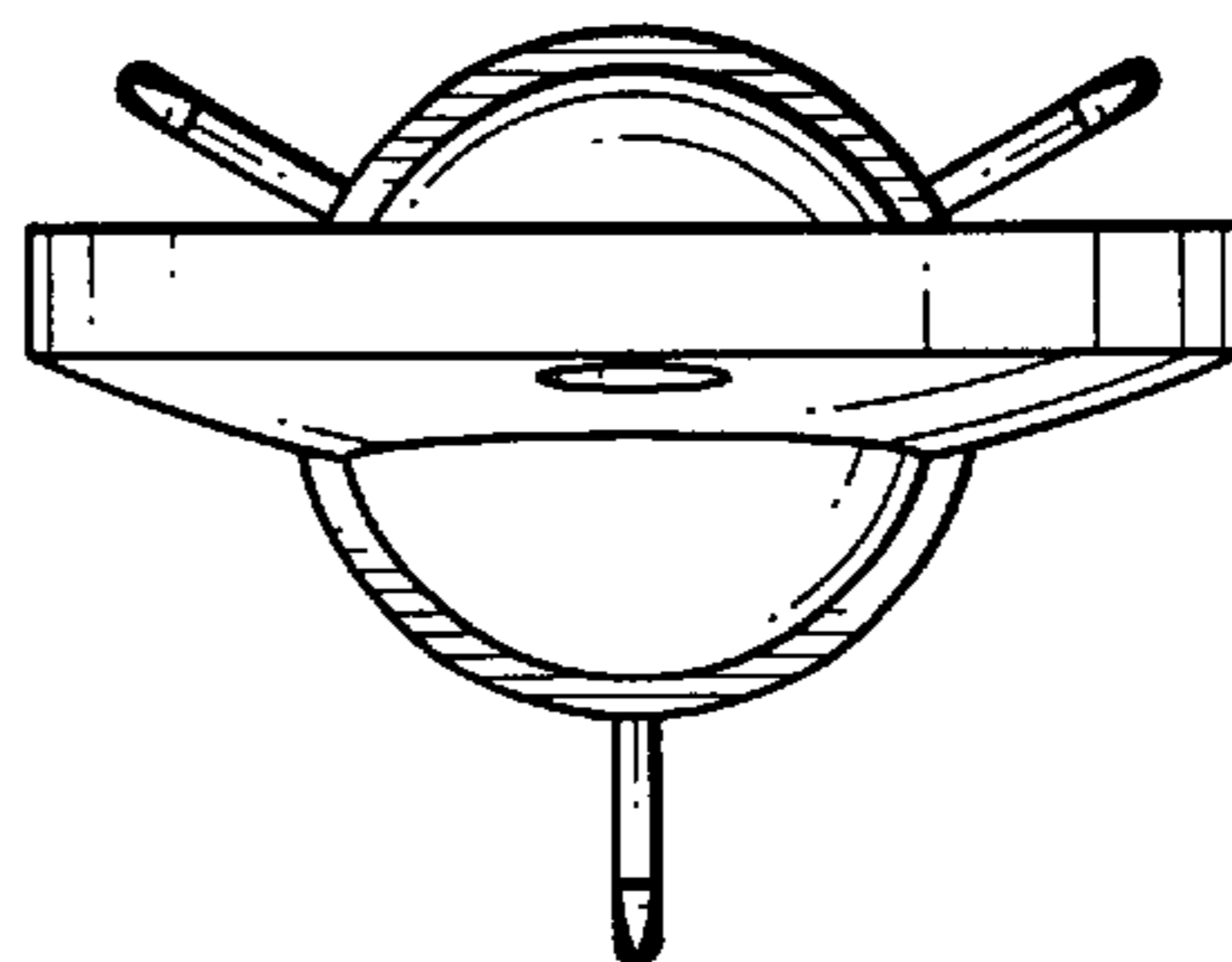

II