



US00D449334B1

(12) **United States Design Patent**
Dwyer et al.

(10) **Patent No.:** **US D449,334 S**

(45) **Date of Patent:** **** Oct. 16, 2001**

(54) **INKJET PRINTER**

(75) Inventors: **Daniel R. Dwyer**, Battle Ground, WA (US); **Masahita Cho**; **Richard Jeli**, both of Portland, OR (US); **Stephen R. Brown**, Portland, OR (US); **Tod A. Kinsley**, Tigard, OR (US); **Jeffrey J. Grange**, Brush Prairie, WA (US)

(73) Assignee: **Hewlett-Packard Company**, Palo Alto, CA (US)

(**) Term: **14 Years**

(21) Appl. No.: **29/131,630**

(22) Filed: **Oct. 25, 2000**

(51) **LOC (7) Cl.** **14-02**

(52) **U.S. Cl.** **D18/55**

(58) **Field of Search** D18/36-39, 50, D18/54-55; D14/462-470; 400/613, 613.1-613.4, 691-694, 690.1-690.4

(56) **References Cited**

U.S. PATENT DOCUMENTS

D. 373,380	*	9/1996	Dwyer et al.	D18/55
D. 382,894	*	8/1997	Berriman et al.	D18/55
D. 390,257	*	2/1998	Dwyer et al.	D18/55
D. 406,273	*	3/1999	Dwyer et al.	D18/55
D. 414,799	*	10/1999	Cook et al.	D18/55
D. 428,052	*	7/2000	Dwyer et al.	D18/55

D. 429,279	*	8/2000	Dwyer et al.	D18/55
D. 429,759	*	8/2000	Dwyer et al.	D18/55
D. 430,896	*	9/2000	Wong et al.	D18/55
D. 439,274	*	3/2001	Dwyer et al.	D18/55
D. 443,296	*	6/2001	Dwyer et al.	D18/55
6,152,630	*	11/2000	Scarton et al.	400/693

* cited by examiner

Primary Examiner—Cathy Anne MacCormac

(74) *Attorney, Agent, or Firm*—Flory L. Martin

(57) **CLAIM**

The ornamental design for an inkjet printer, substantially as shown and described.

DESCRIPTION

FIG. 1 is a perspective view of a first embodiment of an inkjet printer in accordance with the present invention; FIG. 2 is a front elevational view thereof; FIG. 3 is a right side elevational view thereof, with the left side elevational view being a mirror image of FIG. 3; FIG. 4 is a rear elevational view thereof; FIG. 5 is top plan view thereof, with the bottom plan view being omitted because it has no ornamental value; FIG. 6 is a perspective view of a second embodiment of FIG. 1, the difference being the opening in the paper tray exposing a photo media loading button; and, FIG. 7 is a top plan view of the second embodiment of FIG. 6, with the remaining views being the same as shown for the first embodiment.

1 Claim, 7 Drawing Sheets

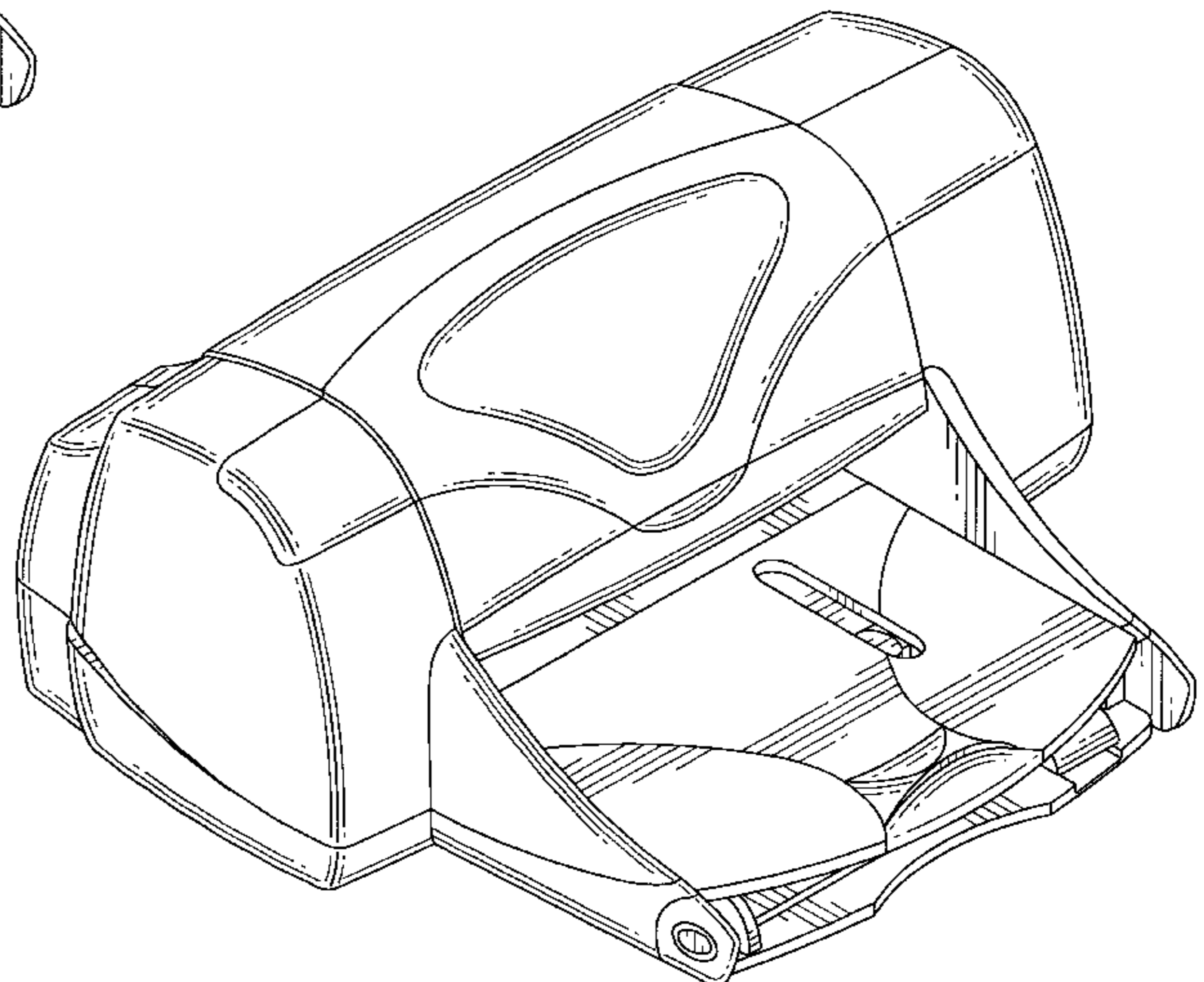
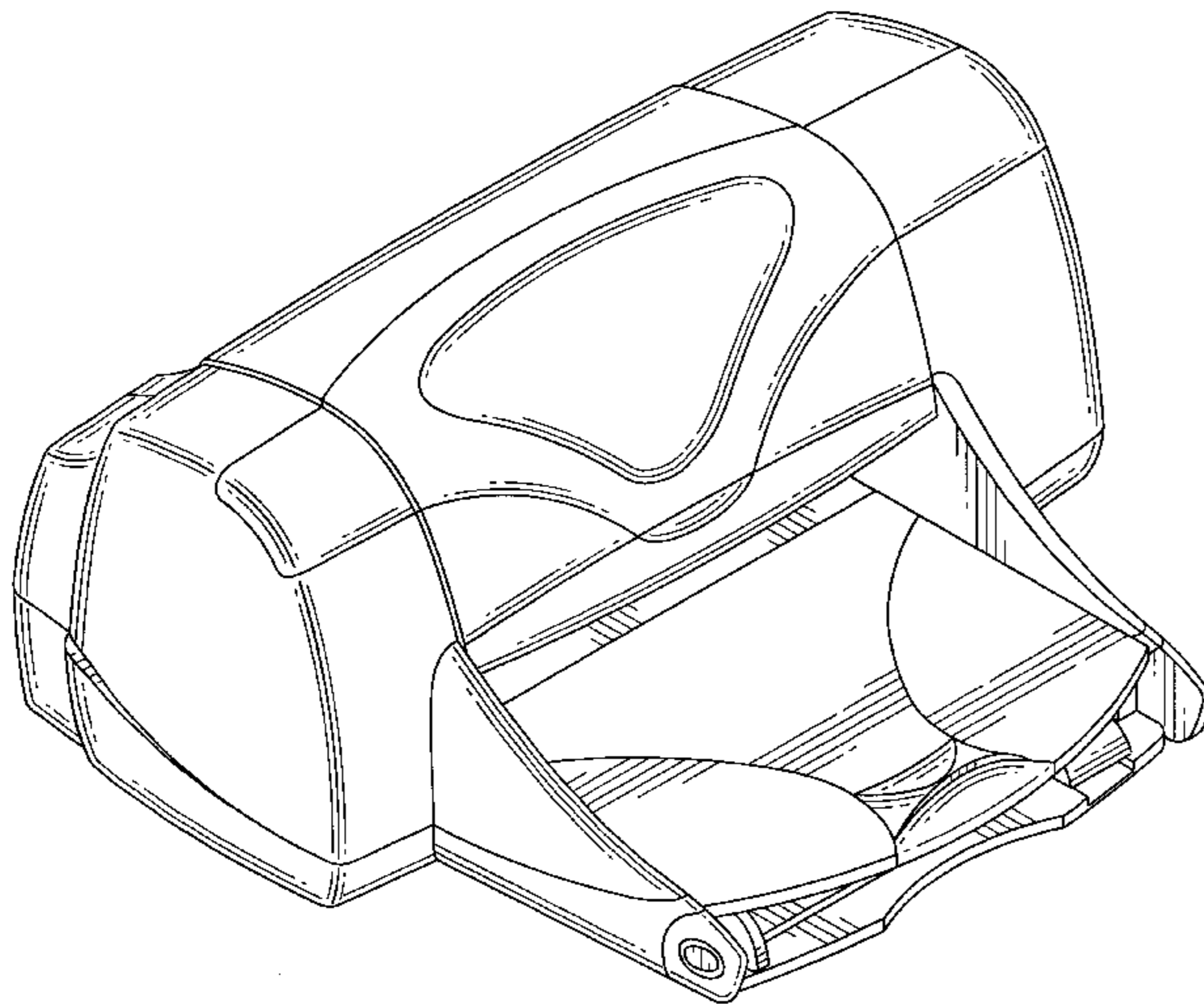
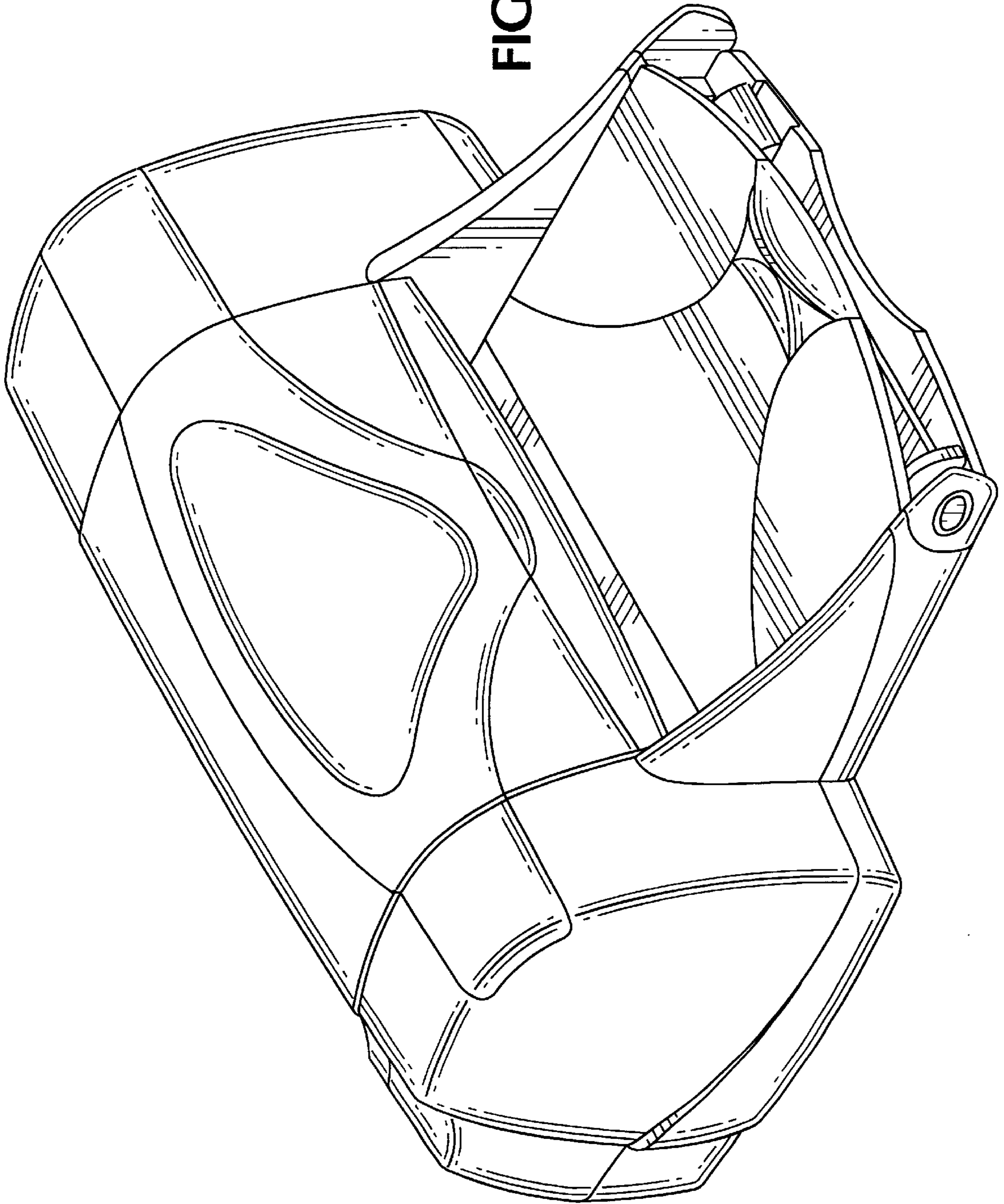

FIG.1



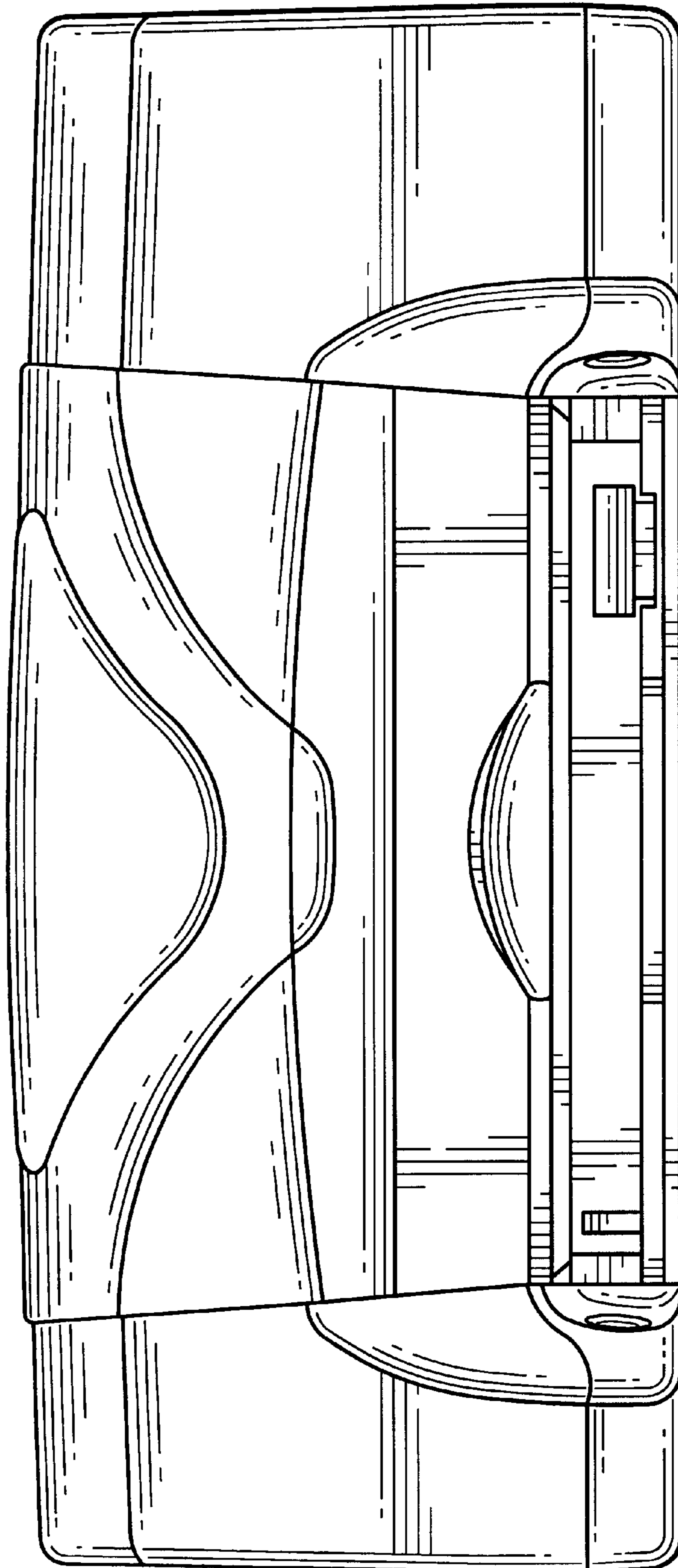

FIG.2

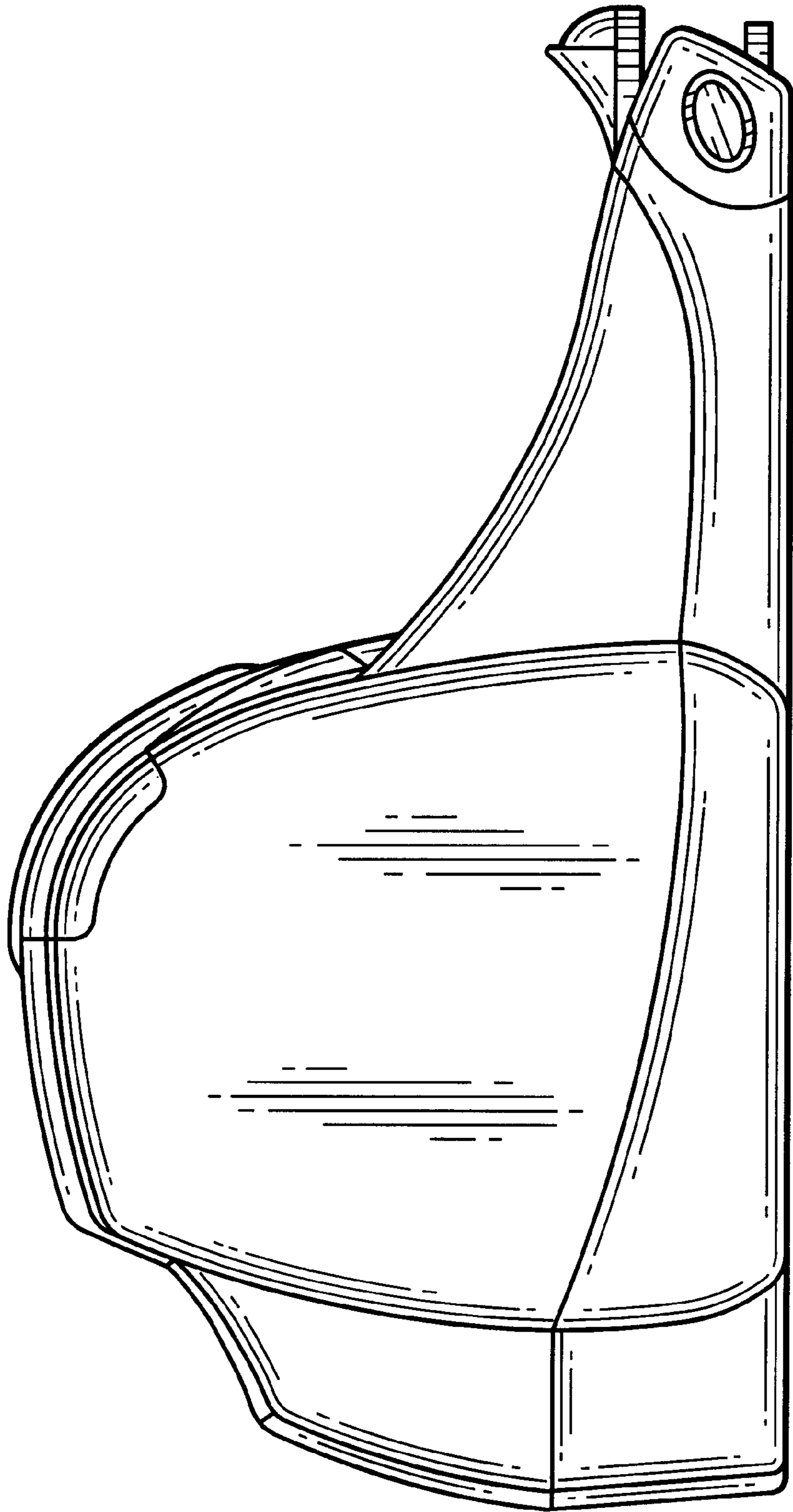

FIG.3

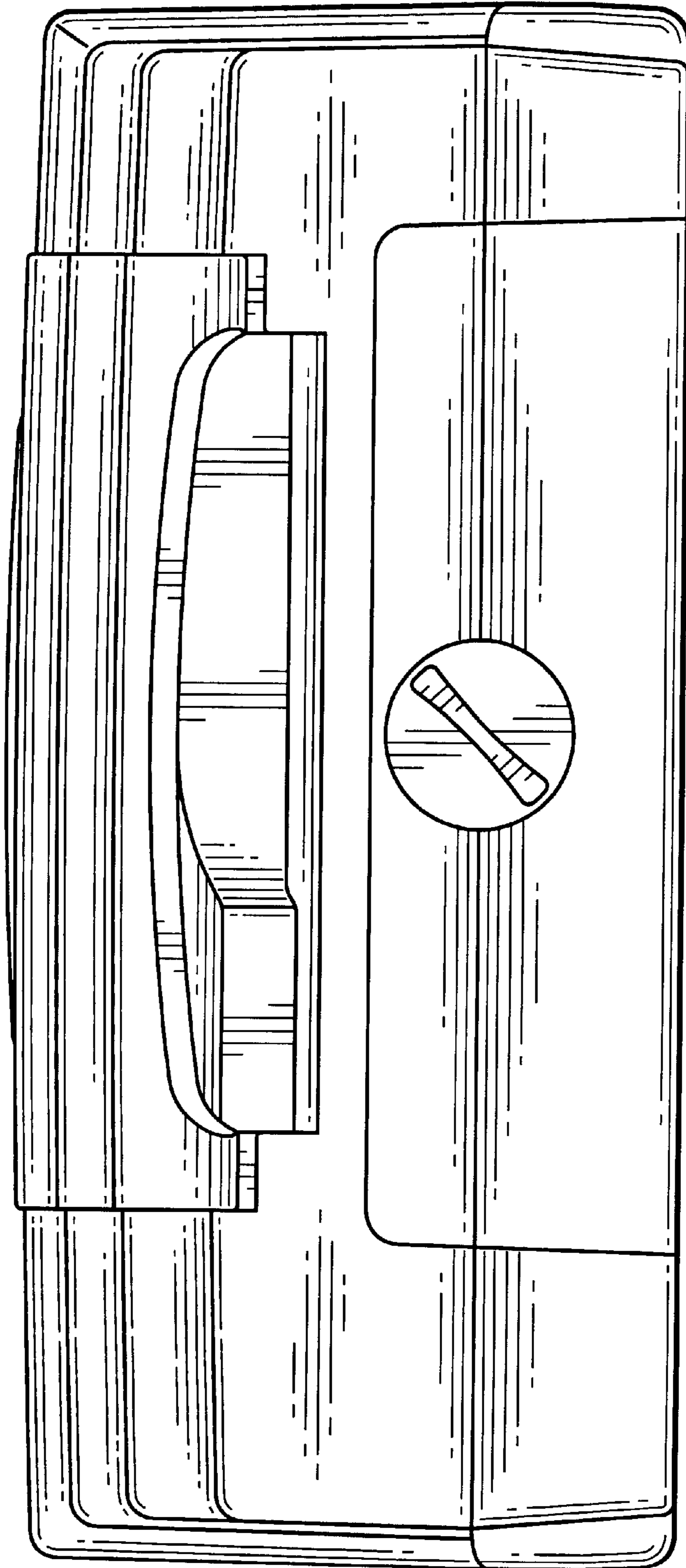

FIG.4

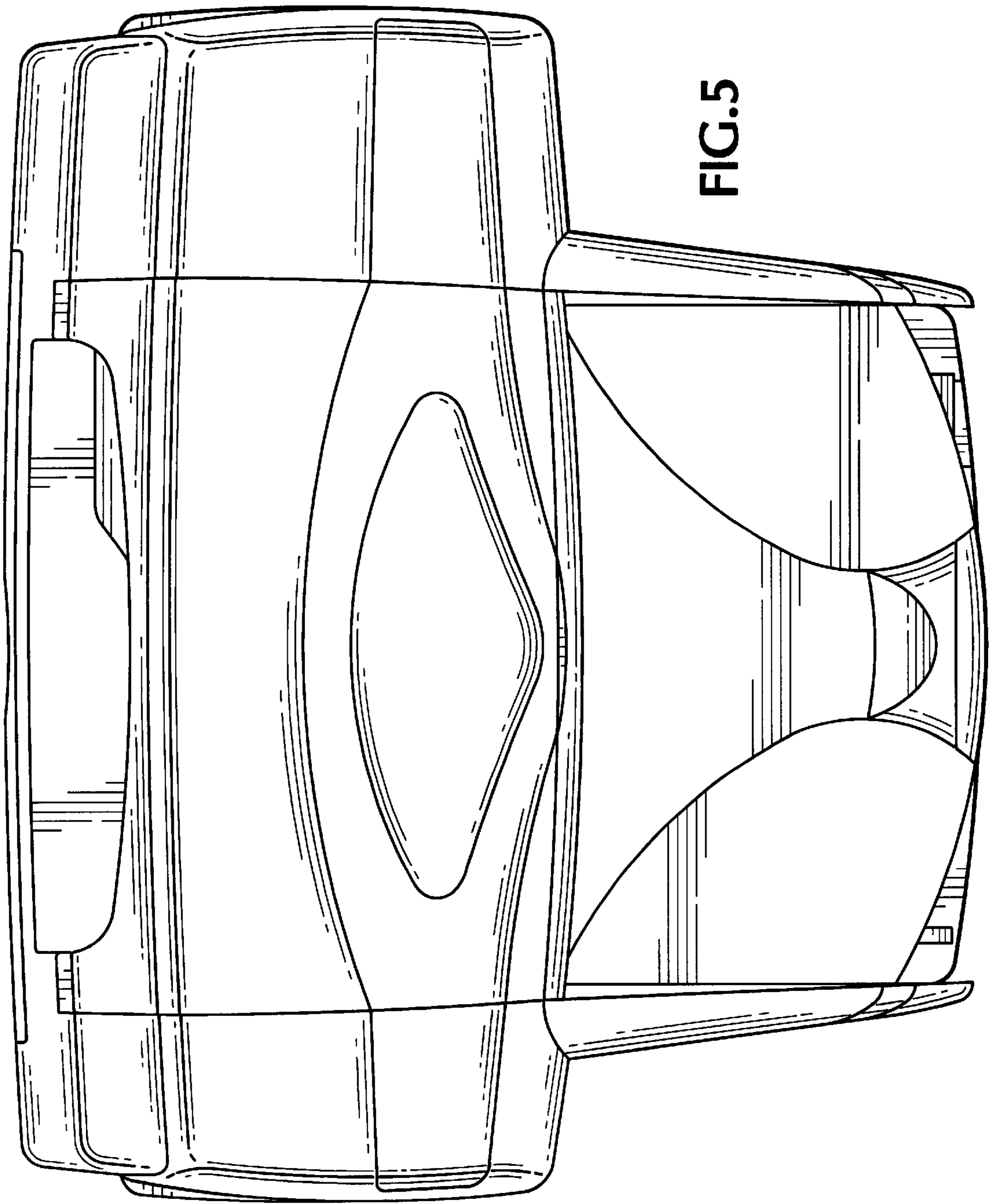
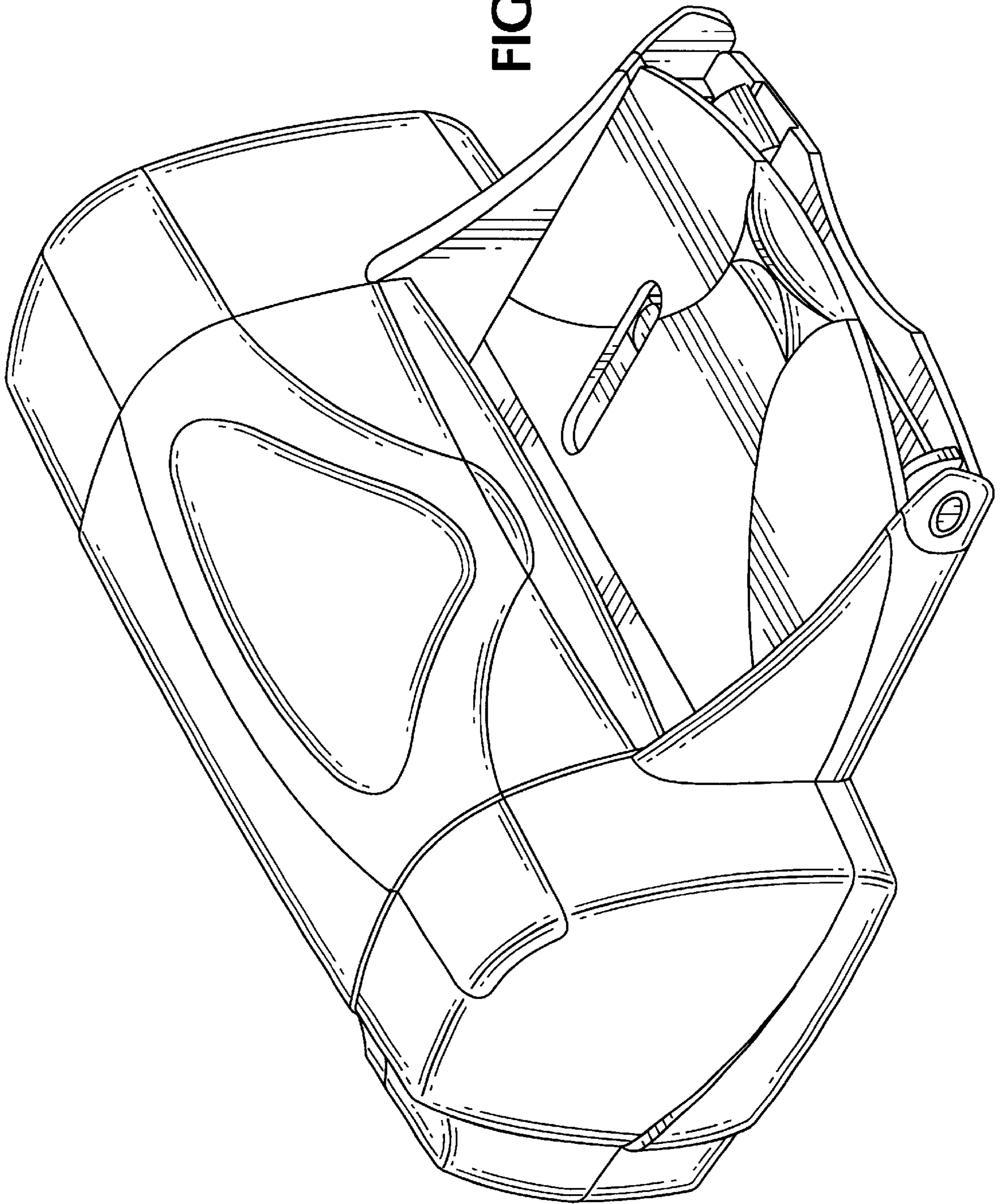

FIG.5

FIG.6



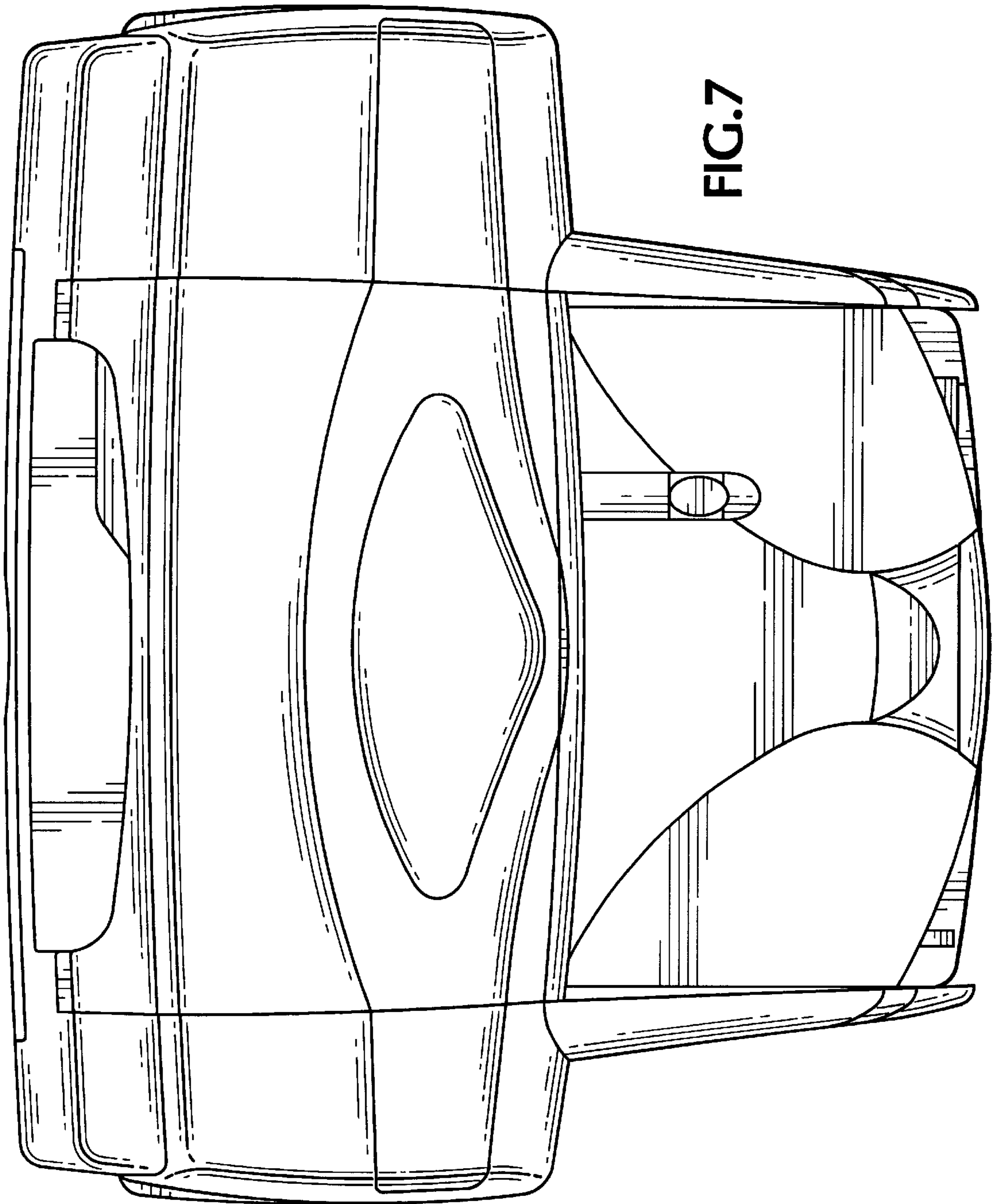

FIG.7