



US00D449329B1

(12) **United States Design Patent**
Suzuki et al.

(10) **Patent No.:** **US D449,329 S**

(45) **Date of Patent:** **** Oct. 16, 2001**

(54) **LENS BARRIER FOR A CAMERA**

(75) Inventors: **Tatsuya Suzuki; Hiroshi Iue**, both of Tokyo (JP)

(73) Assignee: **Olympus Optical Co., Ltd.**, Tokyo (JP)

(**) Term: **14 Years**

(21) Appl. No.: **29/134,149**

(22) Filed: **Dec. 14, 2000**

(30) **Foreign Application Priority Data**

Sep. 6, 2000 (JP) 12-024876

(51) **LOC (7) Cl.** **16-05**

(52) **U.S. Cl.** **D16/219**

(58) **Field of Search** D16/134, 136,
D16/200-205, 217-219; 359/511; 396/59,
349, 448, 534, 535-541

(56) **References Cited**

U.S. PATENT DOCUMENTS

- D. 436,978 * 1/2001 Suzuki et al. D16/219
- D. 444,162 * 6/2001 Senda D16/202
- 5,162,832 * 11/1992 Kakita et al. 396/59
- 5,701,533 * 12/1997 Suzuki et al. 396/349
- 5,708,891 * 1/1998 Ando et al. 396/448

OTHER PUBLICATIONS

The Point Network, Sony catalog, Dec. 15, 1999 cover page (Olympus zoom 74 VF camera).*

* cited by examiner

Primary Examiner—Adir Aronovich

(74) *Attorney, Agent, or Firm*—Hogan & Hartson LLP

(57) **CLAIM**

The ornamental design for a lens barrier for a camera, as shown and described.

DESCRIPTION

FIG. 1 is a top plan view of a lens barrier for a camera, showing our new design;
 FIG. 2 is a front elevational view thereof;
 FIG. 3 is a bottom plan view thereof;
 FIG. 4 is a rear elevational view thereof;
 FIG. 5 is a right side elevational view thereof;
 FIG. 6 is a left side elevational view thereof;
 FIG. 7 is a front elevational view thereof; with a barrier being opened; and,
 FIG. 8 is a horizontal cross-sectional view thereof, taken along a line crossing a central portion of the camera.
 The broken line portions of a camera are shown to illustrate environment only and form no part of the claimed design.

1 Claim, 2 Drawing Sheets

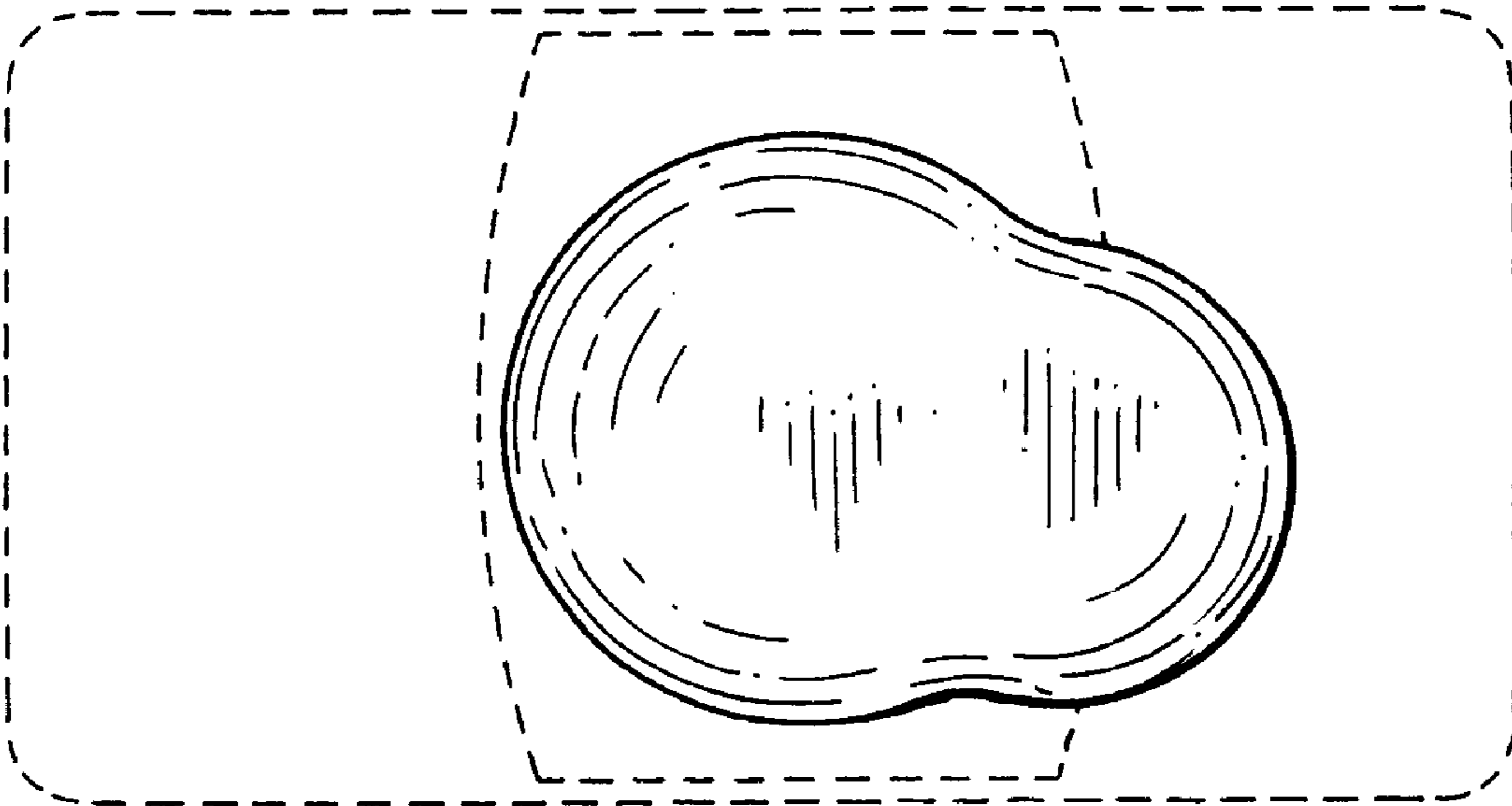

FIG. 1

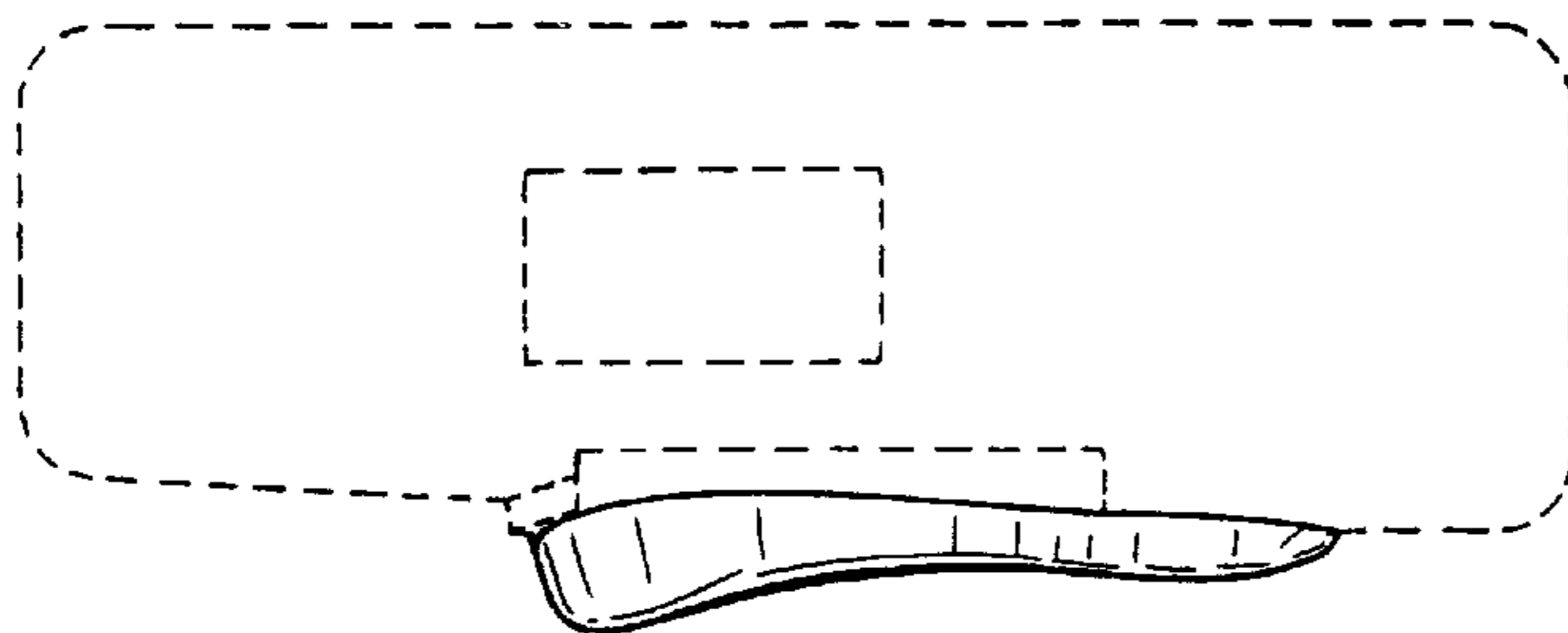

FIG. 2

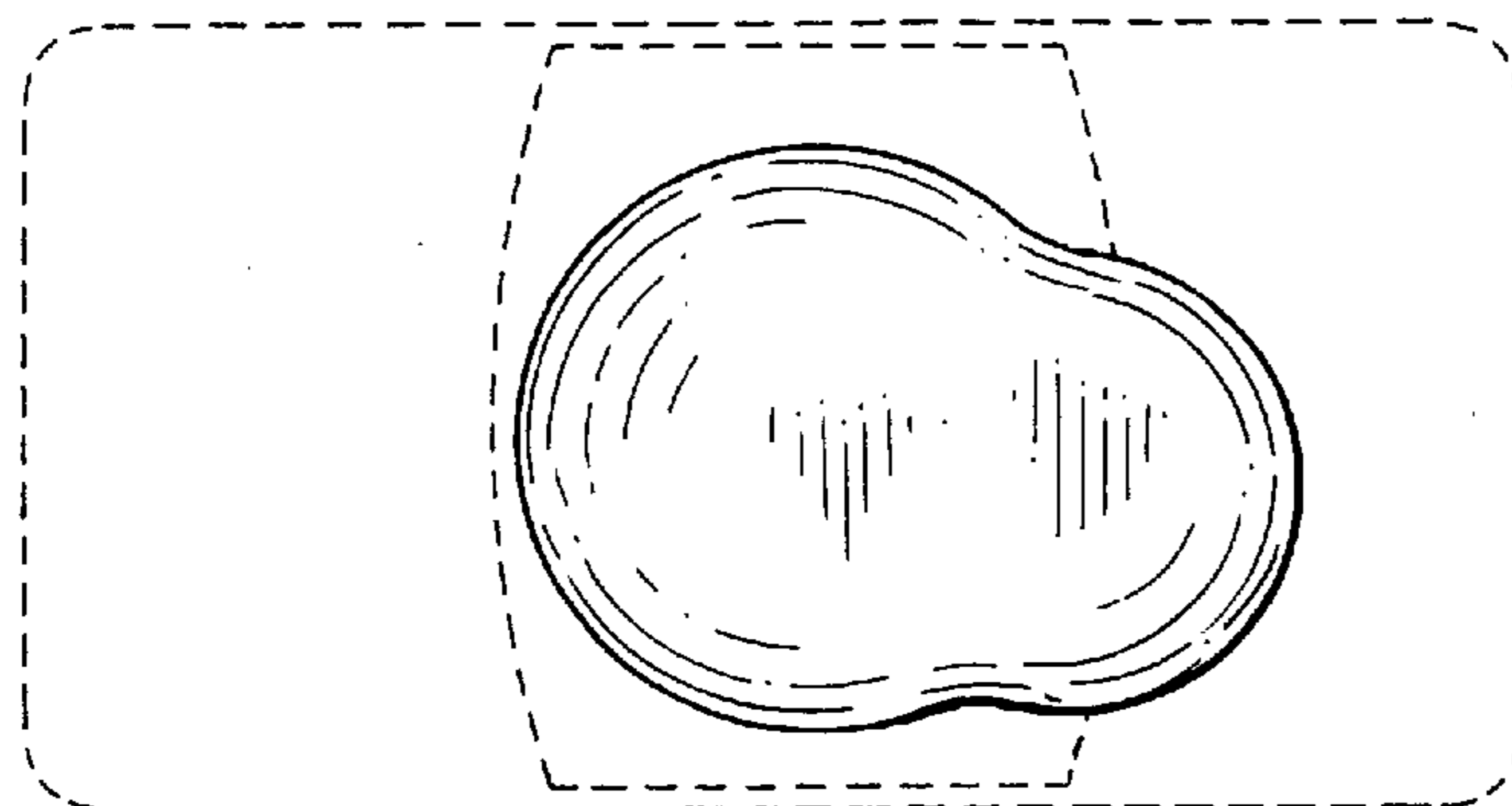

FIG. 5

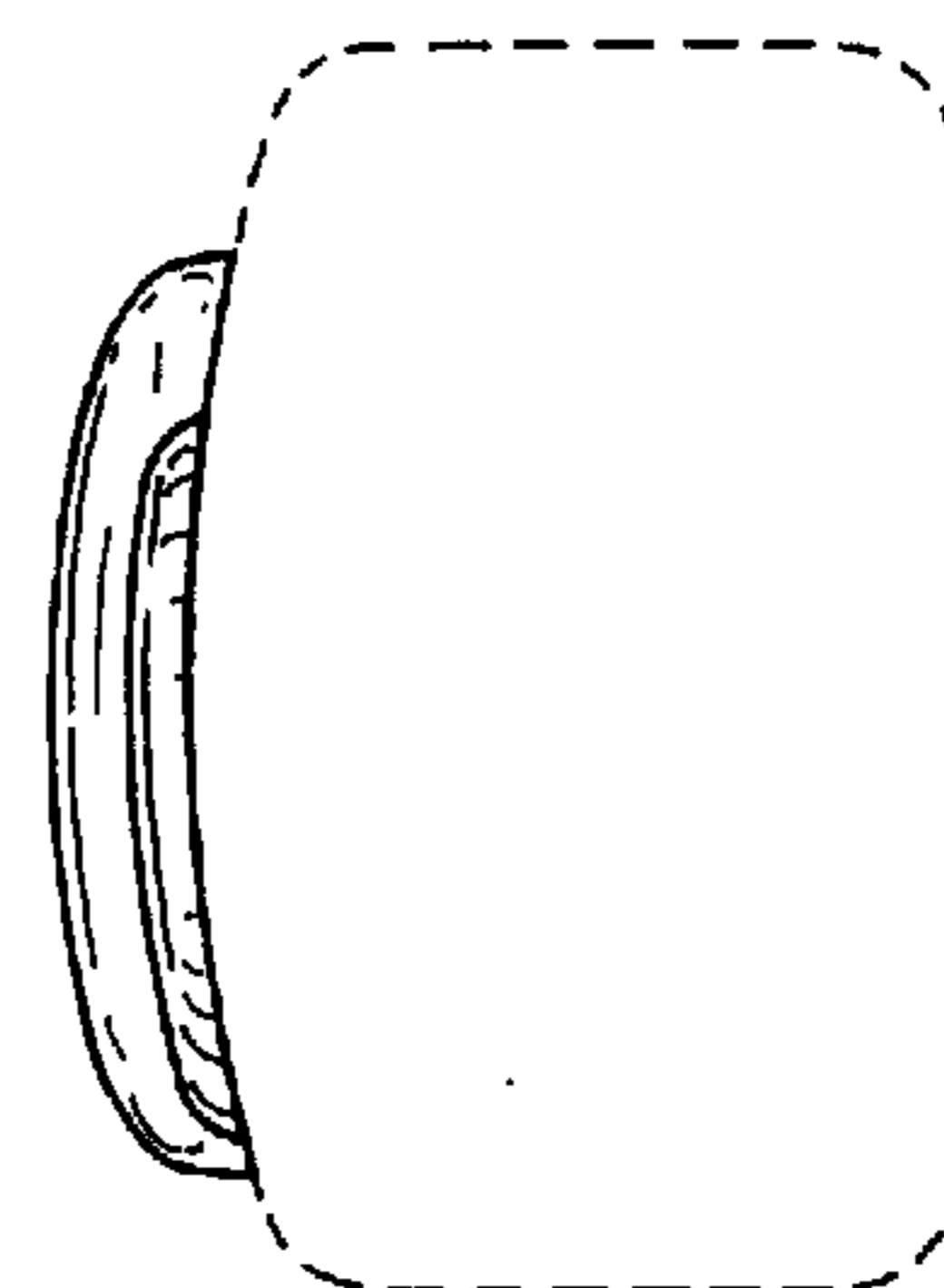

FIG. 3

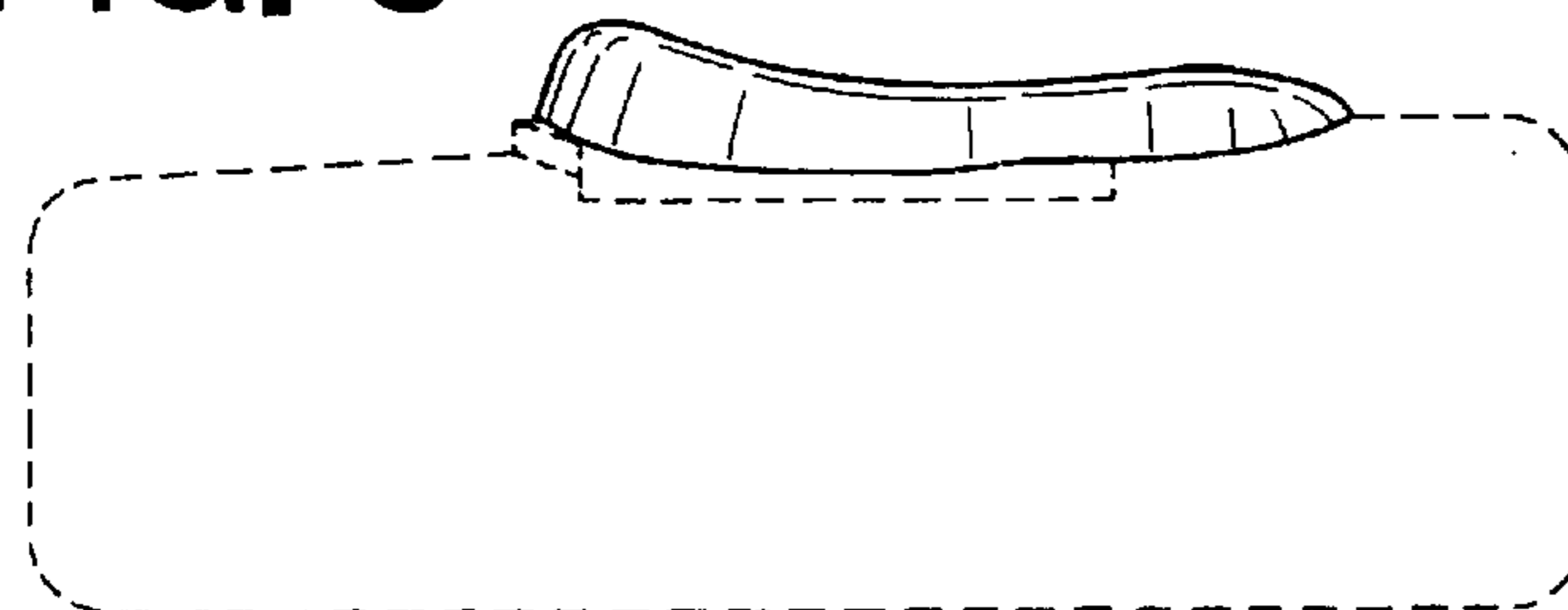

FIG. 6

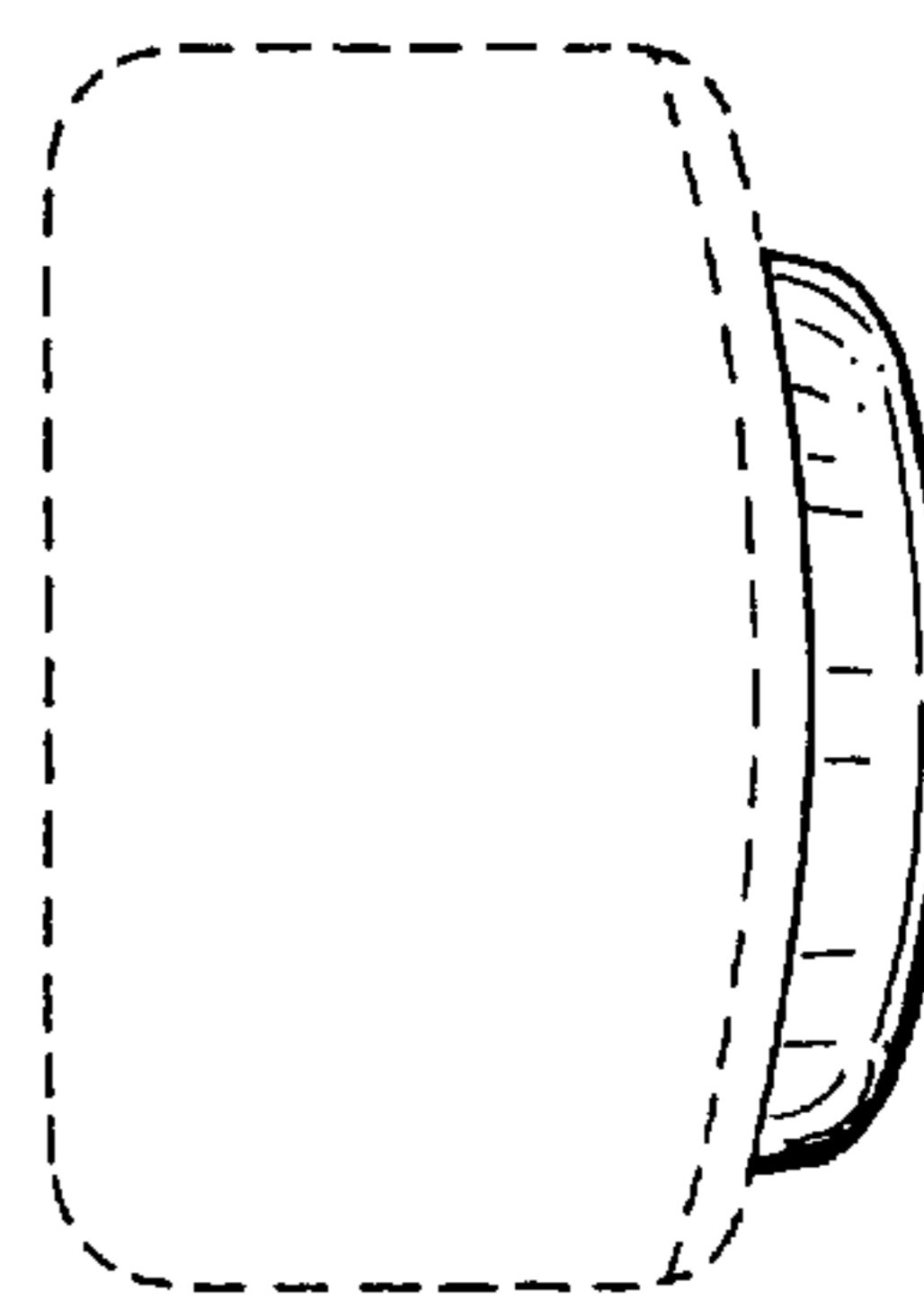

FIG. 4

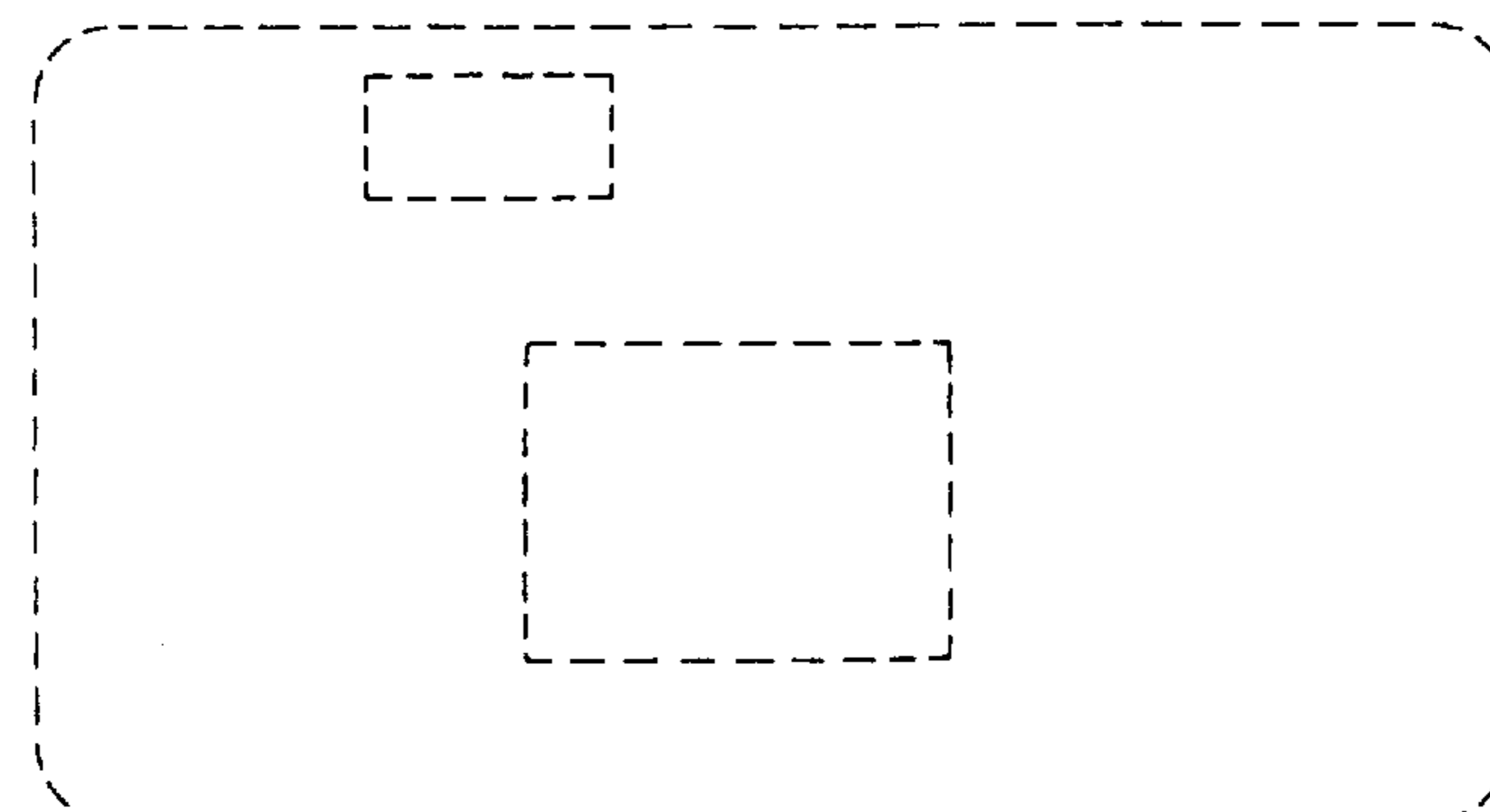

FIG. 7

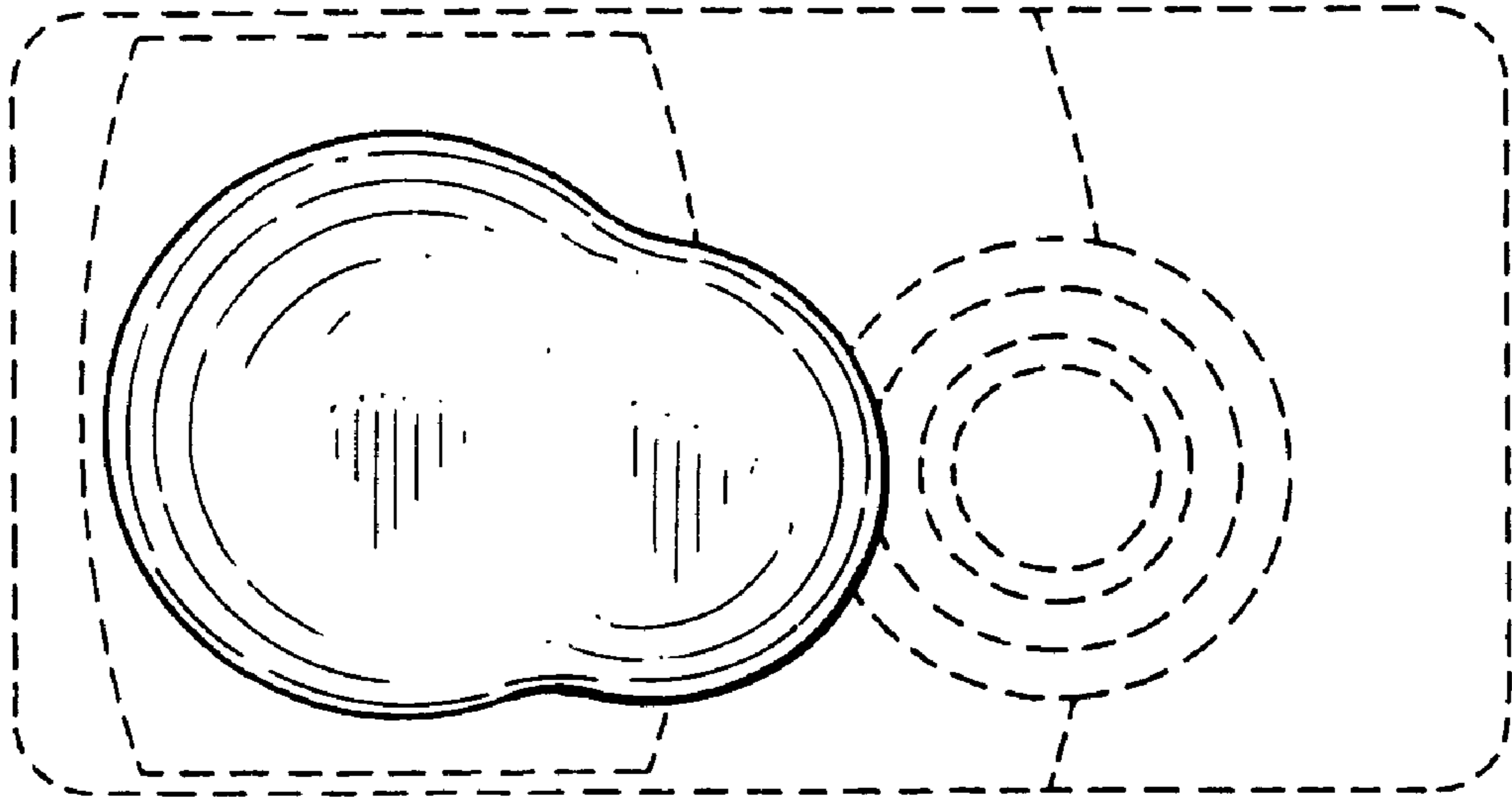

FIG. 8

