



US00D449304B1

(12) **United States Design Patent**
Herath

(10) **Patent No.:** **US D449,304 S**

(45) **Date of Patent:** **** Oct. 16, 2001**

(54) **PALM V ADAPTER**

(75) **Inventor:** **Jeffrey Alan Herath**, Virginia Beach, VA (US)

(73) **Assignee:** **Vianix, LC**, Virginia Beach, VA (US)

(**) **Term:** **14 Years**

(21) **Appl. No.:** **29/133,096**

(22) **Filed:** **Nov. 22, 2000**

(51) **LOC (7) Cl.** **14-02**

(52) **U.S. Cl.** **D14/433**

(58) **Field of Search** D14/432, 433, D14/439; D13/147, 146, 133, 184; 361/683; 439/620, 633, 651, 347, 357

(56) **References Cited**

U.S. PATENT DOCUMENTS

- D. 308,197 * 5/1990 Inoue D14/433
- D. 317,913 * 7/1991 Inoue D14/433

- D. 348,874 * 7/1994 Pemberton D14/433
- D. 372,708 * 8/1996 Hetherington D14/433

* cited by examiner

Primary Examiner—Kay H. Chin

(74) *Attorney, Agent, or Firm*—Kaufman & Canoles

(57) **CLAIM**

The ornamental design for a palm V adapter, as shown and described.

DESCRIPTION

FIG. 1 is a perspective view of a palm V adapter;
 FIG. 2 is a left side view thereof;
 FIG. 3 is a top plan view thereof;
 FIG. 4 is a front elevational view thereof;
 FIG. 5 is a right side view thereof;
 FIG. 6 is a bottom plan view thereof; and,
 FIG. 7 is a rear elevational view thereof.

1 Claim, 3 Drawing Sheets

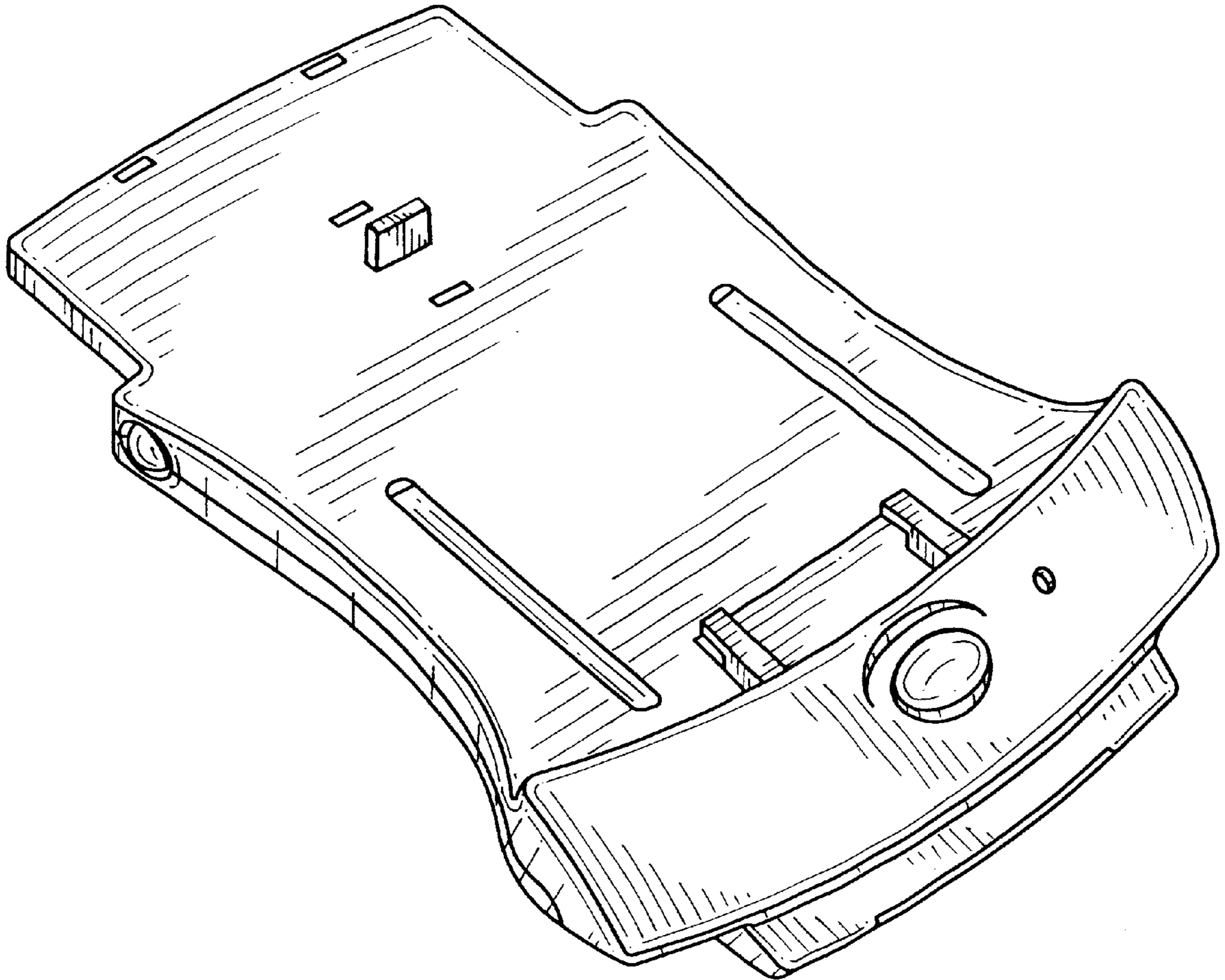

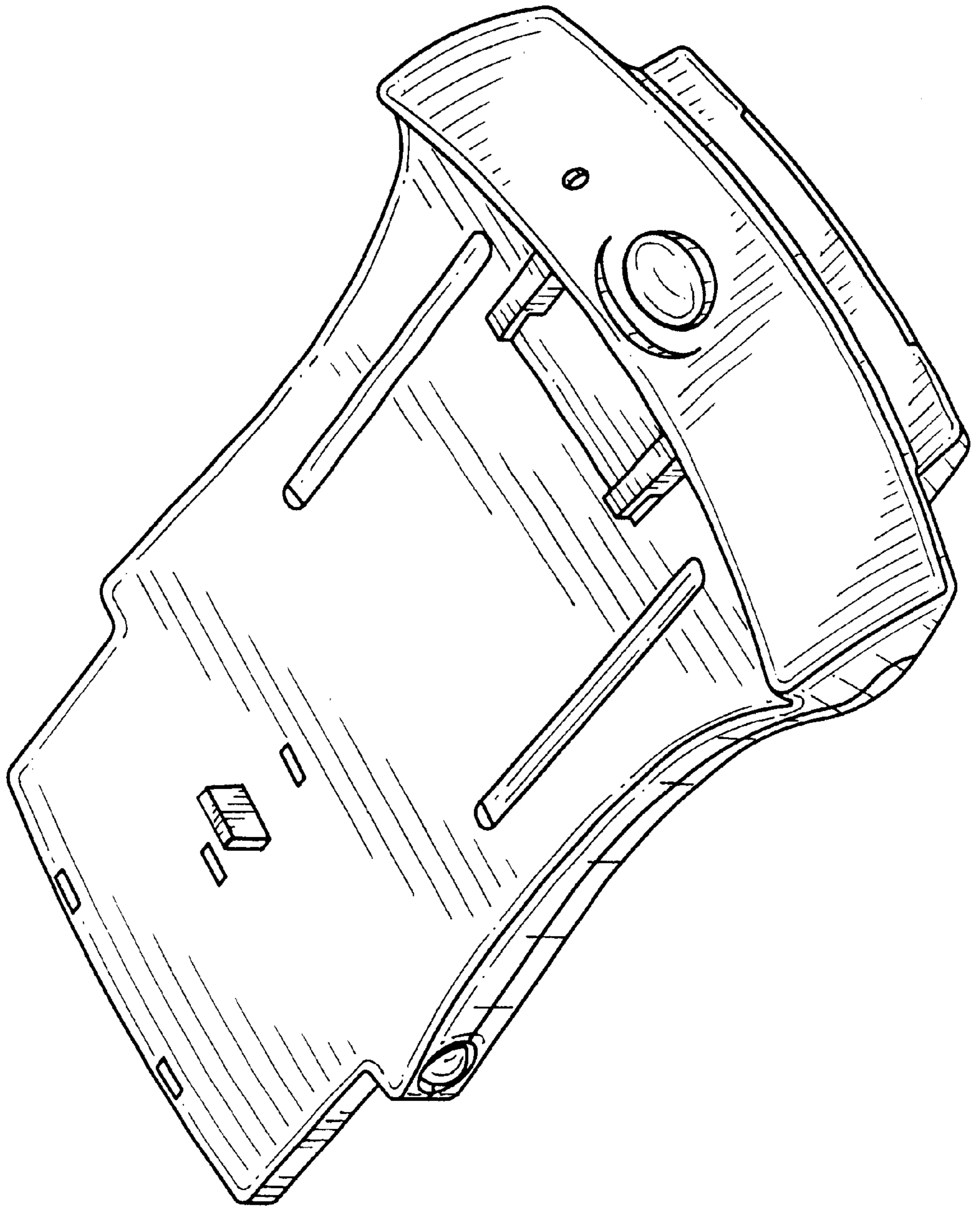

FIG. 1

FIG. 2

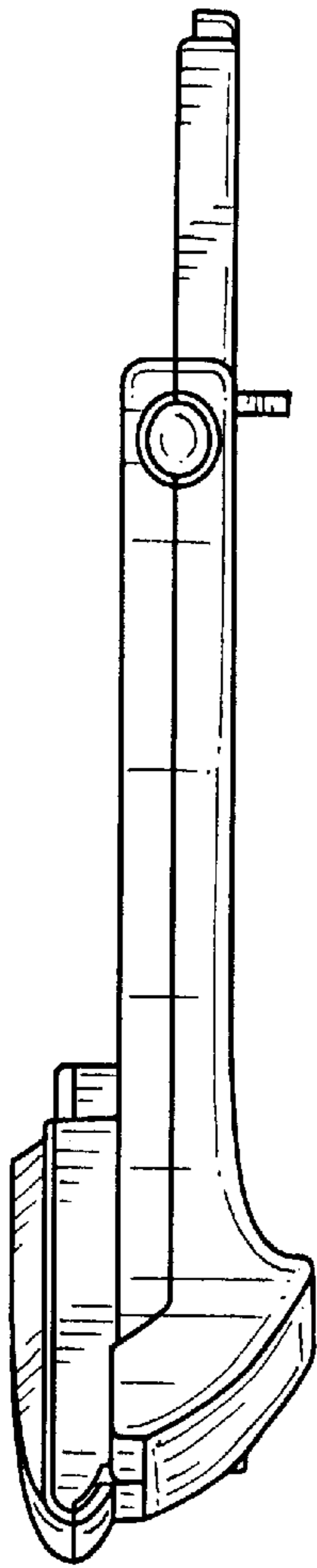

FIG. 3

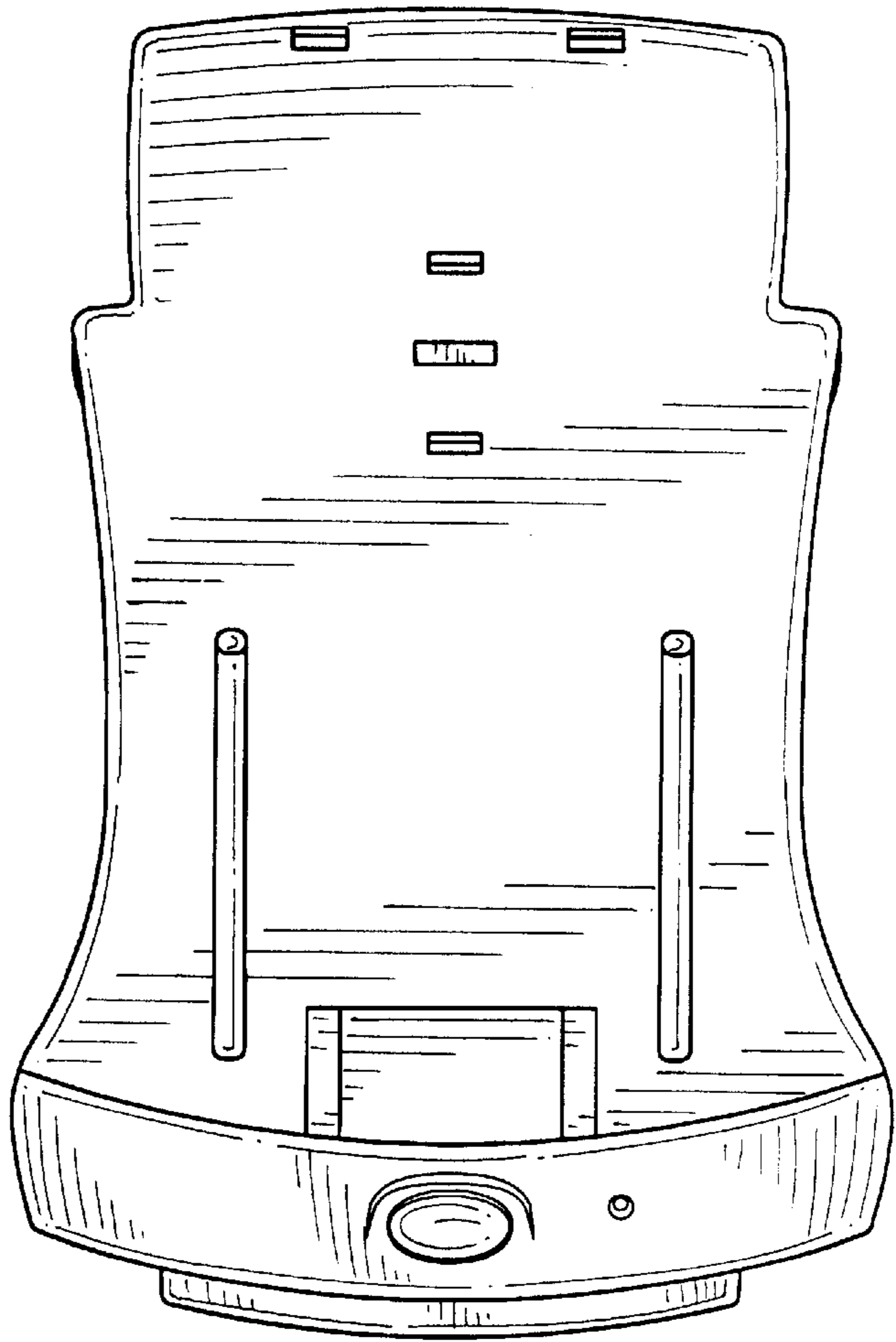

FIG. 4

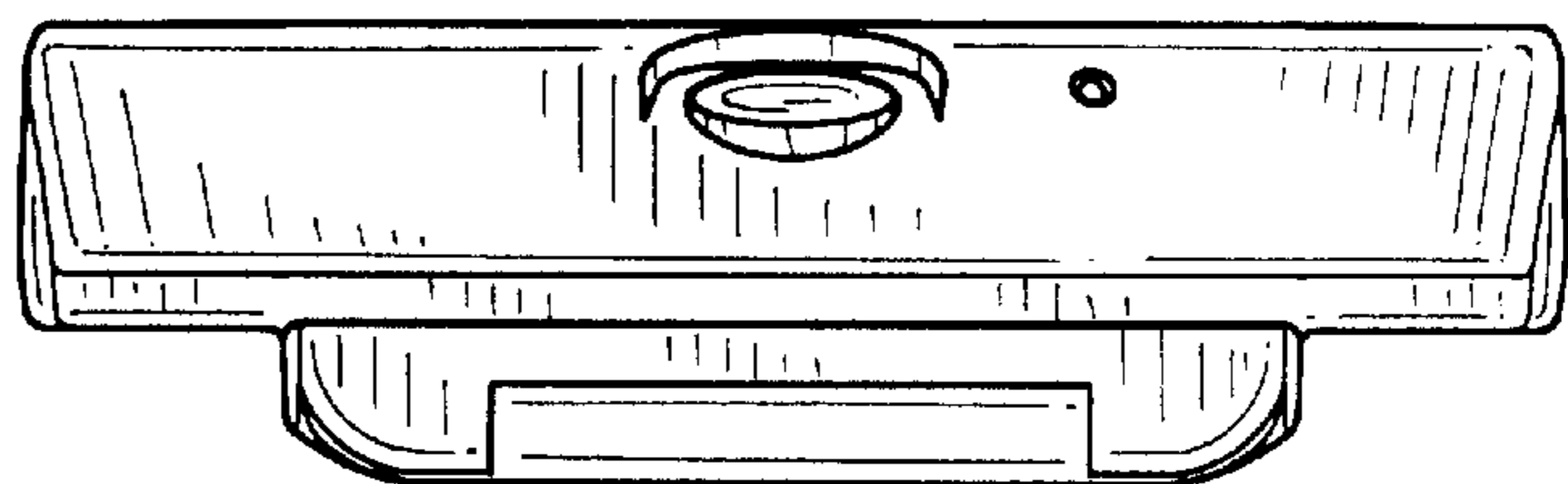

FIG. 5

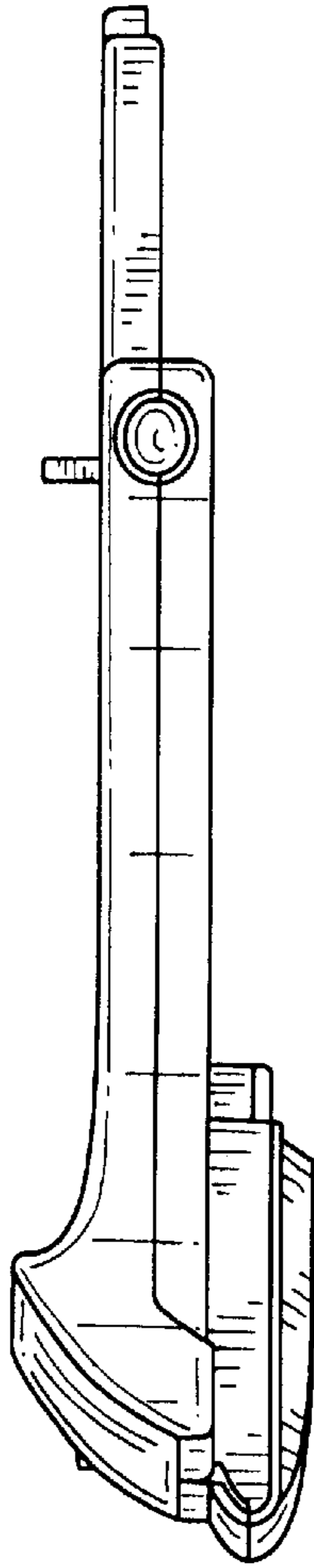

FIG. 6

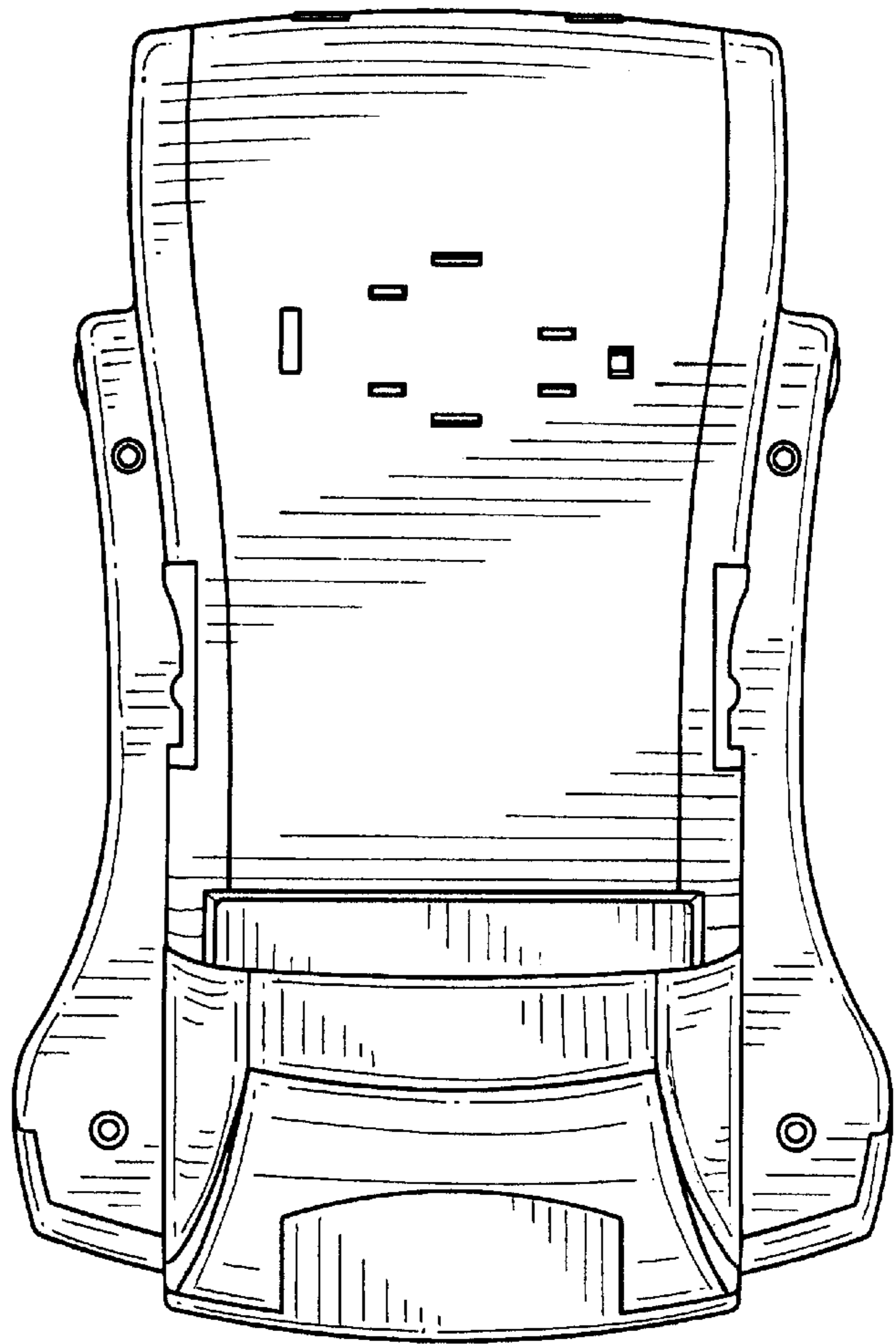

FIG. 7

