



US00D449226B1

(12) **United States Design Patent**
Hedstrom et al.

(10) **Patent No.:** **US D449,226 S**
(45) **Date of Patent:** **** Oct. 16, 2001**

(54) **CONTAINER FOR MEDICINAL DOSAGE FORMS**

(75) Inventors: **Henrik Hedstrom**, Berwyn, PA (US);
Paul Jansson, Kungälv (SE); **Mark Talbot Ames**, Westport, CT (US); **John C. Oglio**, New City, NY (US)

(73) Assignee: **AstraZeneca AB**, Sodertälje (SE)

(**) Term: **14 Years**

(21) Appl. No.: **29/135,723**

(22) Filed: **Jan. 17, 2001**

(51) **LOC (7) Cl.** **09-03**

(52) **U.S. Cl.** **D9/415**

(58) **Field of Search** D9/415, 414, 337,
D9/428, 429, 341; 206/461-471, 806, 495,
528, 530, 539, 828, 822; D24/100-104;
D3/203; 220/4.21-4.25

(56) **References Cited**

U.S. PATENT DOCUMENTS

D. 398,842	*	9/1998	Rohrig	D9/415
D. 436,531	*	1/2001	Holmes et al.	D9/415
3,776,375	*	12/1973	Rohdin	206/470
4,512,474	*	4/1985	Harding	206/470
4,732,273	*	3/1988	DeMarco	206/470
5,540,324	*	7/1996	Knapp	206/470
5,849,378	*	12/1998	Gusk	206/470

* cited by examiner

Primary Examiner—Prabhakar Deshmukh

(74) *Attorney, Agent, or Firm*—White & Case LLP

(57) **CLAIM**

The ornamental design for a container for medicinal dosage forms, as shown and described.

DESCRIPTION

FIG. 1 is a rearward-looking perspective view of a first embodiment of a container for medicinal dosage forms showing our new design from above;

FIG. 2 is a frontward-looking perspective view thereof from below;

FIG. 3 is a top view thereof;

FIG. 4 is a side view thereof;

FIG. 5 is a bottom view thereof;

FIG. 6 is a front view thereof;

FIG. 7 is a side view thereof;

FIG. 8 is a back view thereof;

FIG. 9 is a rearward-looking exploded perspective view thereof from above;

FIG. 10 is a frontward-looking exploded perspective view thereof from below;

FIG. 11 is a rearward-looking perspective view of a second embodiment of the container from above, the only difference with the design of FIG. 1 being the appearance of three parallel stripes on a portion of the container as shown;

FIG. 12 is a frontward-looking perspective view thereof from below;

FIG. 13 is a top view thereof;

FIG. 14 is a side view thereof;

FIG. 15 is a bottom view thereof;

FIG. 16 is a front view thereof;

FIG. 17 is a side view thereof;

FIG. 18 is a back view thereof;

FIG. 19 is a rearward-looking exploded perspective view thereof from above; and,

FIG. 20 is a frontward-looking exploded perspective view thereof.

1 Claim, 10 Drawing Sheets

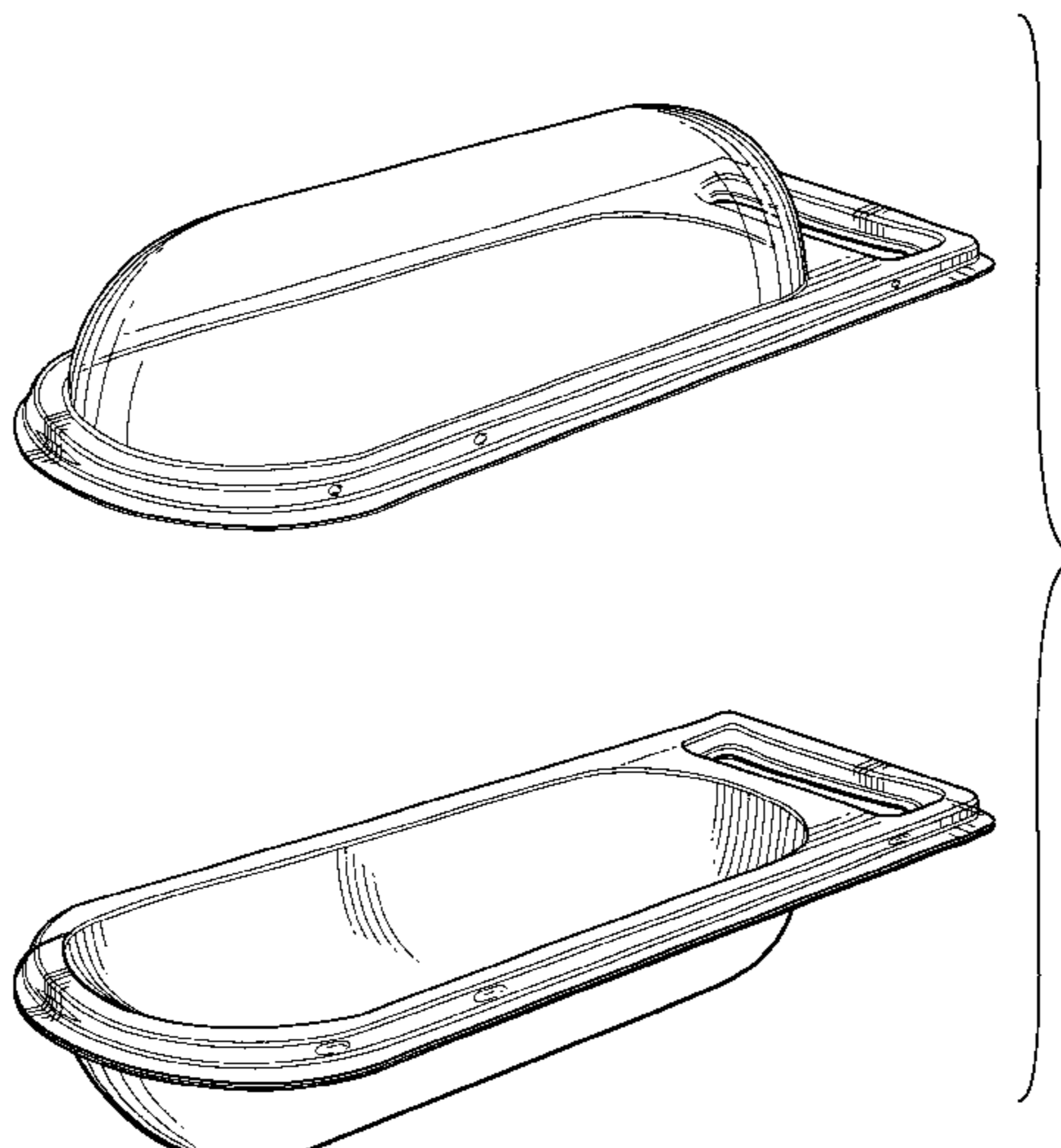

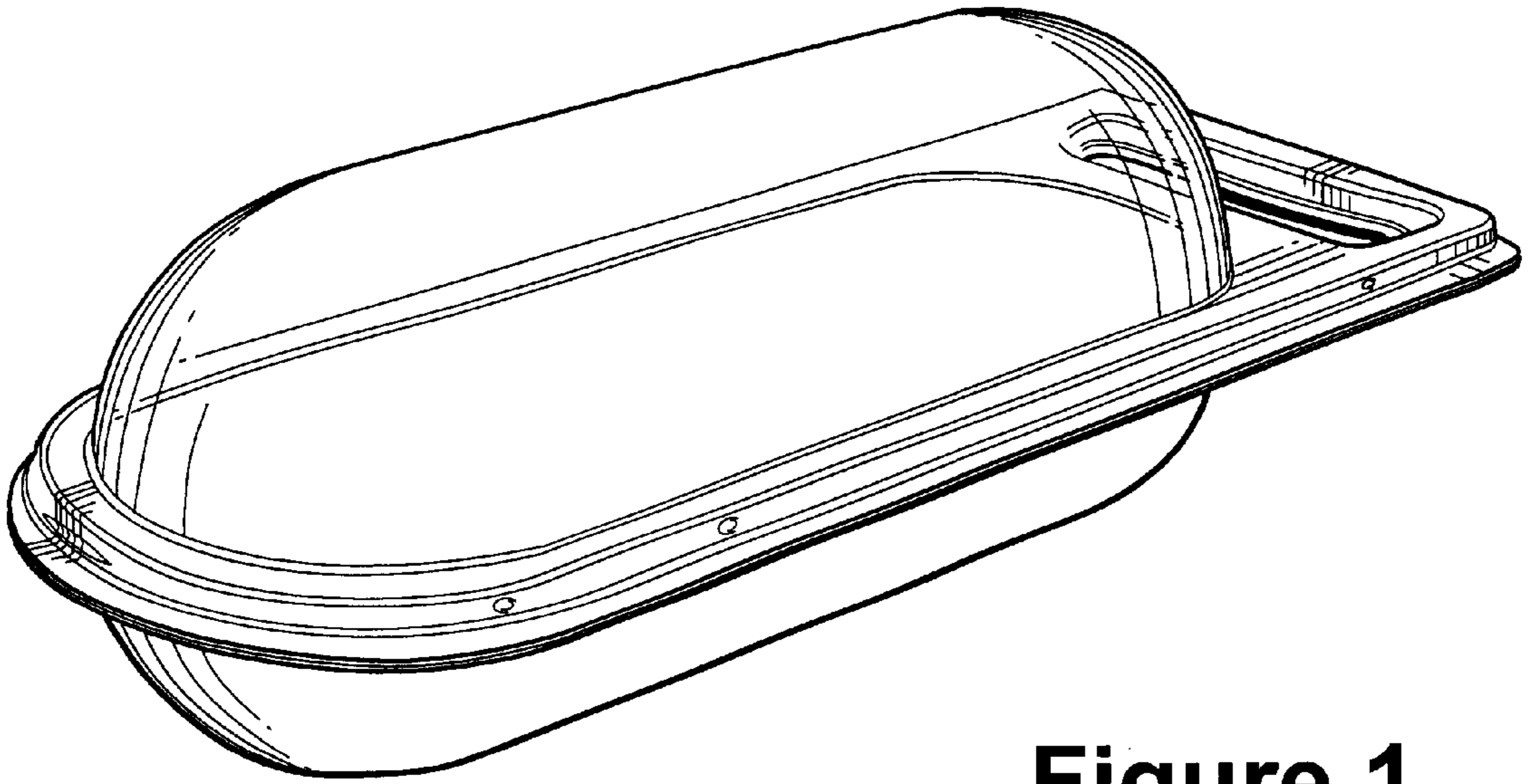

Figure 1

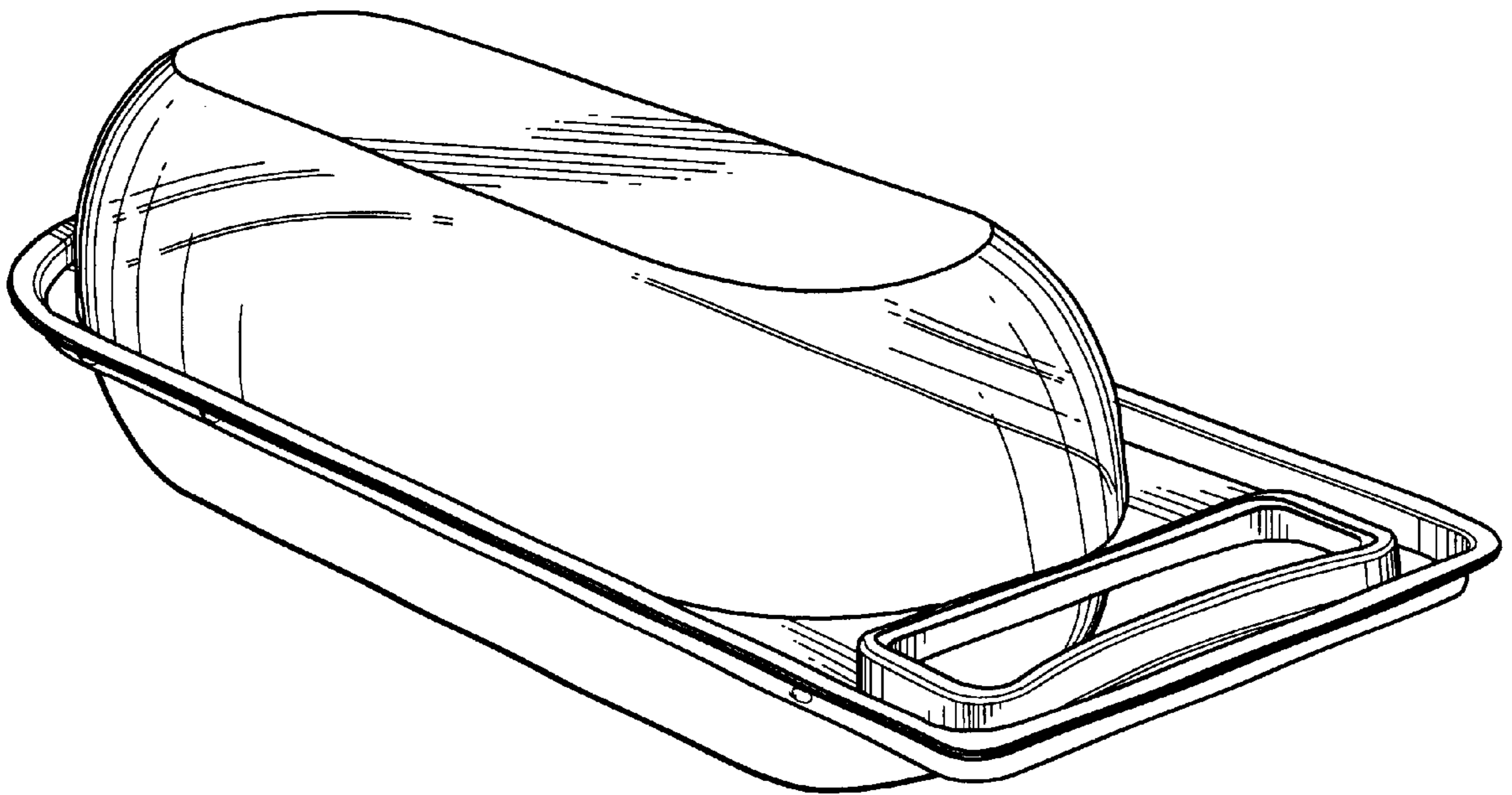

Figure 2

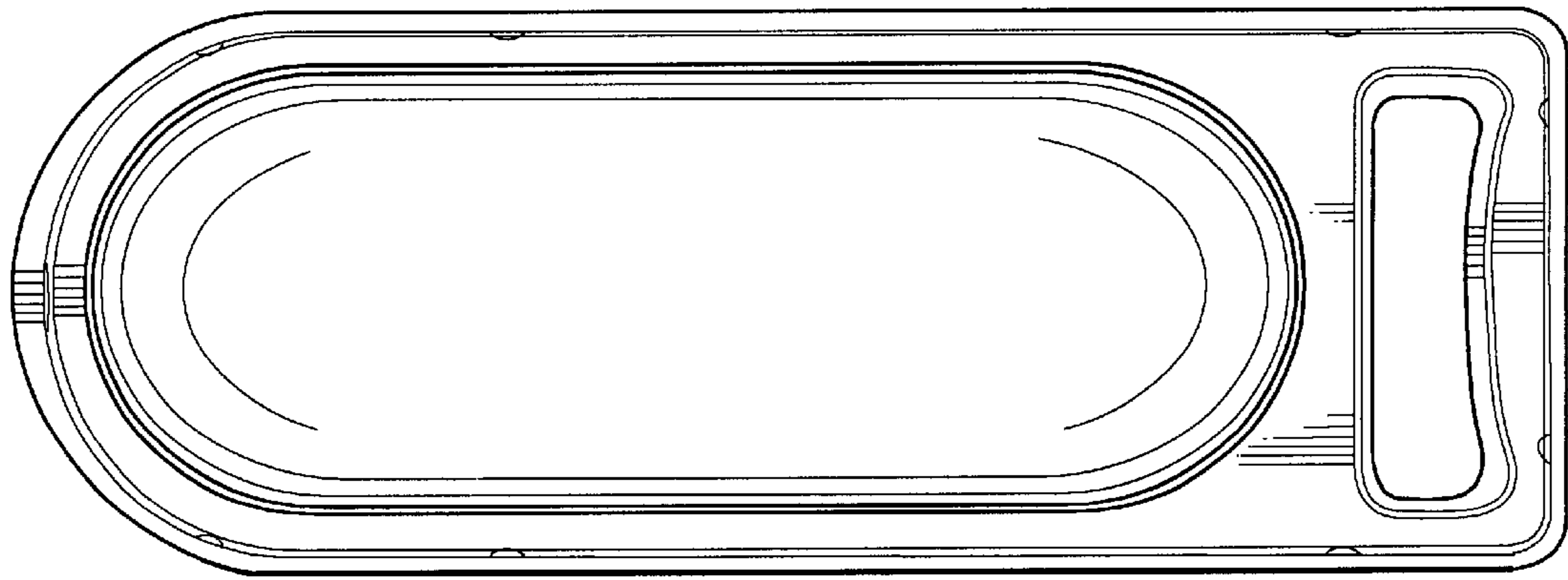

Figure 3

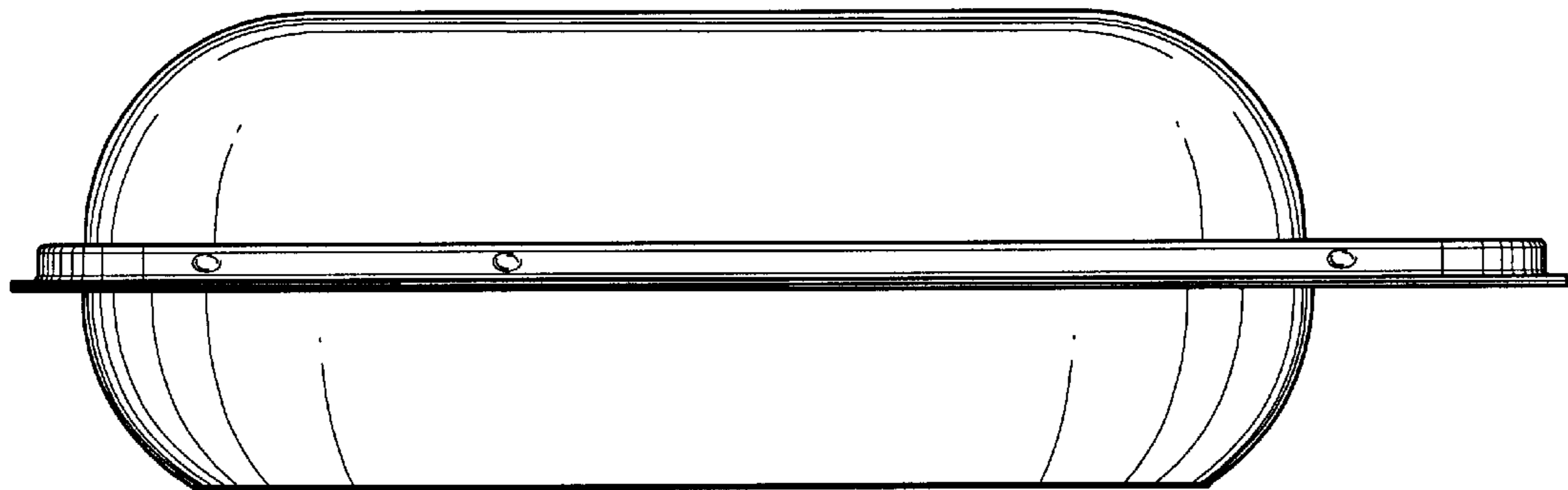

Figure 4

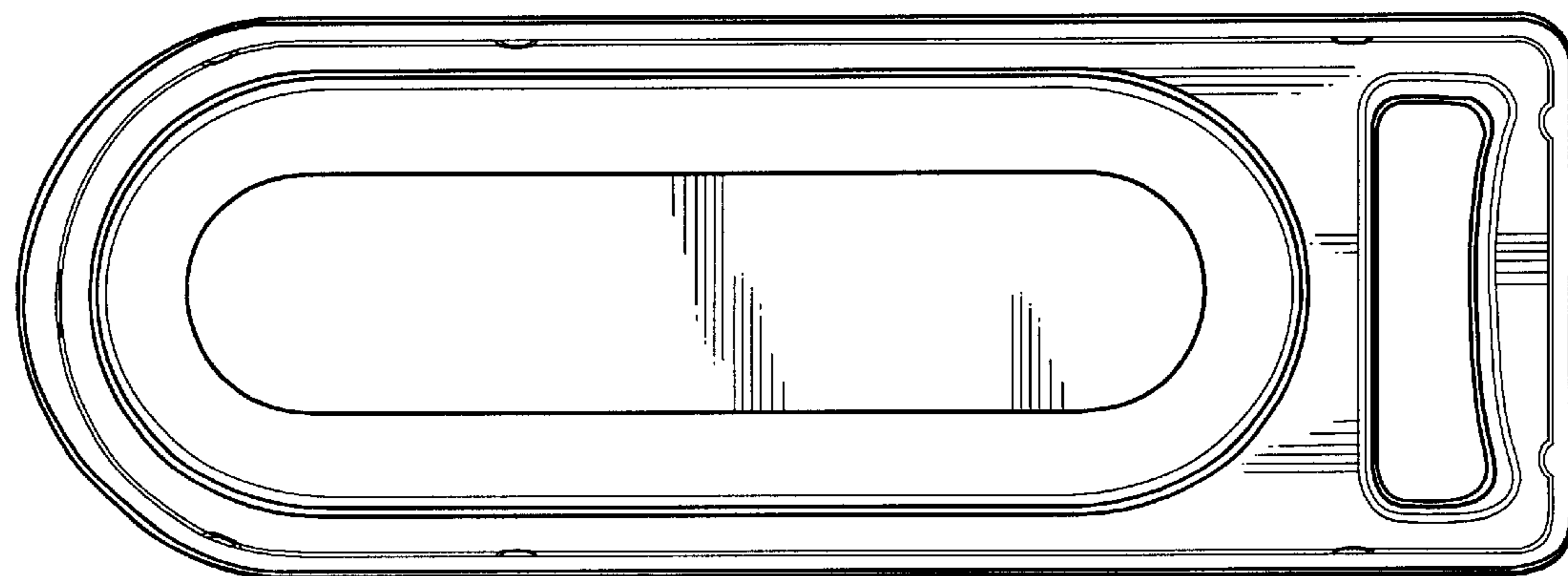

Figure 5

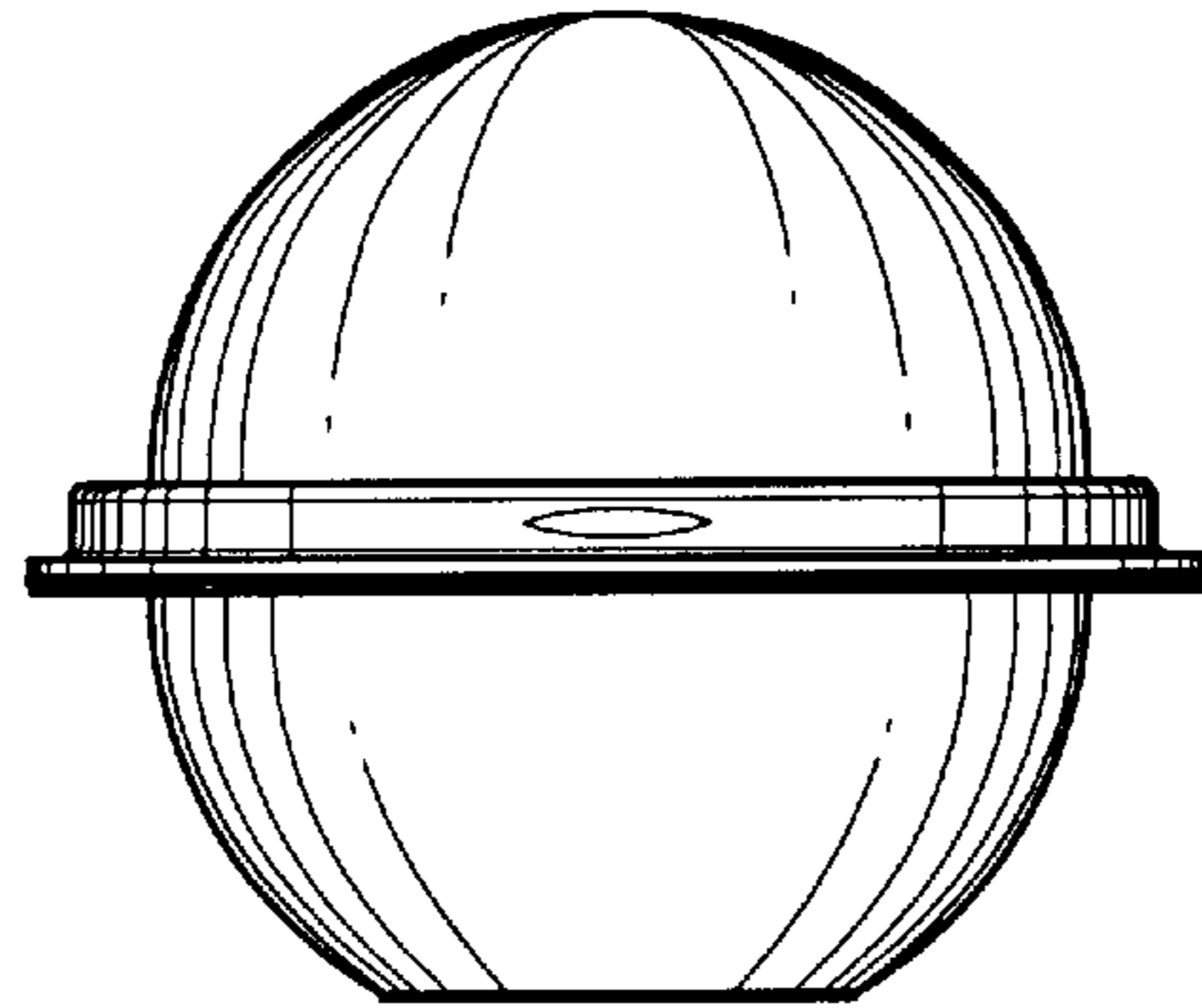

Figure 6

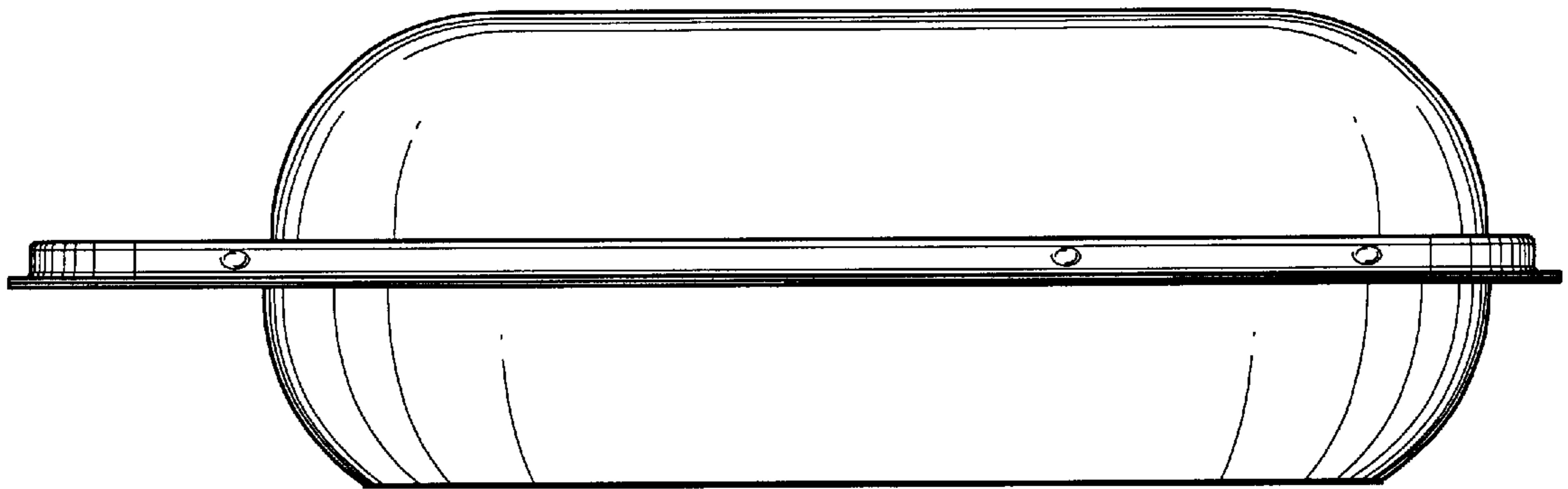

Figure 7

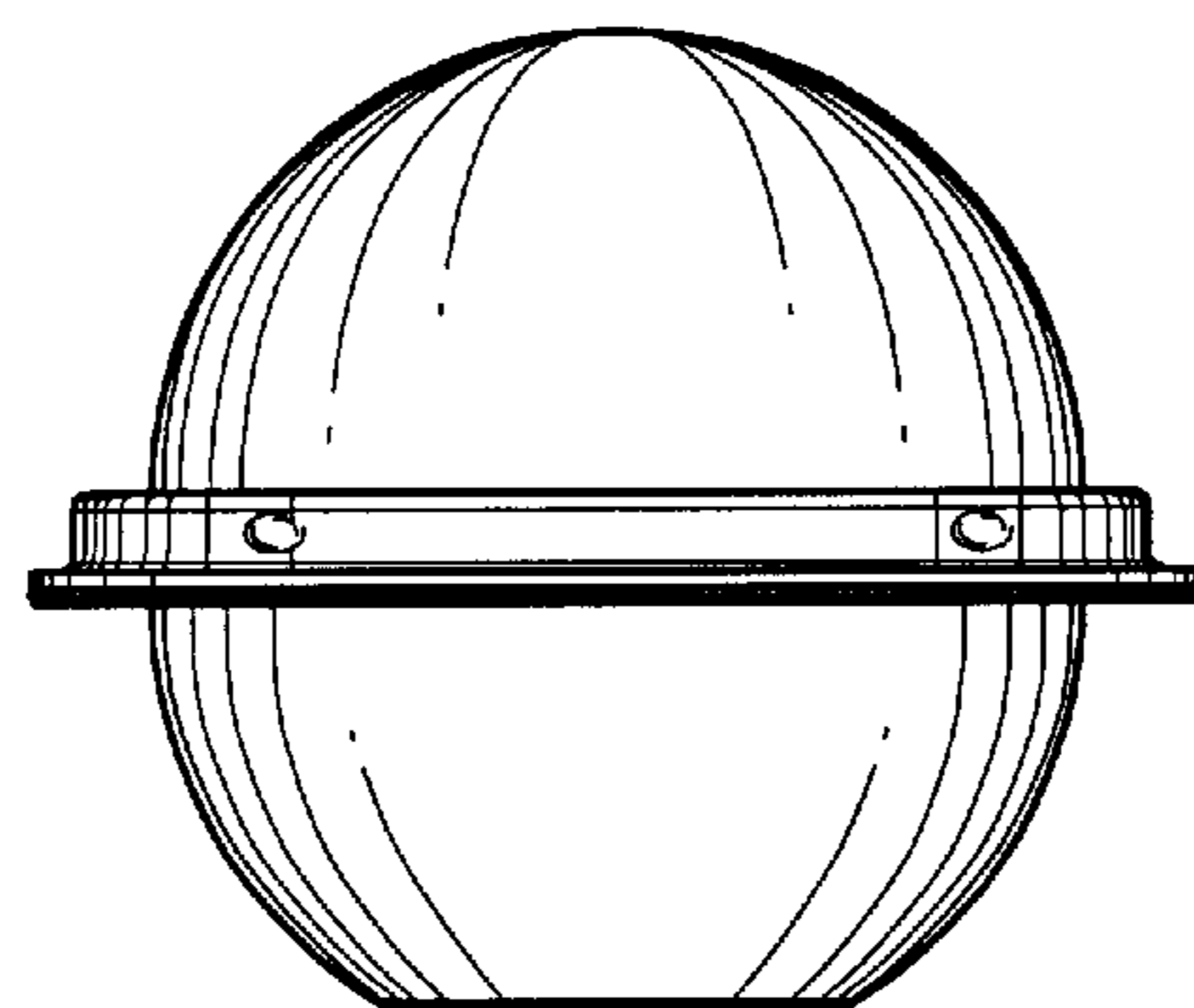

Figure 8

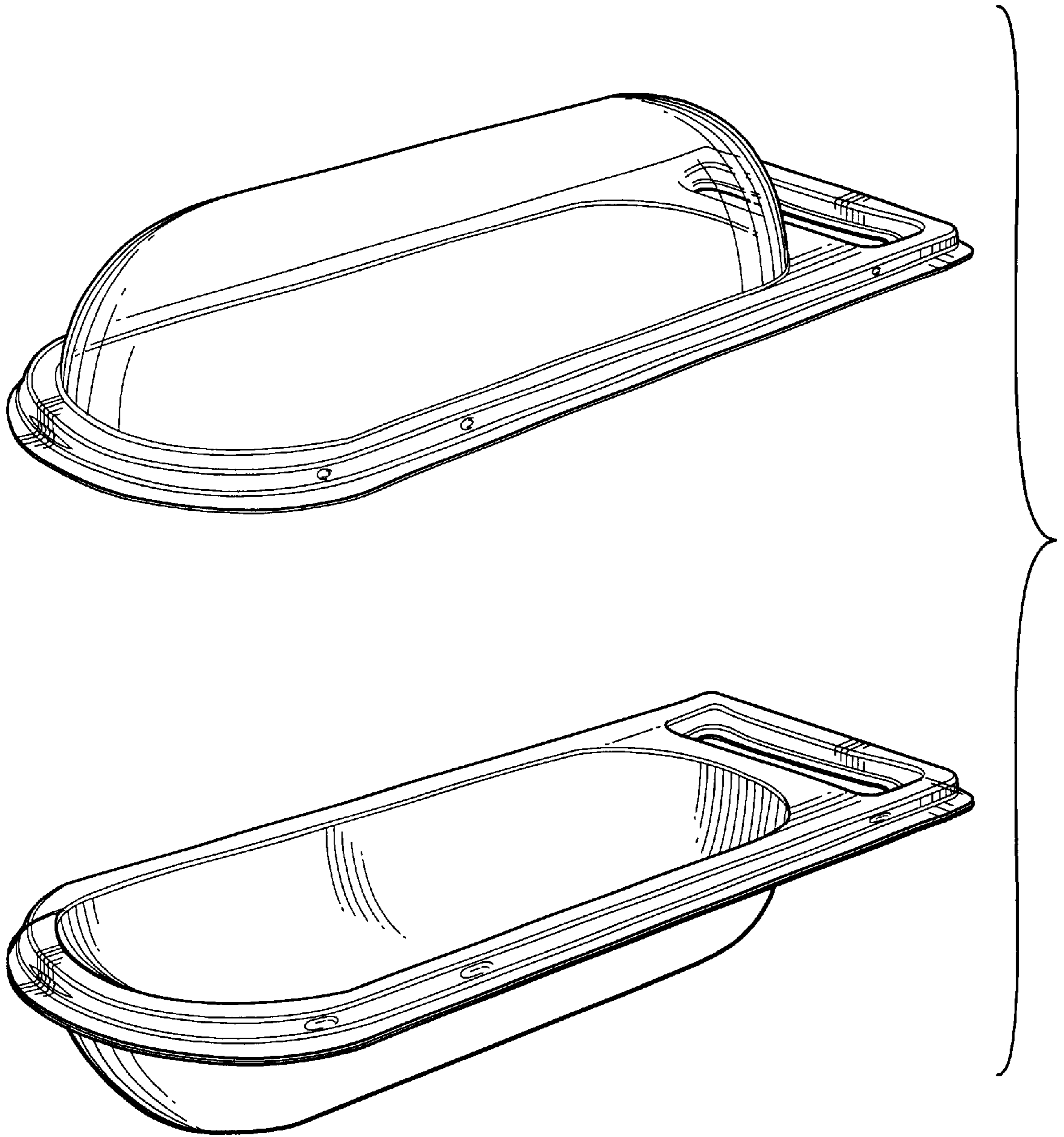

Figure 9

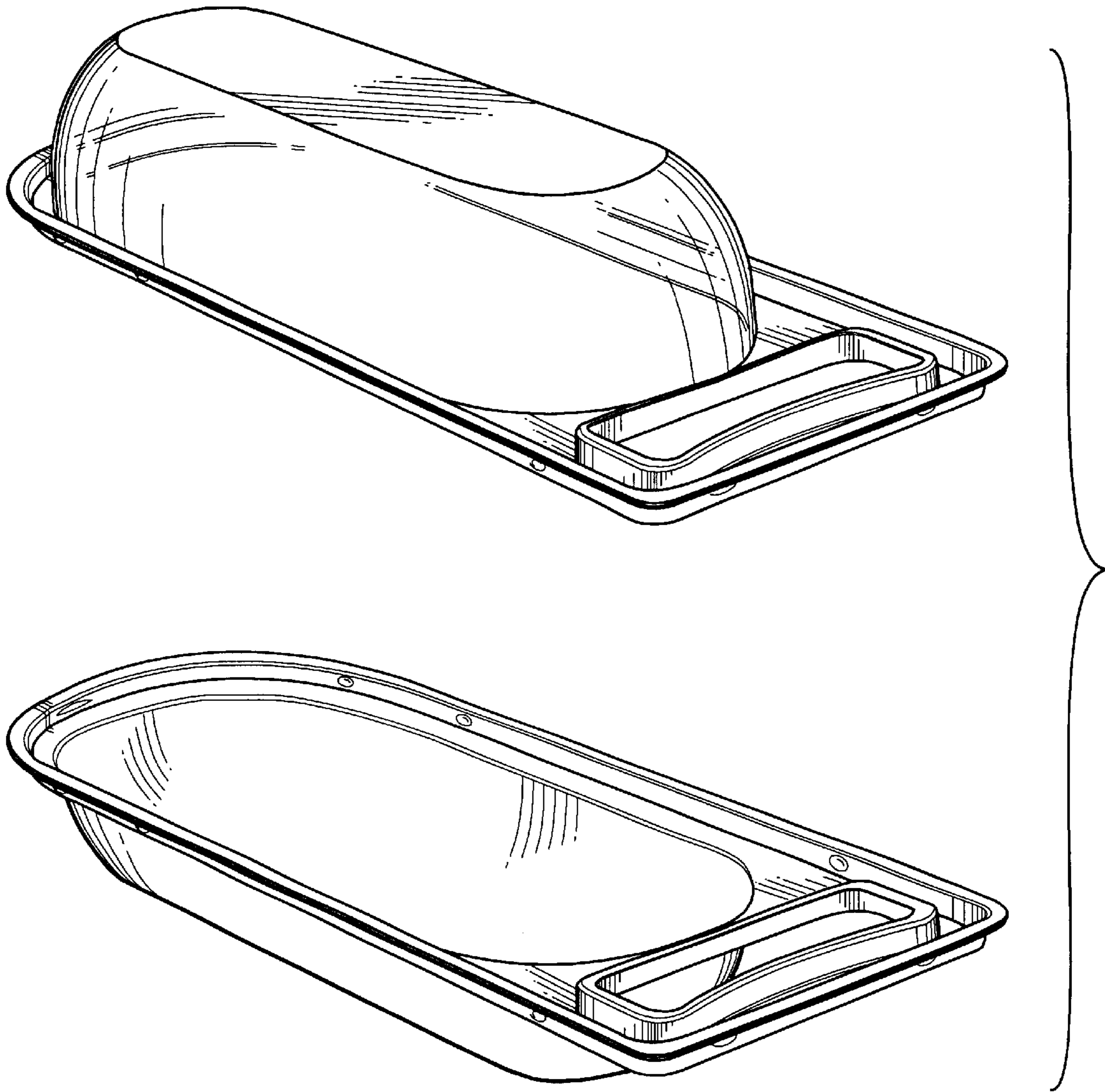

Figure 10

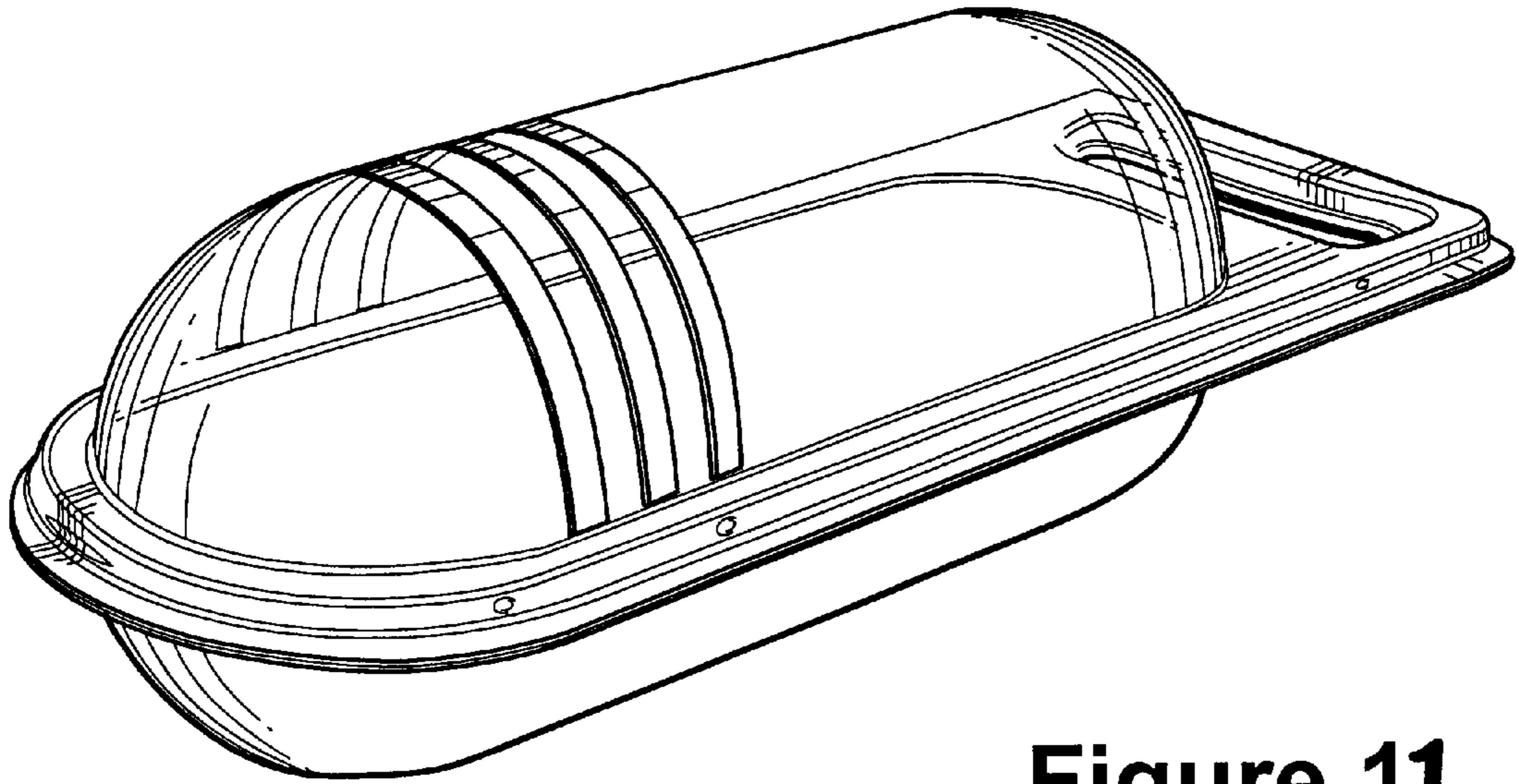

Figure 11

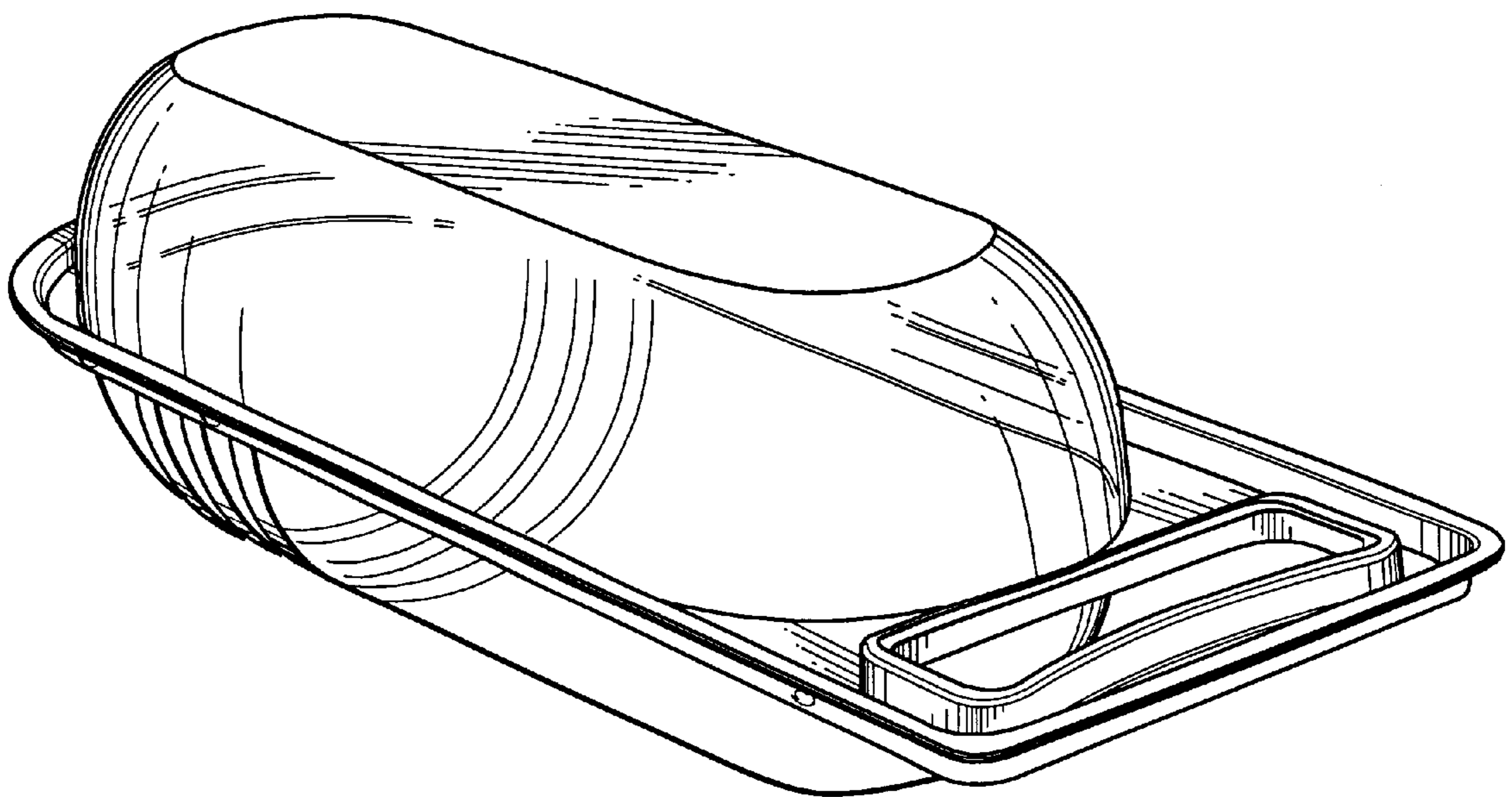

Figure 12

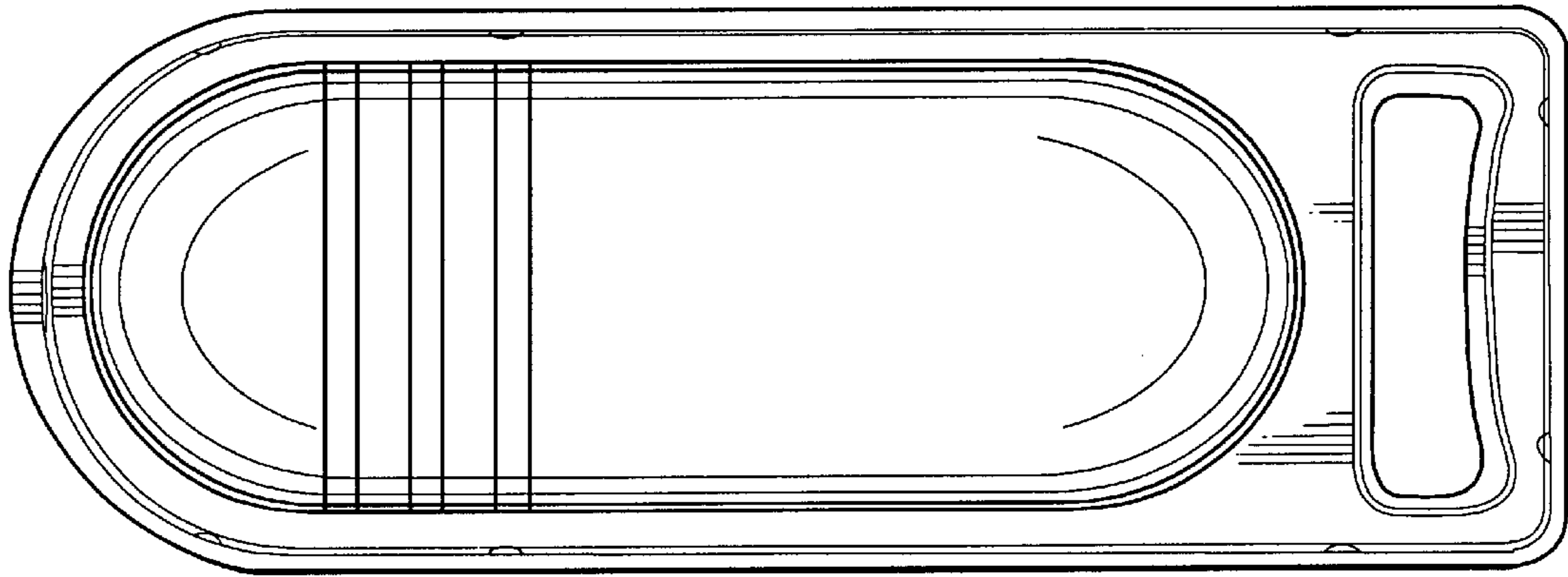

Figure13

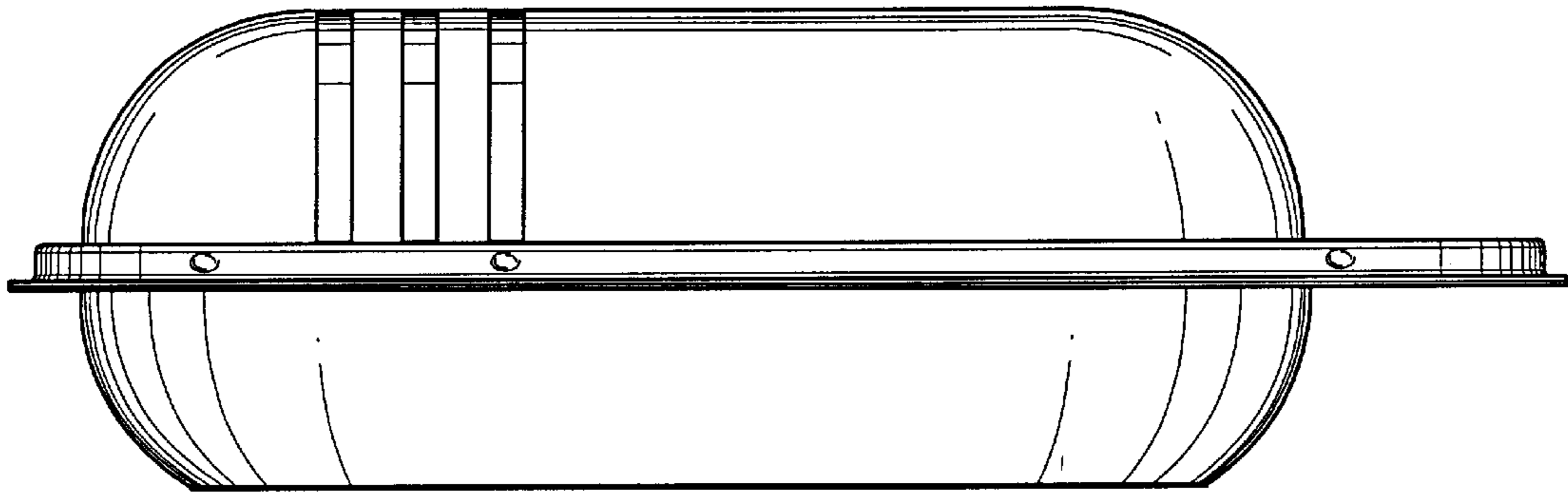

Figure14

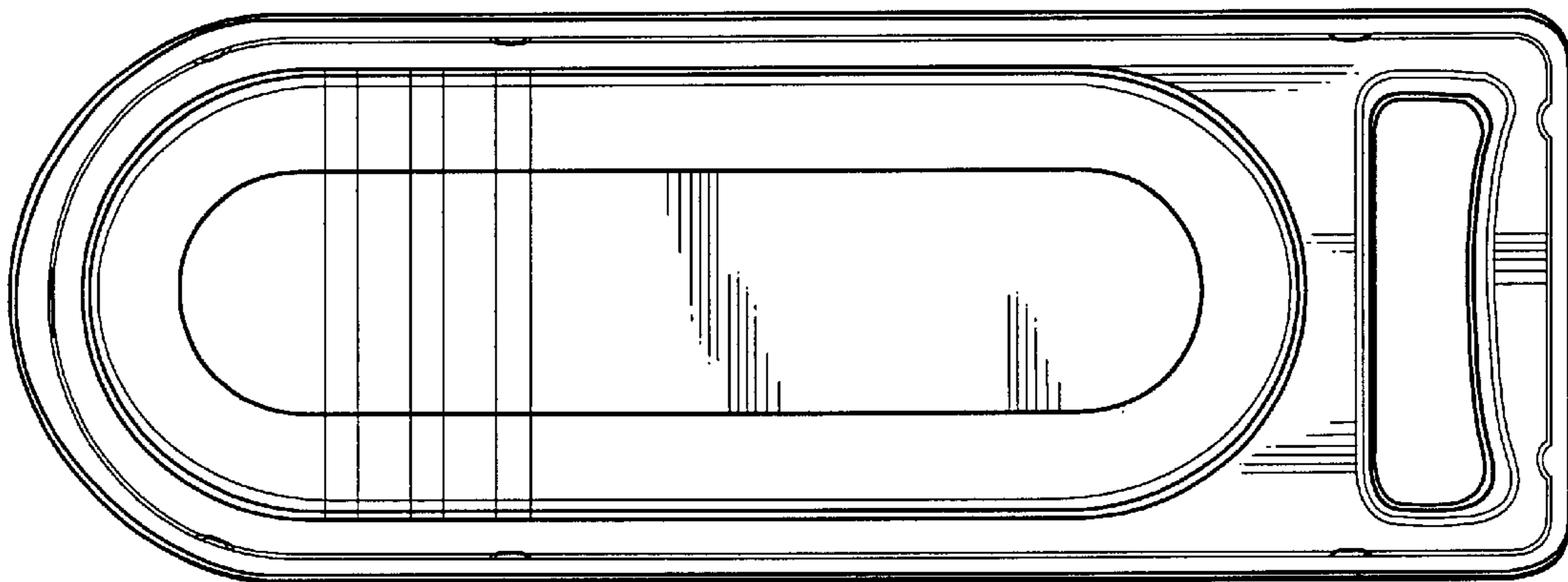

Figure15

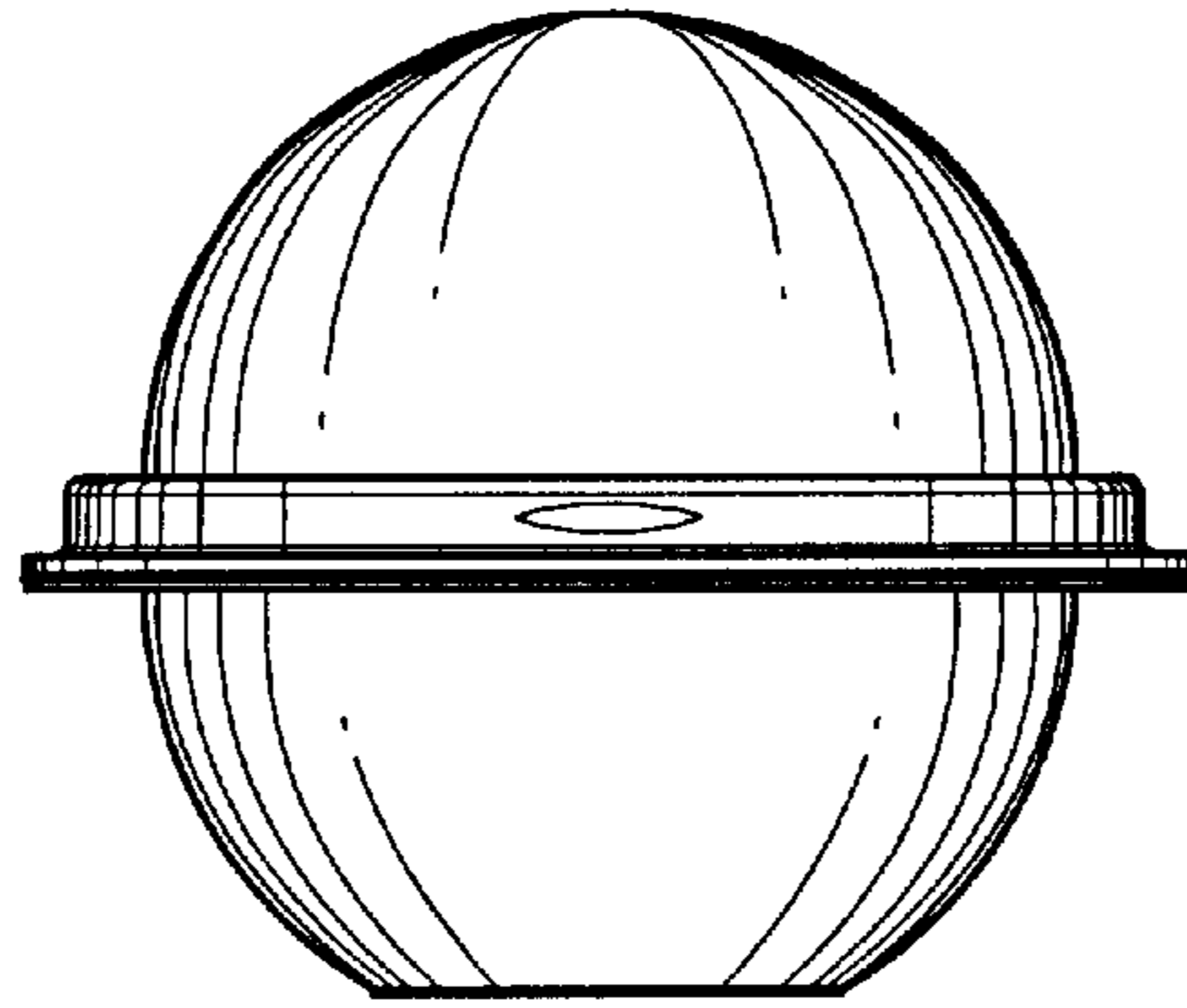

Figure 16

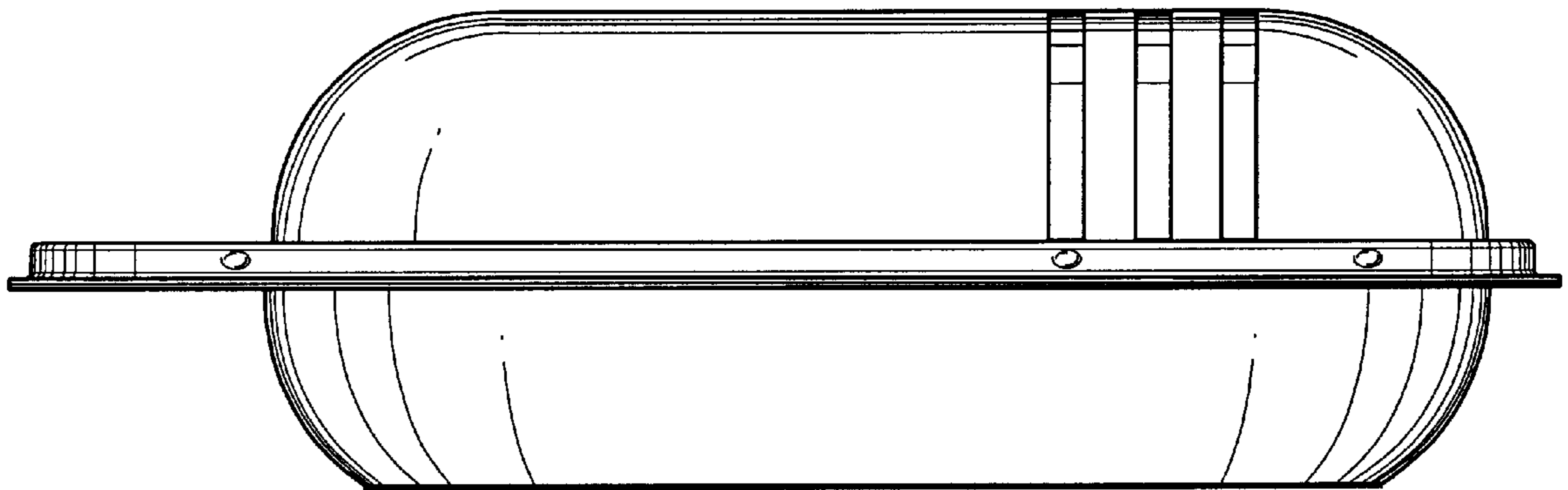

Figure 17

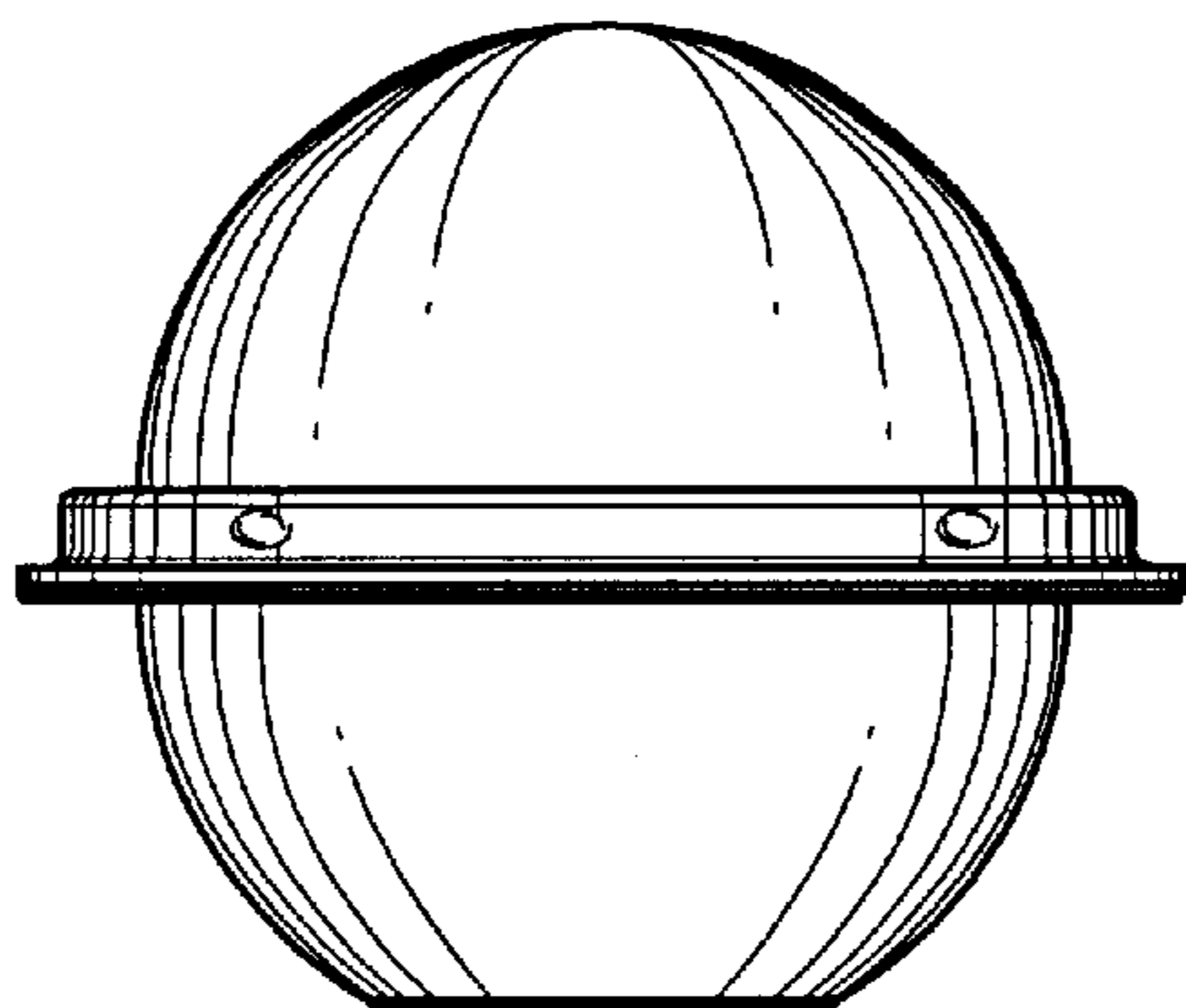

Figure 18

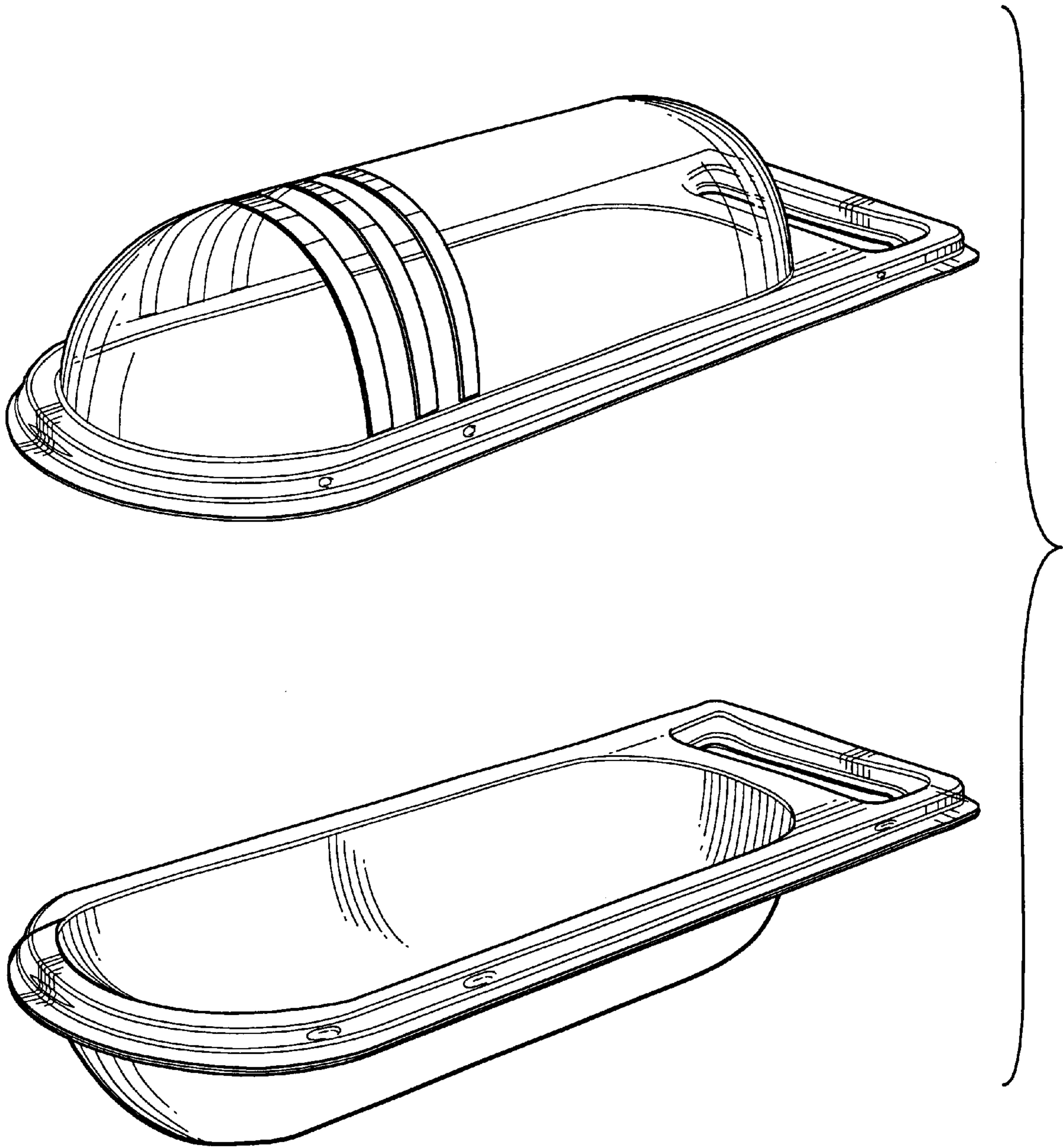

Figure 19

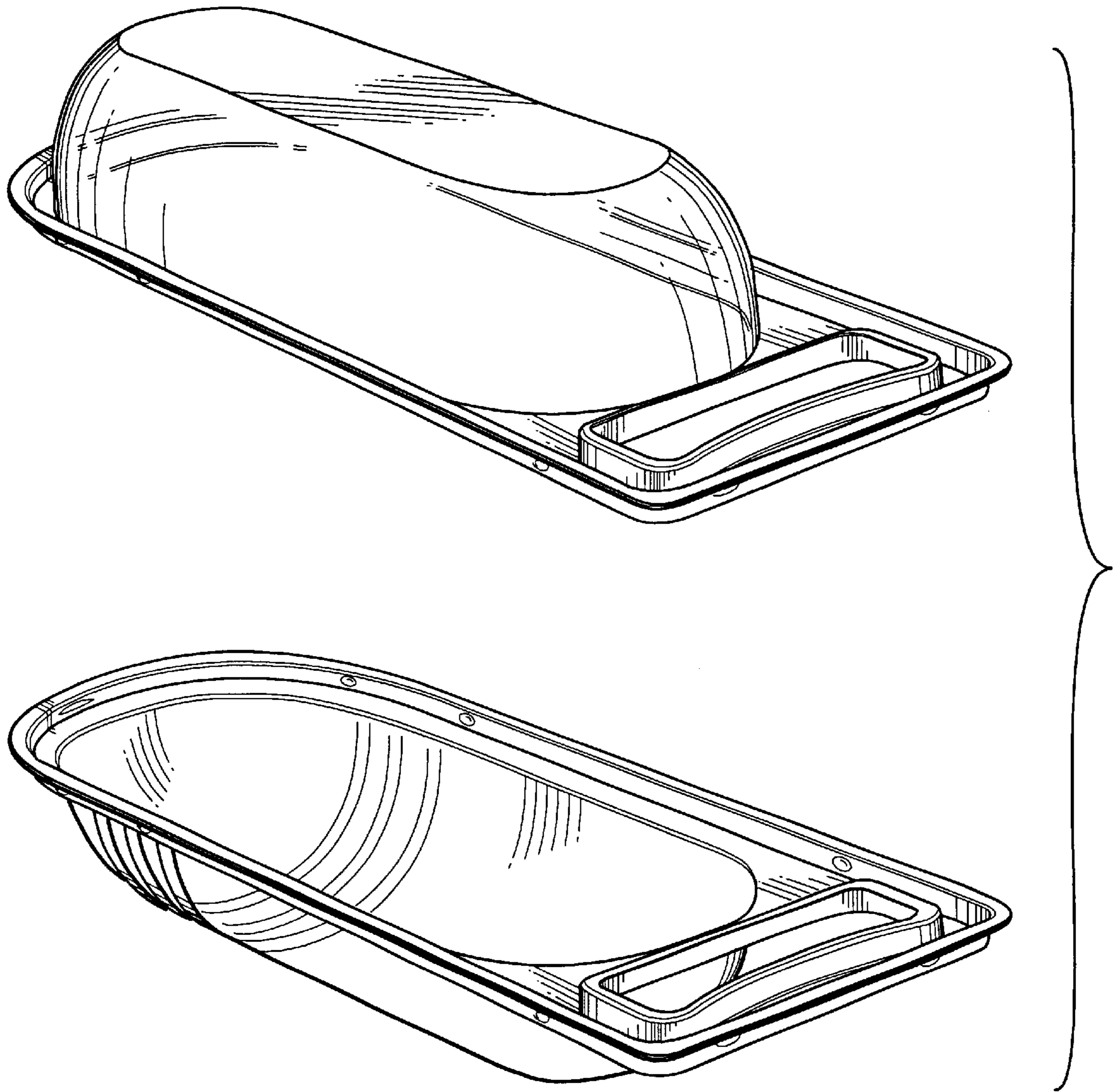

Figure 20