



US00D449087B1

(12) **United States Design Patent**
D'Ambrosio

(10) **Patent No.:** **US D449,087 S**

(45) **Date of Patent:** **** Oct. 9, 2001**

(54) **PUTTER FACE FOR A PUTTER HEAD**

(76) Inventor: **Carlo D'Ambrosio**, 8446 Des Rapides,
Lasalle, Quebec (CA), H8P 2V7

(**) Term: **14 Years**

(21) Appl. No.: **29/133,862**

(22) Filed: **Dec. 8, 2000**

(51) **LOC (7) Cl.** **21-02**

(52) **U.S. Cl.** **D21/759**

(58) **Field of Search** D21/736-746,
D21/753, 759; 473/324, 251-256, 340,
341, 329-331

(56) **References Cited**

U.S. PATENT DOCUMENTS

- D. 285,818 * 9/1986 Moore D21/741
- D. 335,694 * 5/1993 Stuff D21/744
- D. 400,944 * 11/1998 Antonious D21/753
- D. 431,853 * 10/2000 Antonious D21/759

* cited by examiner

Primary Examiner—Mitchell Siegel

(74) *Attorney, Agent, or Firm*—Notaro & Michalos P.C.

(57) **CLAIM**

The ornamental design for a putter face for a putter head, as shown and described.

DESCRIPTION

FIG. 1 is an upper frontal perspective view showing my new design for the putting face for a putter head;
FIG. 2 is a front elevational view thereof;
FIG. 3 is a top plan view thereof;
FIG. 4 is a bottom plan view thereof;
FIG. 5 is a rear elevational view thereof;
FIG. 6 is a right side elevational view thereof; and,
FIG. 7 is a left side elevational view thereof.

The portions of the putter head shown in broken lines in FIGS. 1 to 7 do not form part of the present design.
The club shaft shown in broken lines in the drawings does not form part of the present design.

1 Claim, 2 Drawing Sheets

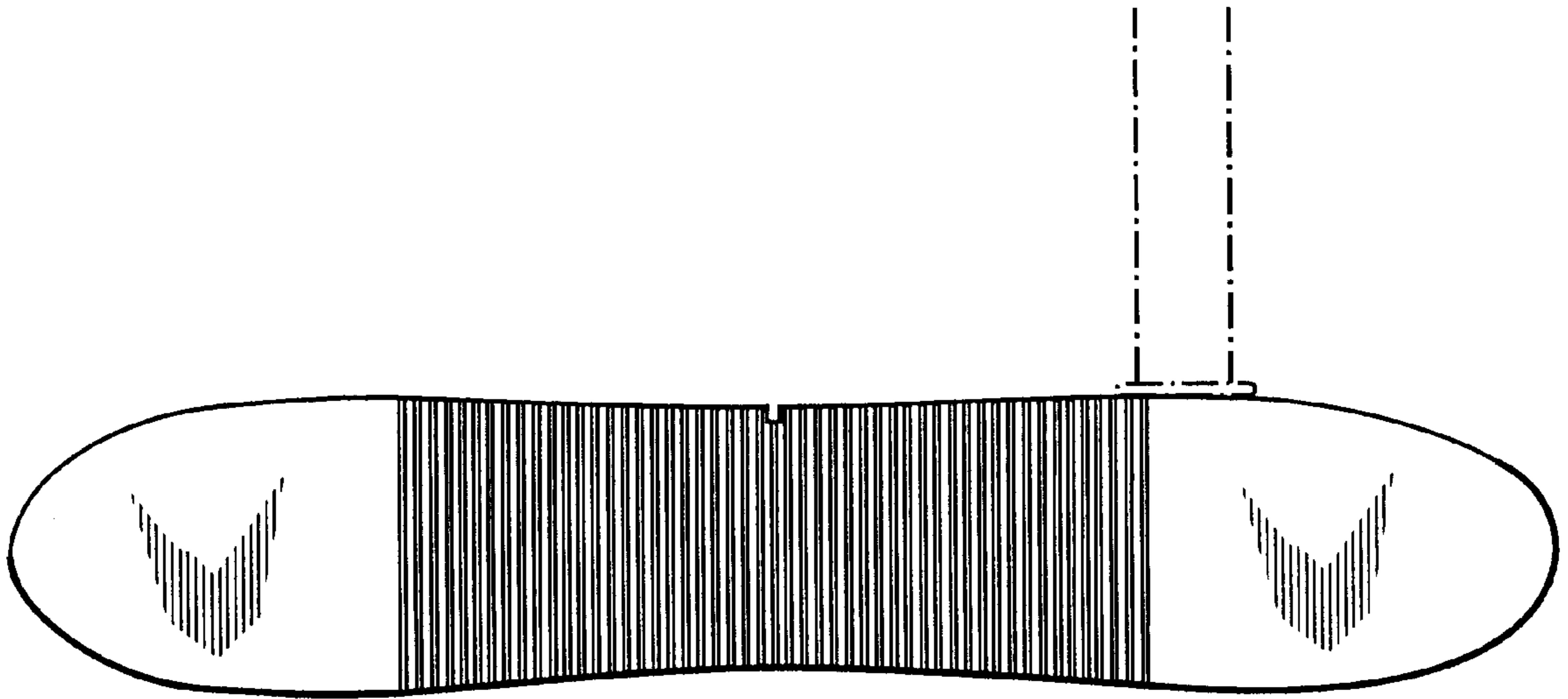

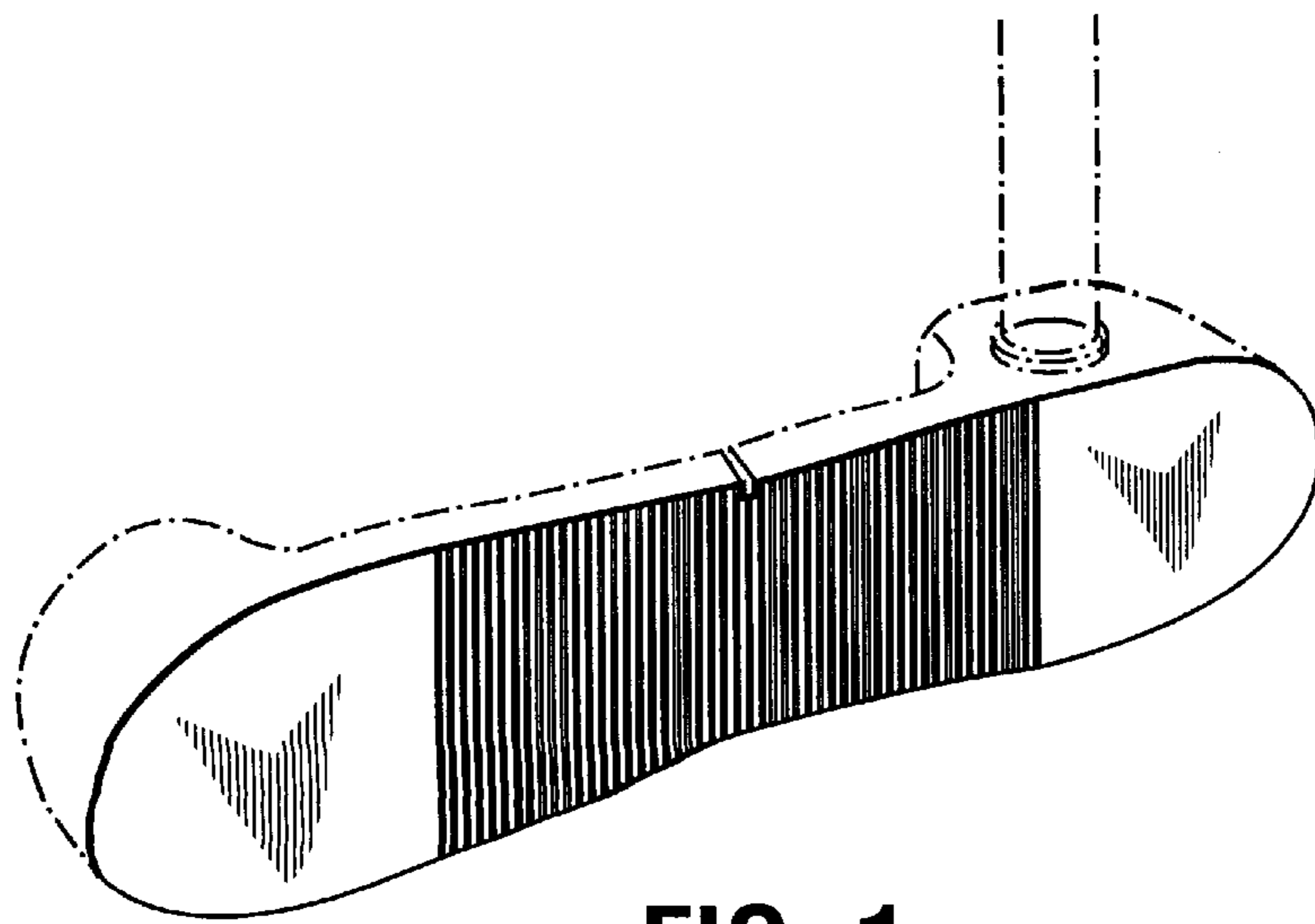

FIG. 1

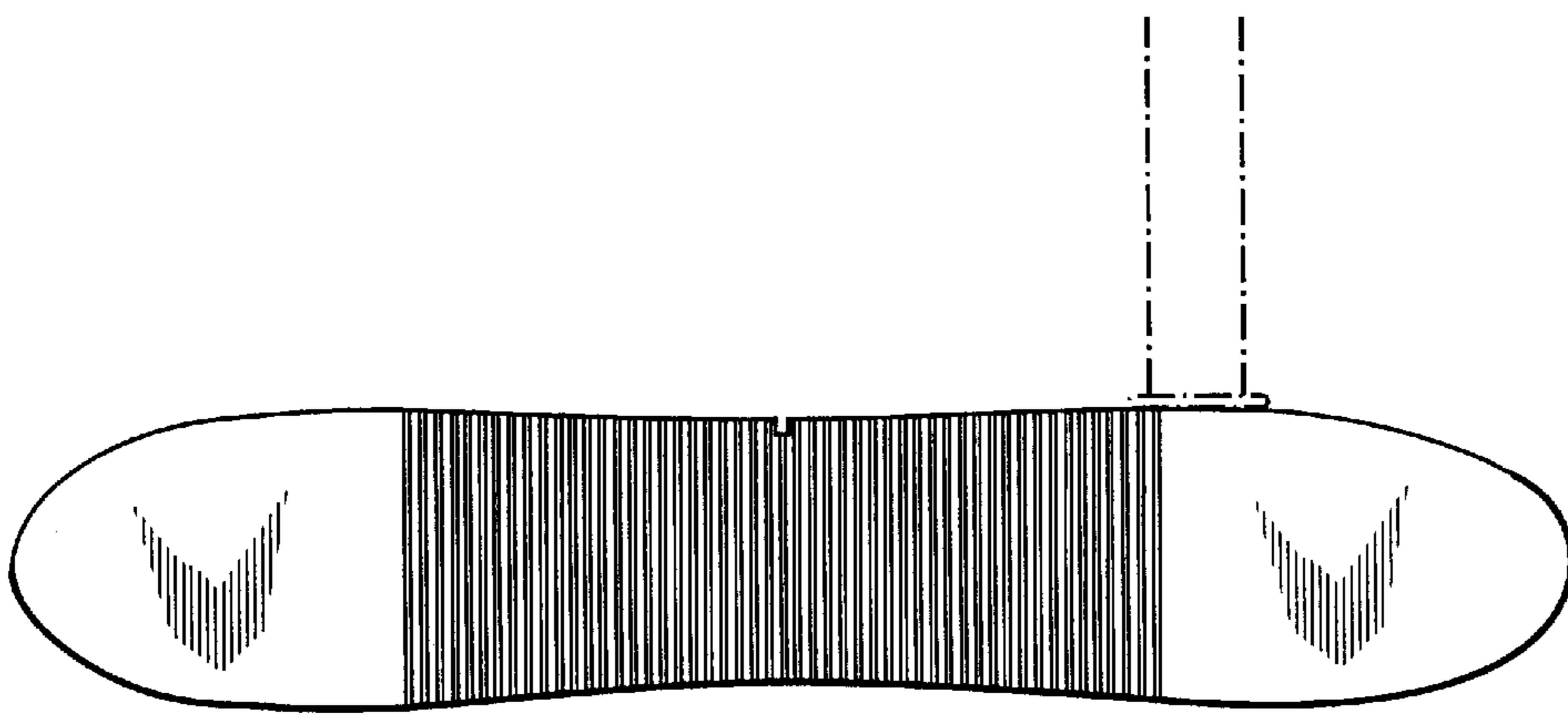

FIG. 2

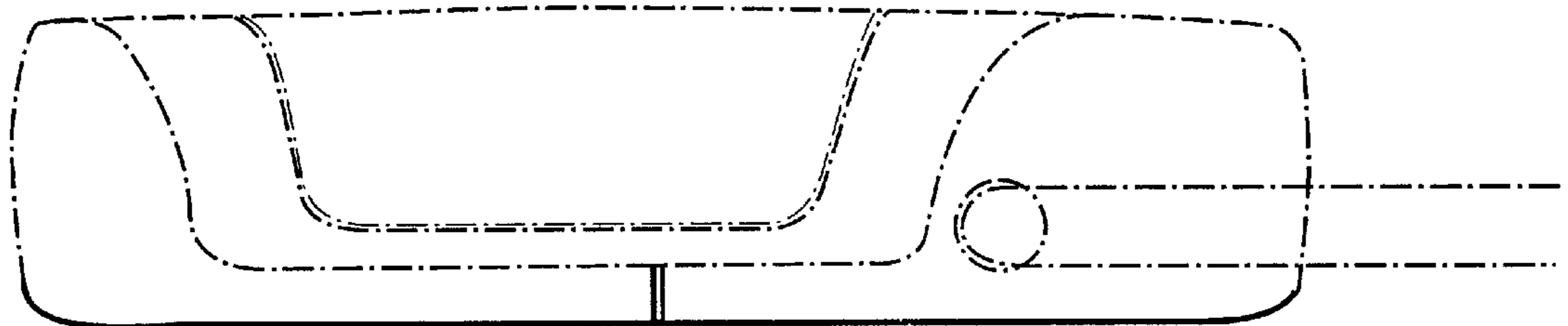

FIG. 3

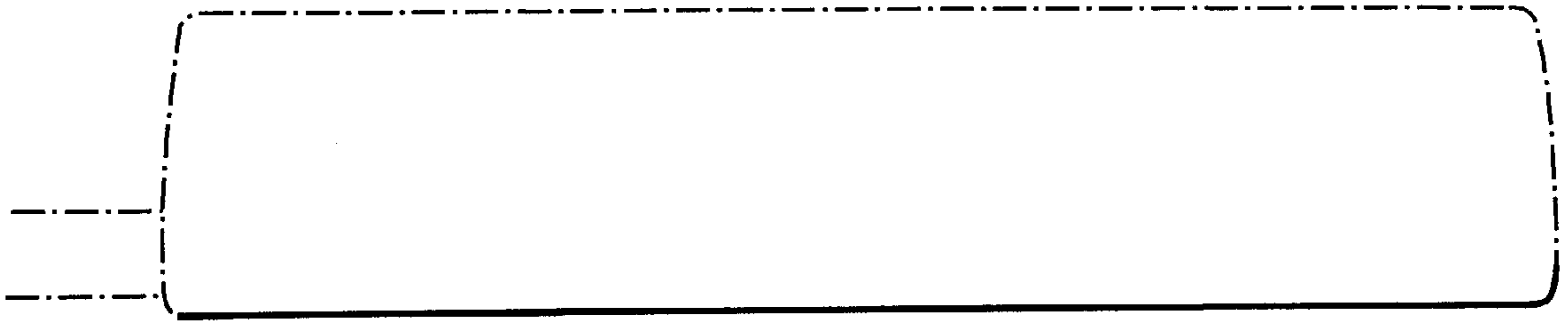

FIG. 4

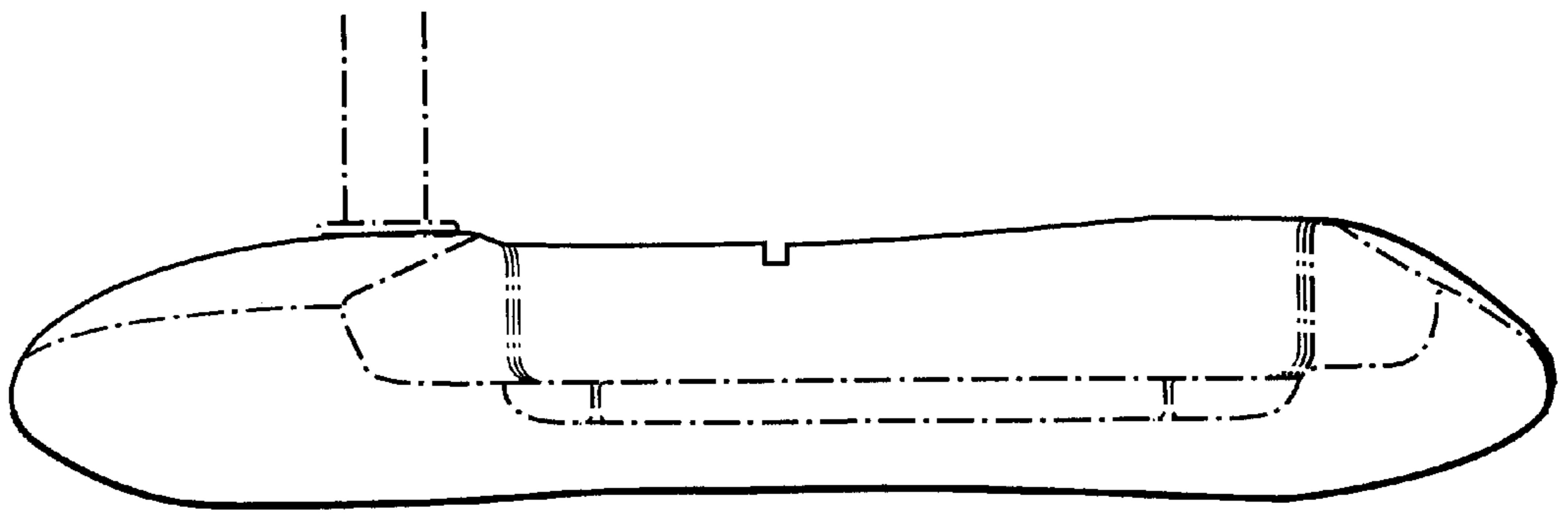

FIG. 5

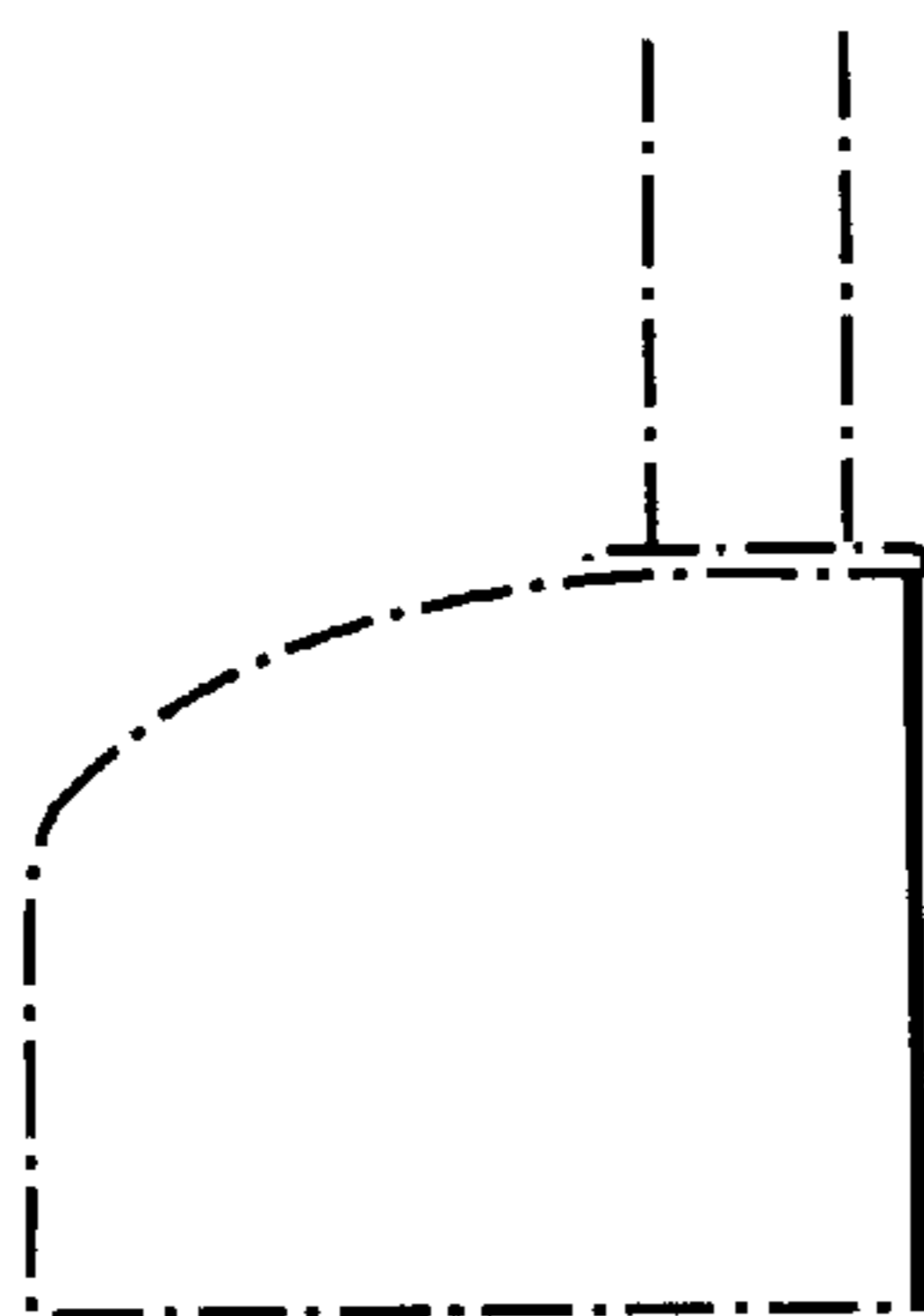

FIG. 6

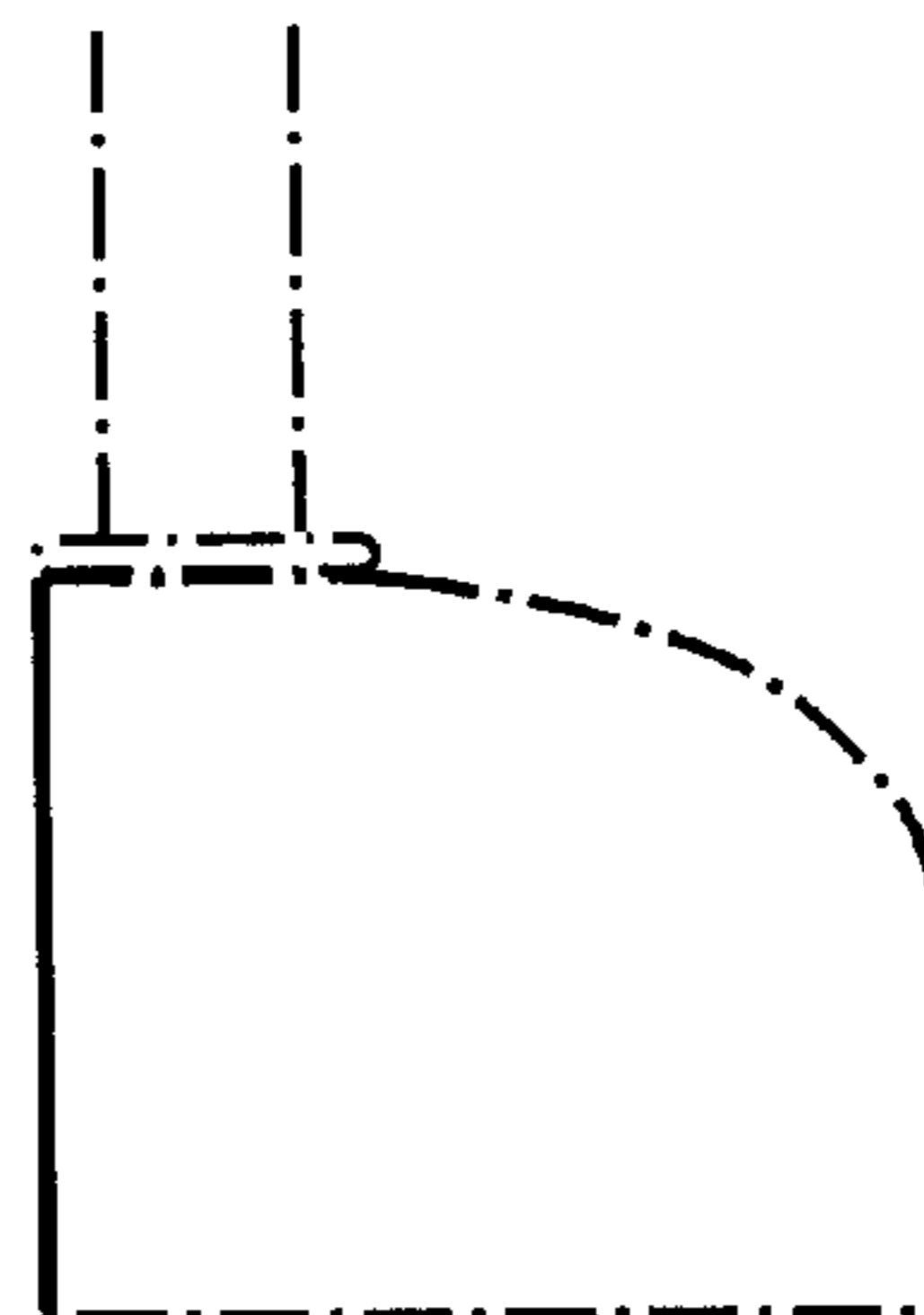

FIG. 7