



US00D449086B1

(12) **United States Design Patent**  
**Nagai et al.**

(10) **Patent No.:** **US D449,086 S**

(45) **Date of Patent:** **\*\* Oct. 9, 2001**

(54) **RECESSED BACK PORTION OF A GOLF CLUB HEAD**

5,014,993 \* 5/1991 Antonious ..... 473/350  
5,921,869 \* 7/1999 Blough et al. .... 473/350

(75) Inventors: **Masao Nagai**, Dunwoody, GA (US);  
**Toshiyuki Nagasaki**, Osaka (JP); **David Llewellyn**, Norcross, GA (US); **Harry Taylor**, Old Hickory, TN (US)

\* cited by examiner

*Primary Examiner*—Mitchell Siegel  
(74) *Attorney, Agent, or Firm*—Troutman Sanders LLP;  
Gerald R. Boss

(73) Assignee: **Mizuno Corporation**, Norcross, GA (US)

(57) **CLAIM**

(\*\*) Term: **14 Years**

The ornamental design for a recessed back portion of a golf club head, as shown and described.

(21) Appl. No.: **29/127,059**

**DESCRIPTION**

(22) Filed: **Jul. 28, 2000**

(51) **LOC (7) Cl.** ..... **21-02**

(52) **U.S. Cl.** ..... **D21/759**

(58) **Field of Search** ..... D21/747-751,  
D21/753, 759; 473/324, 327, 350

FIG. 1 is a perspective view of a recessed back portion of a golf club head showing our new design;  
FIG. 2 is an elevational view thereof;  
FIG. 3 is a cross-sectional view taken along lines 3—3 of FIG. 2;  
FIG. 4 is a toe side view thereof;  
FIG. 5 is a cross-sectional view taken along lines 5—5 of FIG. 2;  
FIG. 6 is a cross-sectional view taken along lines 6—6 of FIG. 2; and,  
FIG. 7 is a cross-sectional view taken along lines 7—7 of FIG. 2.

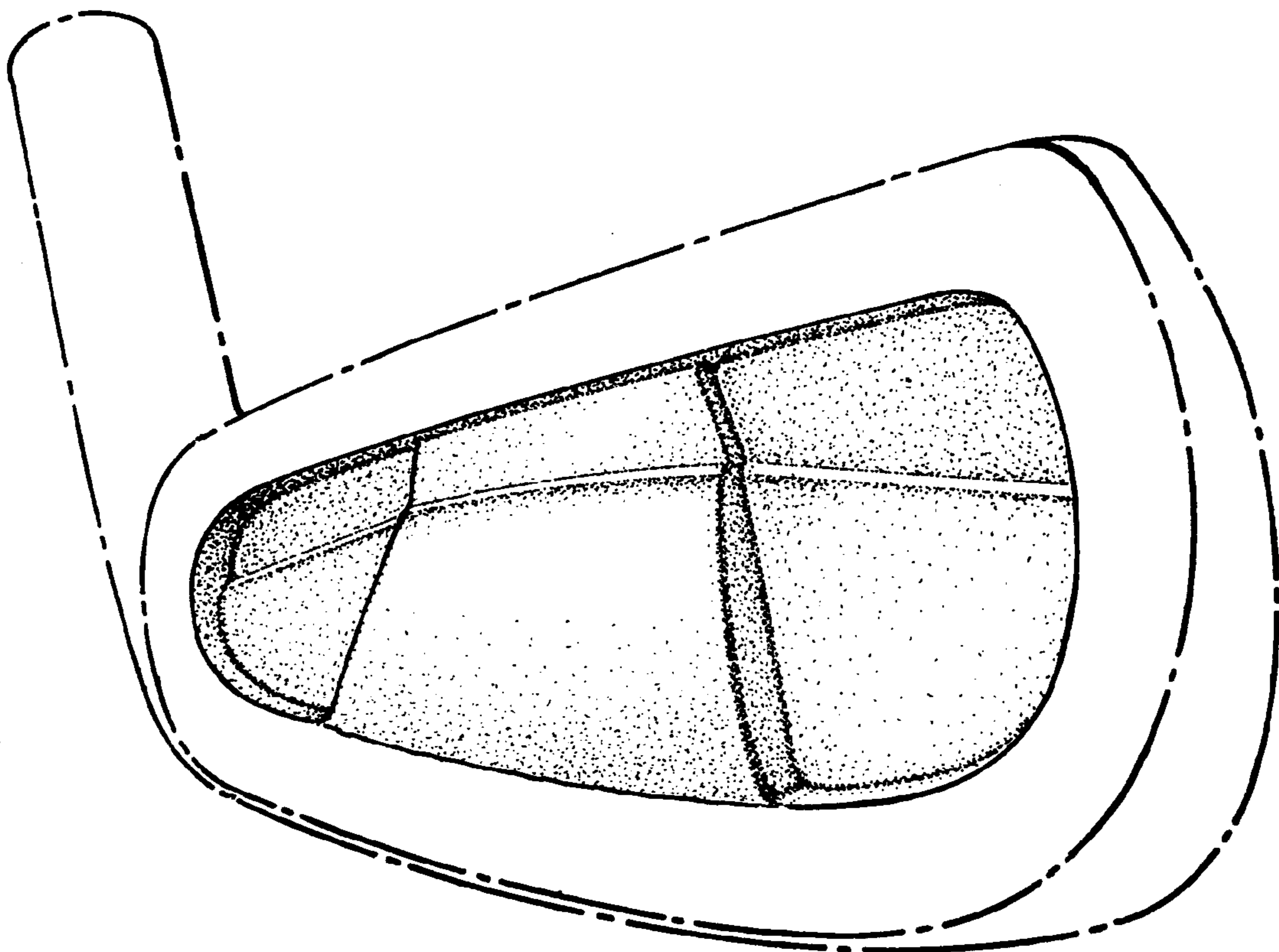
(56) **References Cited**

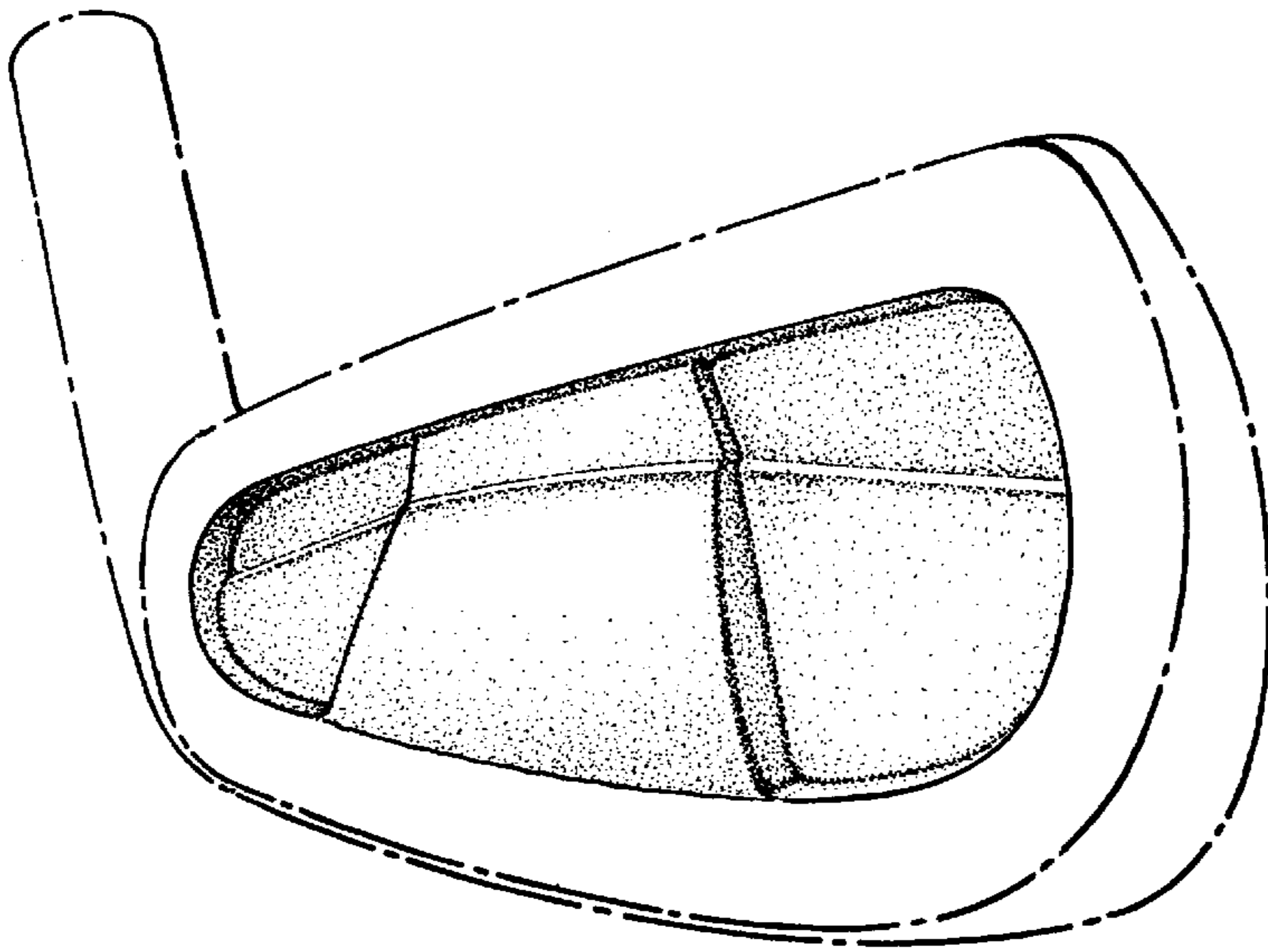
**U.S. PATENT DOCUMENTS**

- D. 329,266 \* 9/1992 Antonious ..... D21/749
- D. 377,381 \* 1/1997 Takahashi et al. .... D21/748
- D. 383,820 9/1997 Watanabe .
- D. 428,634 \* 7/2000 Nagai et al. .... D21/759
- D. 428,635 \* 7/2000 Nagai et al. .... D21/759
- D. 435,278 \* 12/2000 Reed et al. .... D21/747

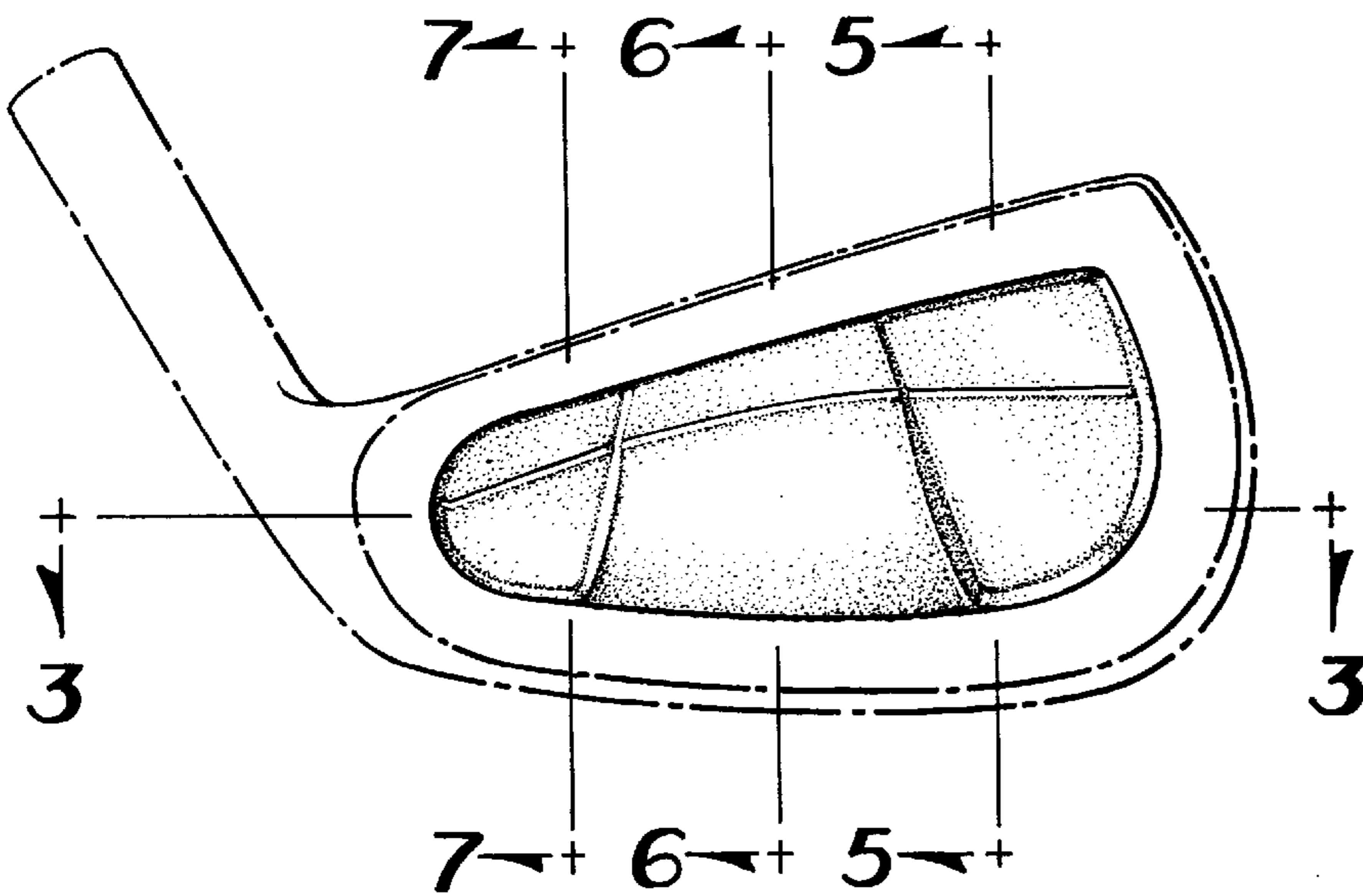
The broken line showing of a golf club had is for illustrative purposes only and forms no part of the claimed design.

**1 Claim, 2 Drawing Sheets**

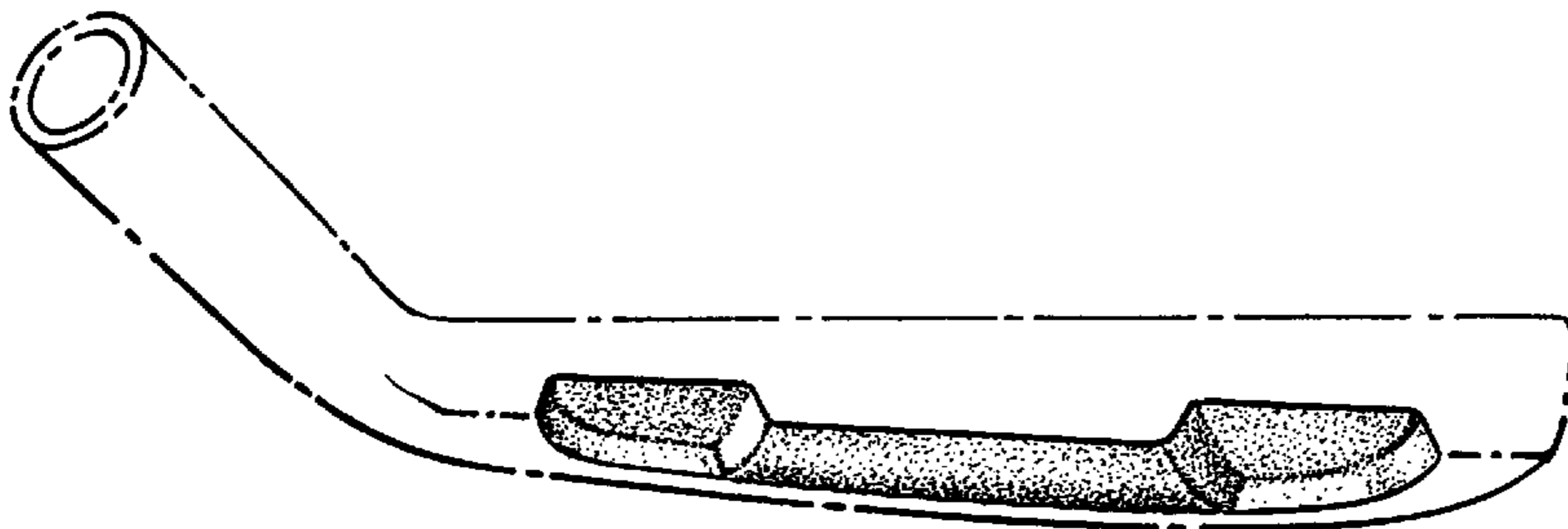




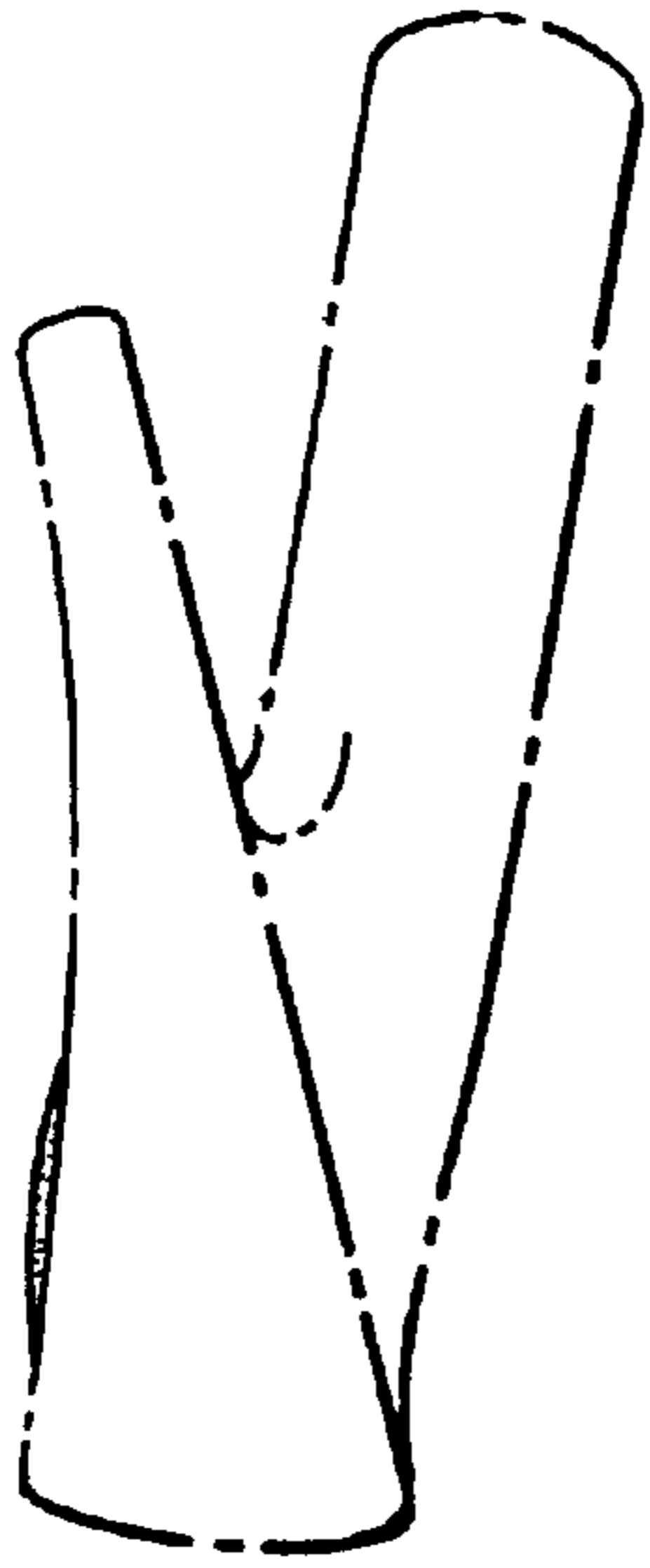
**FIG 1**



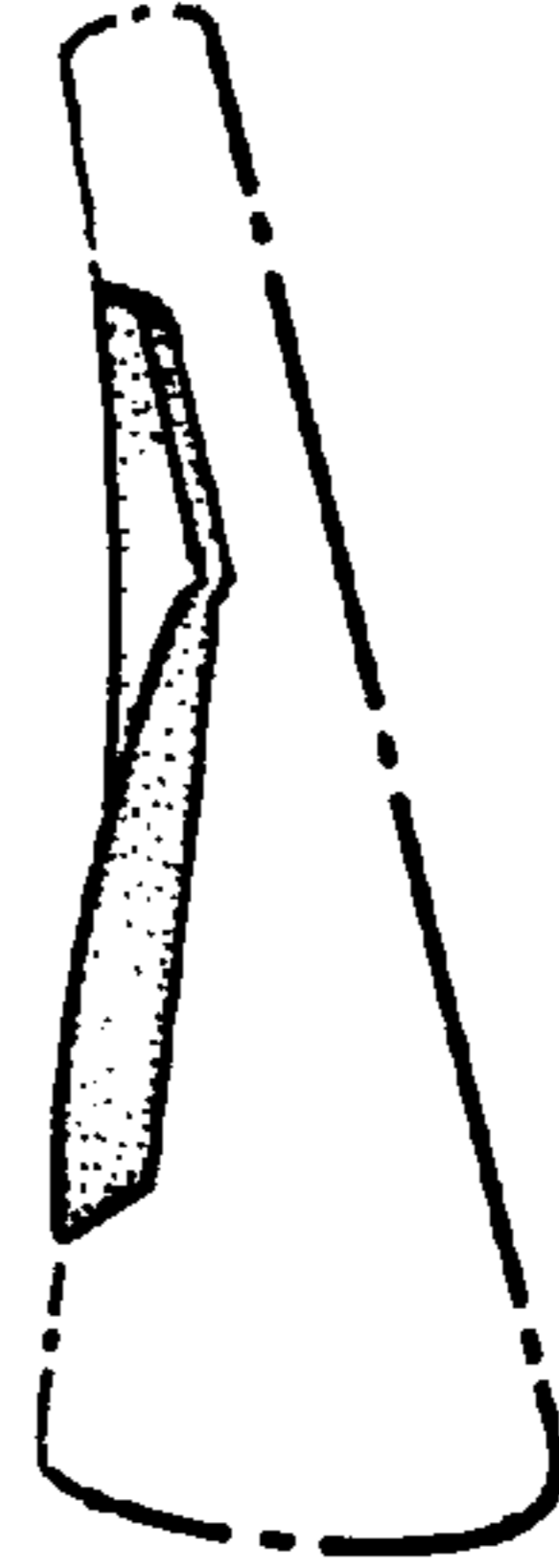
**FIG 2**



**FIG 3**



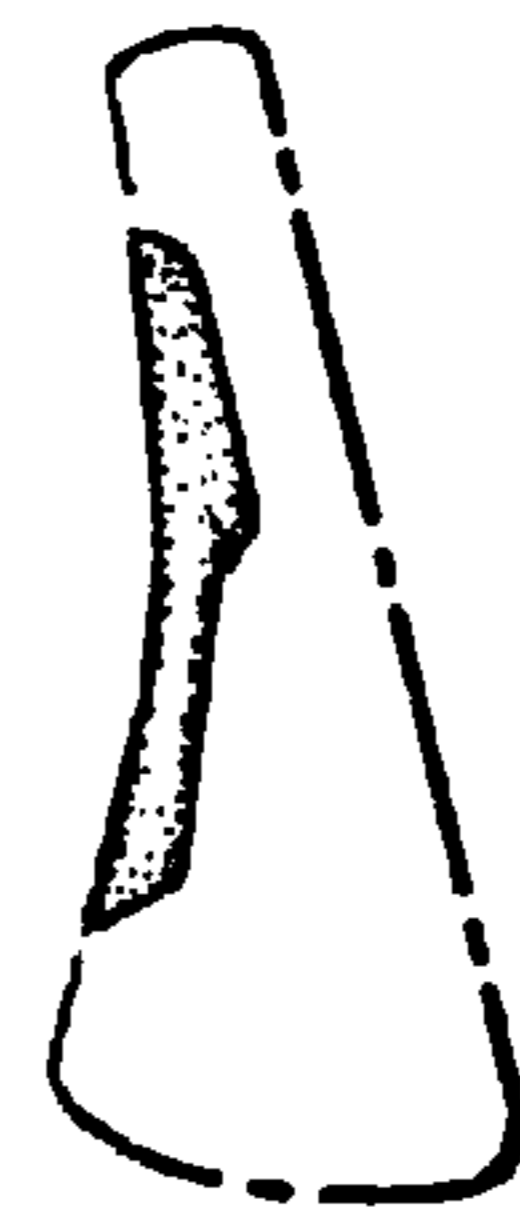
**FIG 4**



**FIG 5**



**FIG 6**



**FIG 7**