



US00D449073B1

(12) **United States Design Patent**
Oka et al.

(10) **Patent No.:** **US D449,073 S**

(45) **Date of Patent:** **** Oct. 9, 2001**

(54) **CASE FOR REFILLABLE LEADS FOR A MECHANICAL PENCIL**

(75) Inventors: **Shigeo Oka**, Tokyo; **Kazunari Takahashi**, Yashio, both of (JP)

(73) Assignee: **Pentel Kabushiki Kaisha (JP)**

(**) Term: **14 Years**

(21) Appl. No.: **29/098,712**

(22) Filed: **Jan. 5, 1999**

(30) **Foreign Application Priority Data**

Jul. 6, 1998 (JP) 10-19460

(51) **LOC (7) Cl.** **19-06**

(52) **U.S. Cl.** **D19/75; D19/85**

(58) **Field of Search** D3/206; D9/425, D9/337, 339; D19/75, 77, 81-85, 65, 99, 100, 43, 49; 206/369, 214, 443, 438, 718; 221/248-250, 247, 312 C; 401/60, 55-59

(56) **References Cited**

U.S. PATENT DOCUMENTS

D. 172,277	*	5/1954	Hanle	D9/425
3,648,891	*	3/1972	Katz et al.	221/248
3,815,734	*	6/1974	Kruckel	206/443
4,109,788	*	8/1978	Hirose et al.	206/718
4,445,611	*	5/1984	Shofu	206/369
4,811,842	*	3/1989	Sekiya	206/443
5,480,249	*	1/1996	Kageyama et al.	401/60
5,881,878	*	3/1999	Faccioli et al.	206/438

* cited by examiner

Primary Examiner—Martie K. Holtje
(74) *Attorney, Agent, or Firm*—Adams & Wilks

(57) **CLAIM**

The ornamental design for a case for refillable leads for a mechanical pencil, as shown and described.

DESCRIPTION

FIG. 1 is a top, front and left perspective view of a case for refillable leads for a mechanical pencil showing our new design;
 FIG. 2 is a top plan view thereof;
 FIG. 3 is a bottom plan view thereof;
 FIG. 4 is a left side elevational view thereof;
 FIG. 5 is a front elevational view thereof;
 FIG. 6 is a right side elevational view thereof;
 FIG. 7 is a top plan view thereof with the cap opened;
 FIG. 8 is a bottom plan view thereof with the cap opened;
 FIG. 9 is a left side elevational view thereof with the cap opened;
 FIG. 10 is a front elevational view thereof with the cap opened;
 FIG. 11 is a right side elevational view thereof with the cap opened;
 FIG. 12 is a sectional view thereof taken along line 12—12 in FIG. 5;
 FIG. 13 is a sectional view thereof taken along the line 13—13 in FIG. 2; and,
 FIG. 14 is a sectional view thereof taken along line 14—14 in FIG. 7.

1 Claim, 4 Drawing Sheets

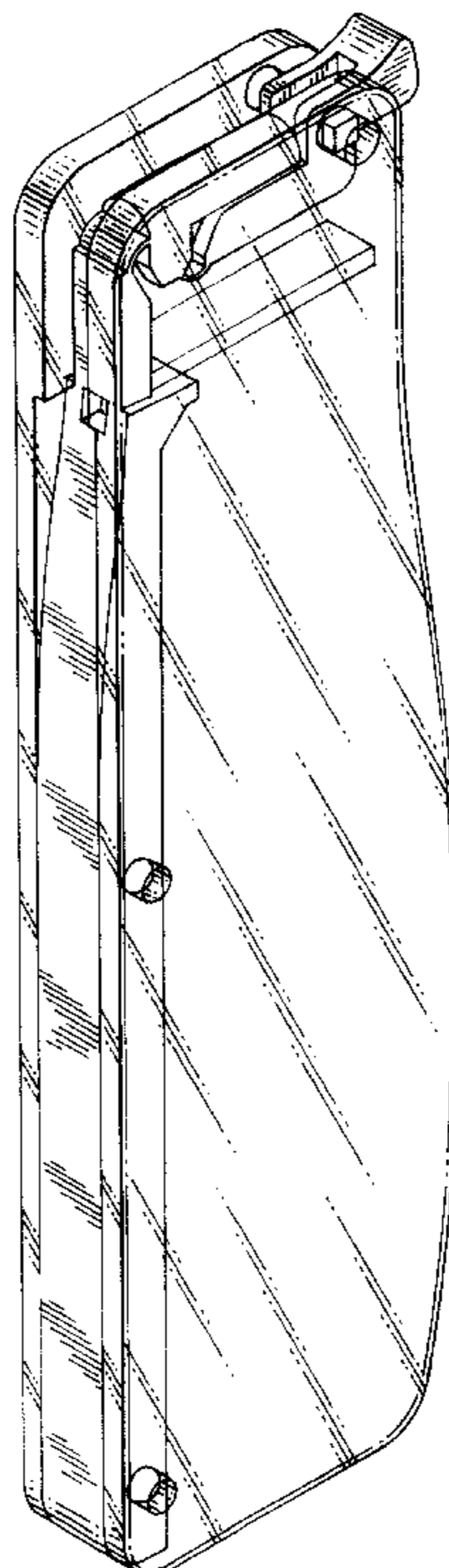

FIG. 1

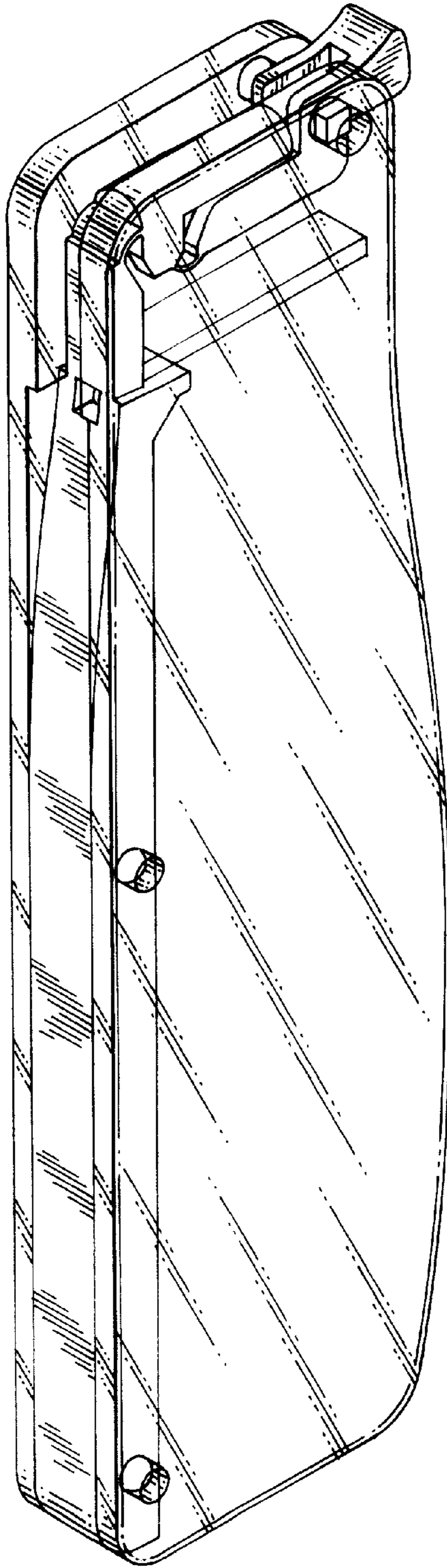

FIG. 2

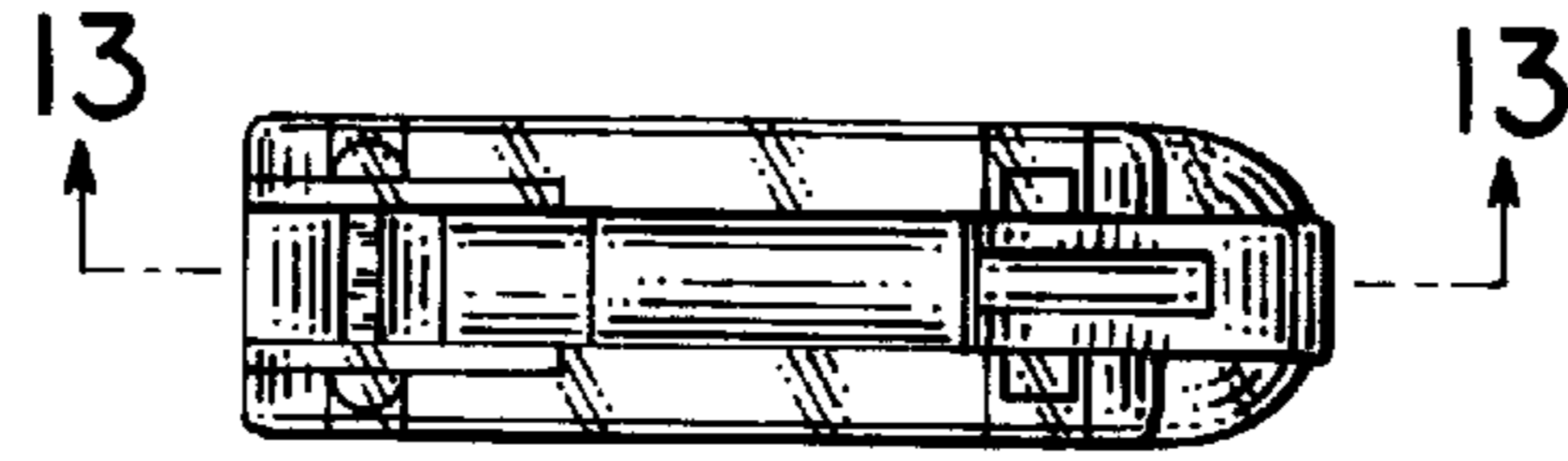

FIG. 3

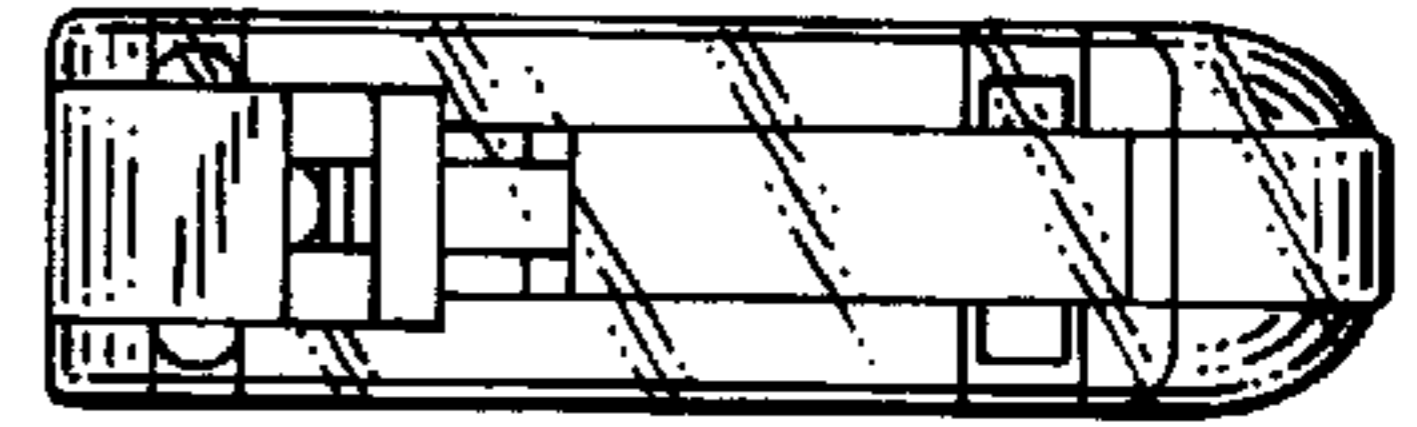

FIG. 4

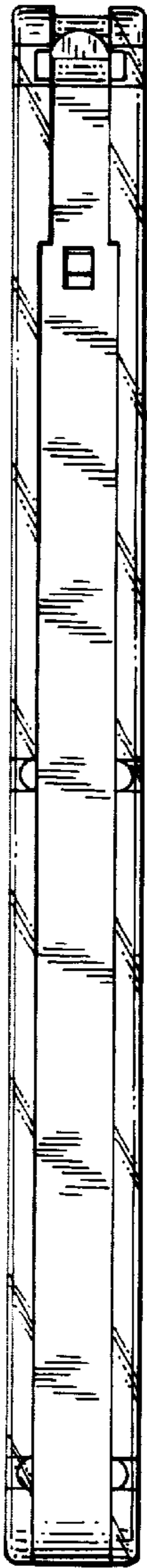

FIG. 5

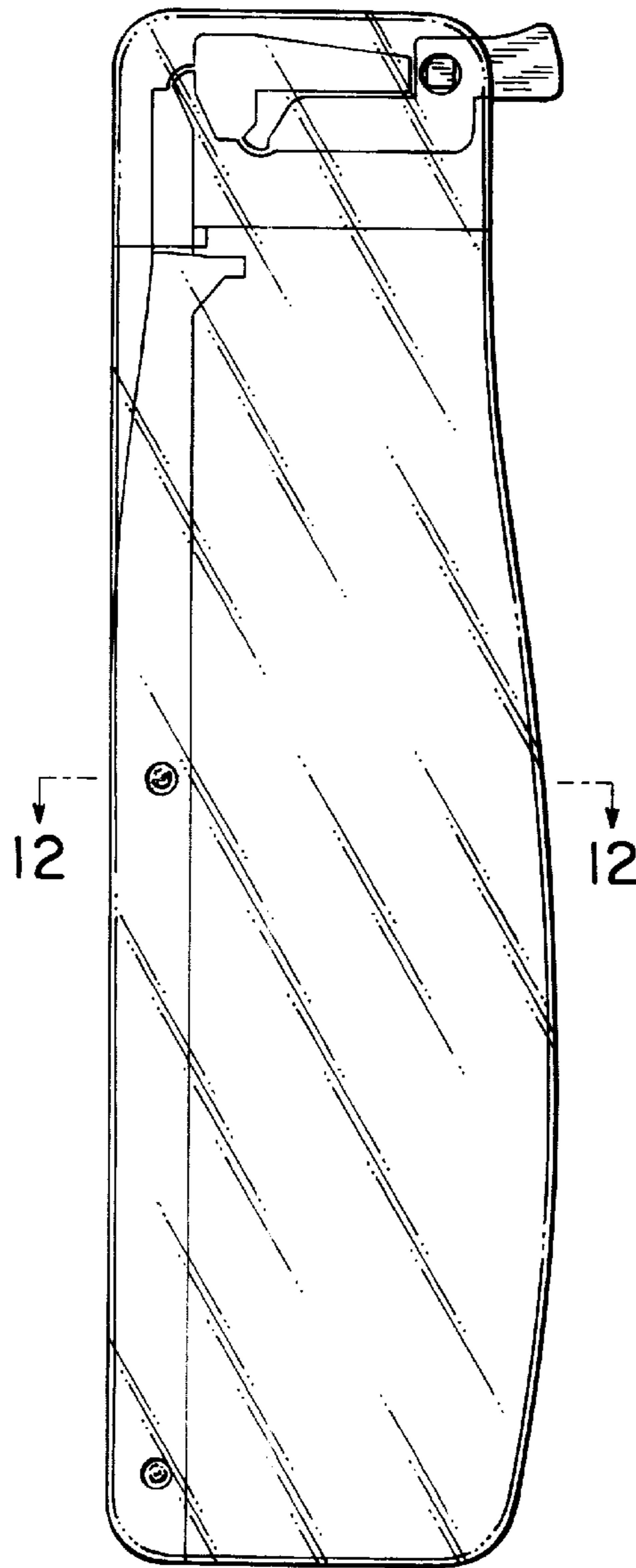

FIG. 6



FIG. 7

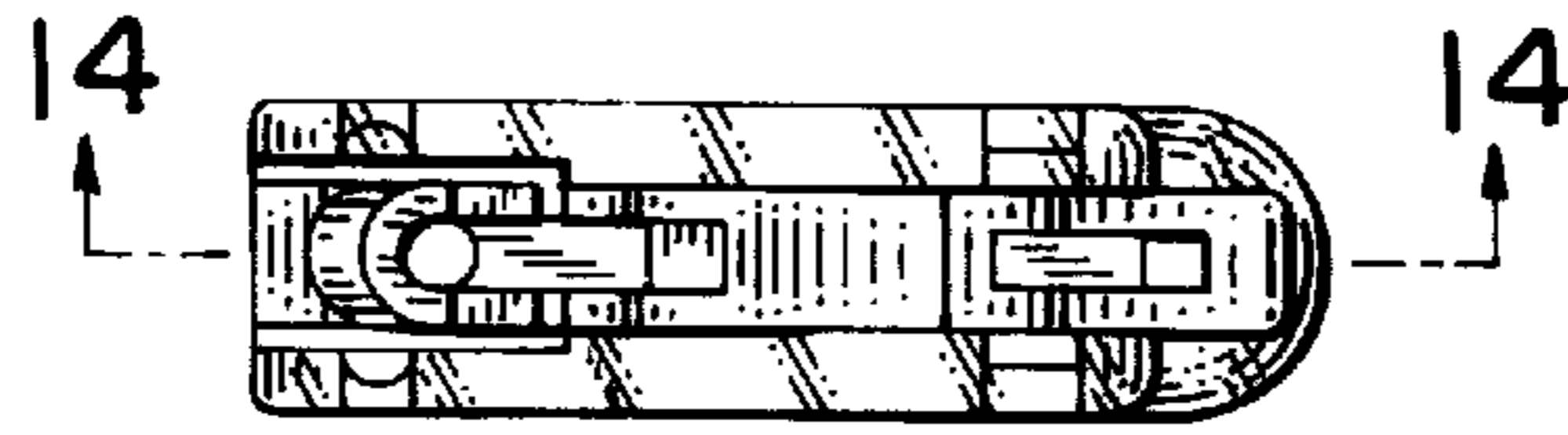

FIG. 8

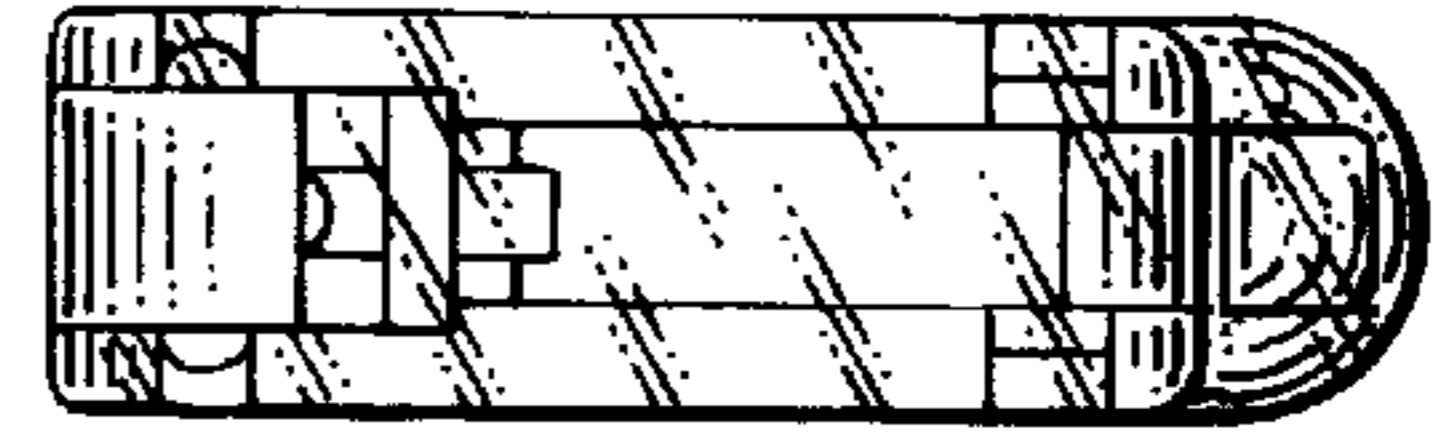

FIG. 9

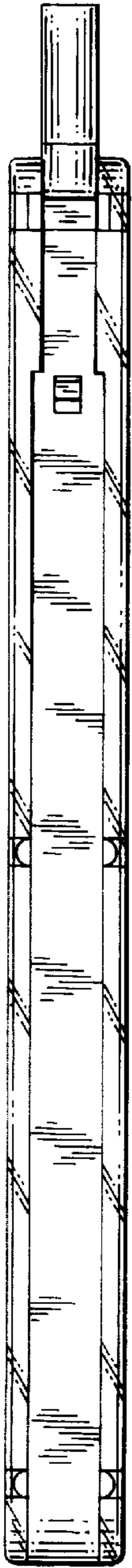

FIG. 10

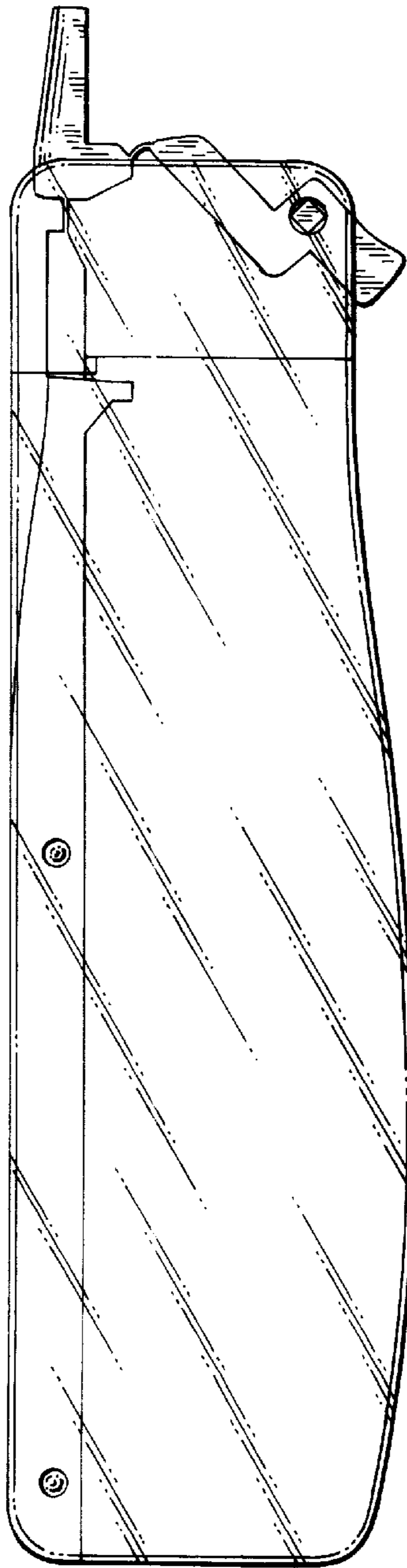

FIG. 11



FIG. 12

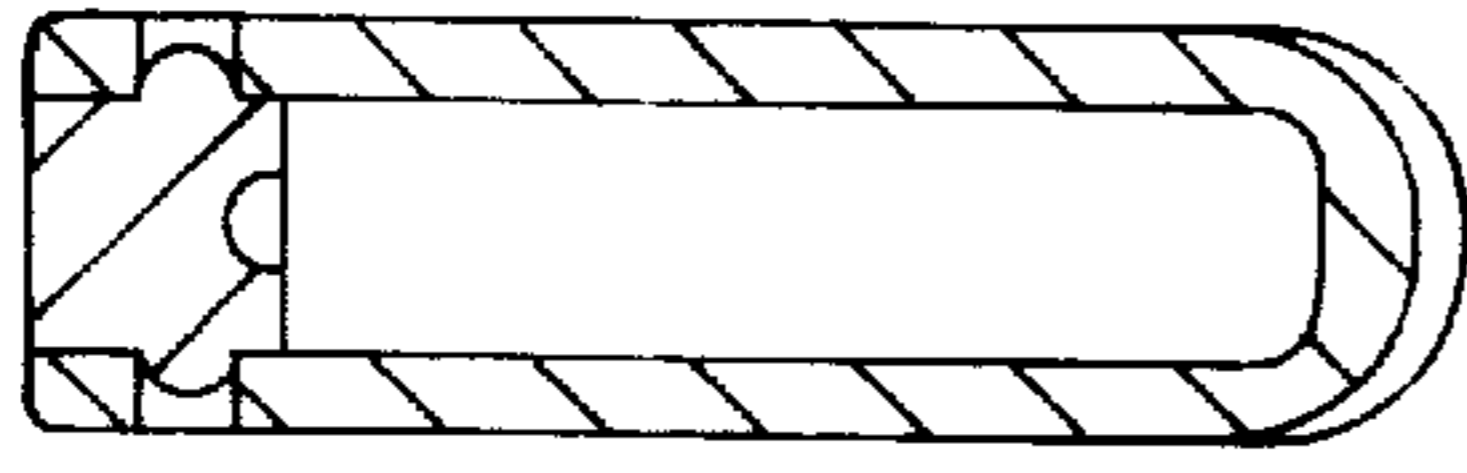

FIG. 14

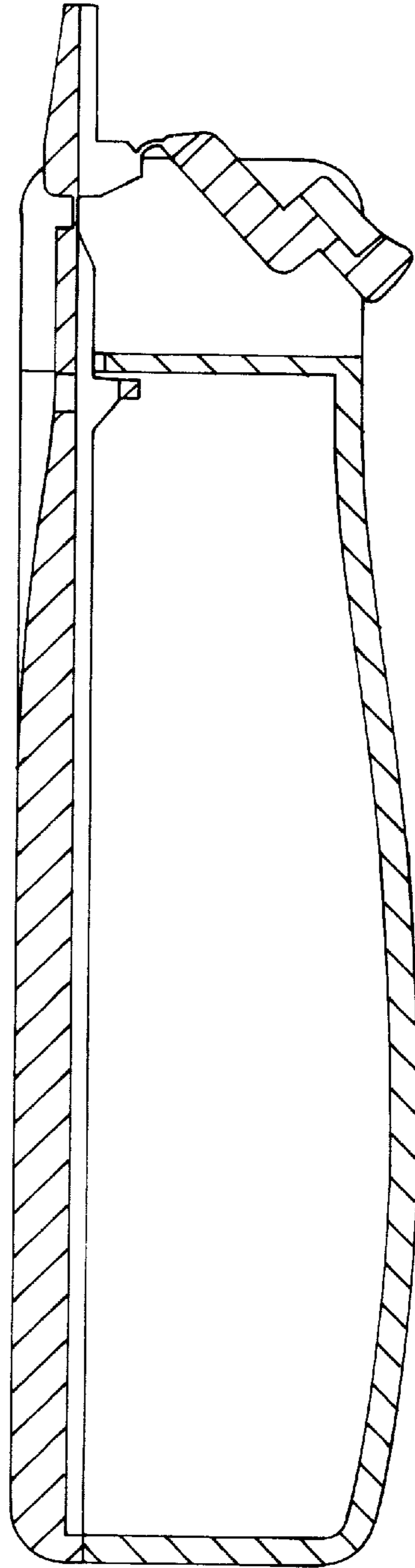

FIG. 13

