



US00D448972B1

(12) **United States Design Patent**  
**Knorr**

(10) **Patent No.:** **US D448,972 S**

(45) **Date of Patent:** **\*\* Oct. 9, 2001**

- (54) **HANDLE FOR KITCHEN WARE**
- (75) Inventor: **Andres Emaranza Knorr**, Vitoria (ES)
- (73) Assignee: **Esmaltaciones San Ignacio, S.A.**,  
Vitoria (ES)
- (\*\*) Term: **14 Years**
- (21) Appl. No.: **29/138,081**
- (22) Filed: **Mar. 7, 2001**

- D. 365,494 12/1995 Roussard .
- D. 366,181 1/1996 Rossiaud .
- D. 384,547 \* 10/1997 Roussard et al. .... D7/358
- D. 392,151 3/1998 Munari .
- D. 410,817 \* 6/1999 Brunianyn ..... D7/393
- D. 417,121 11/1999 Brunianyn .

\* cited by examiner

*Primary Examiner*—Caron D. Veynar  
(74) *Attorney, Agent, or Firm*—Browdy and Neimark

**Related U.S. Application Data**

- (62) Division of application No. 29/116,691, filed on Jan. 6, 2000.

(30) **Foreign Application Priority Data**

Jul. 6, 1999 (ES) ..... 145 894

- (51) **LOC (7) Cl.** ..... **07-02**
- (52) **U.S. Cl.** ..... **D7/393**
- (58) **Field of Search** ..... D7/354–361, 401.2,  
D7/393–395; 16/110.1, 430, 431, 441, 444,  
DIG. 12, DIG. 18, DIG. 19; 220/573.1,  
752, 753

(56) **References Cited**

**U.S. PATENT DOCUMENTS**

D. 328,997 9/1992 Gerlach .

(57) **CLAIM**

The ornamental design for a handle for kitchen ware, as shown and described.

**DESCRIPTION**

FIG. 1 is a perspective view of a handle for kitchen ware in accordance with the present design;  
 FIG. 2 is a bottom plan thereof;  
 FIG. 3 is a side elevational view thereof, the opposite side being a mirror image thereof;  
 FIG. 4 is an end view thereof;  
 FIG. 5 is an opposite end view thereof; and,  
 FIG. 6 is a top plan thereof.

**1 Claim, 2 Drawing Sheets**

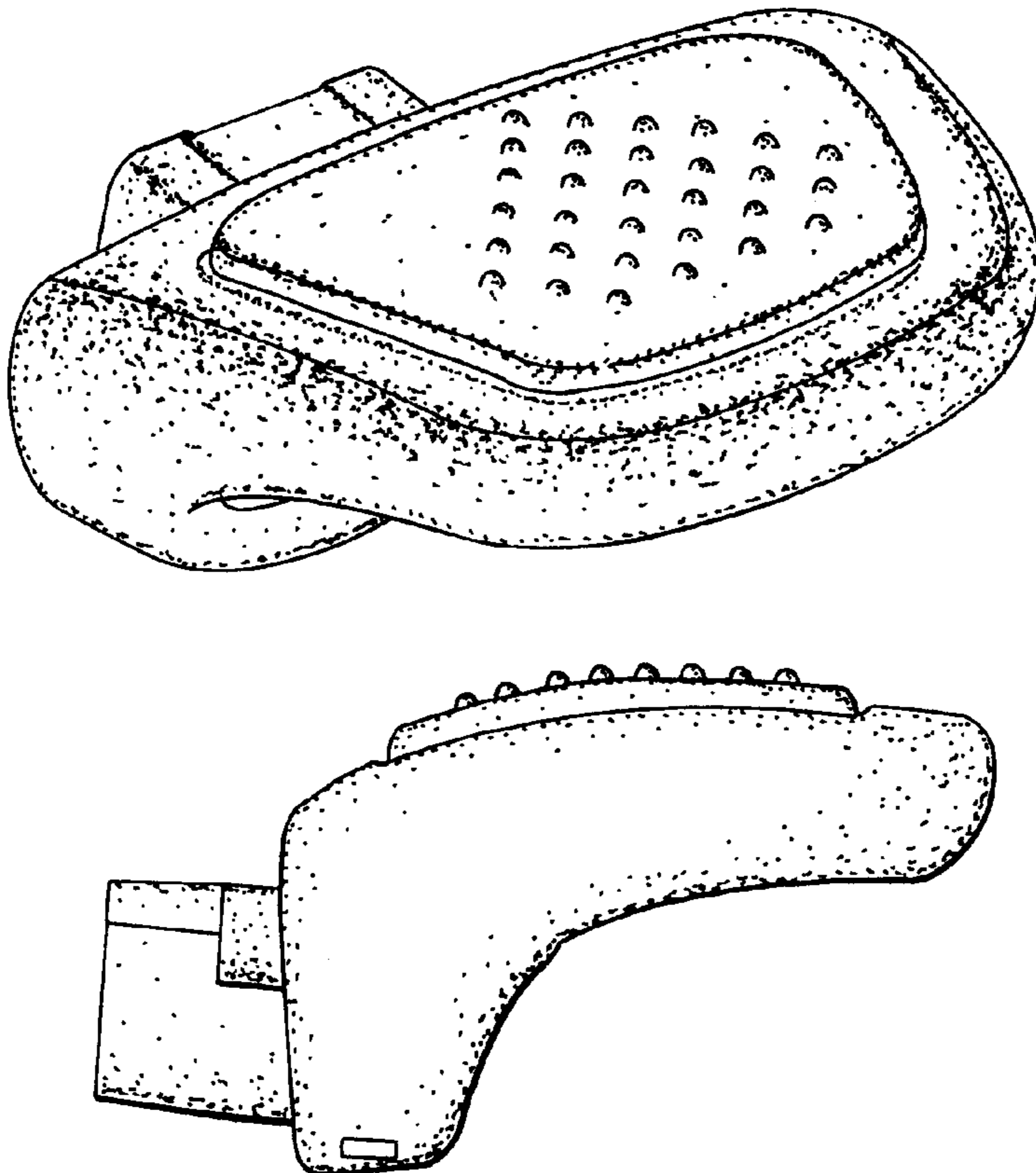

*FIG. 1*

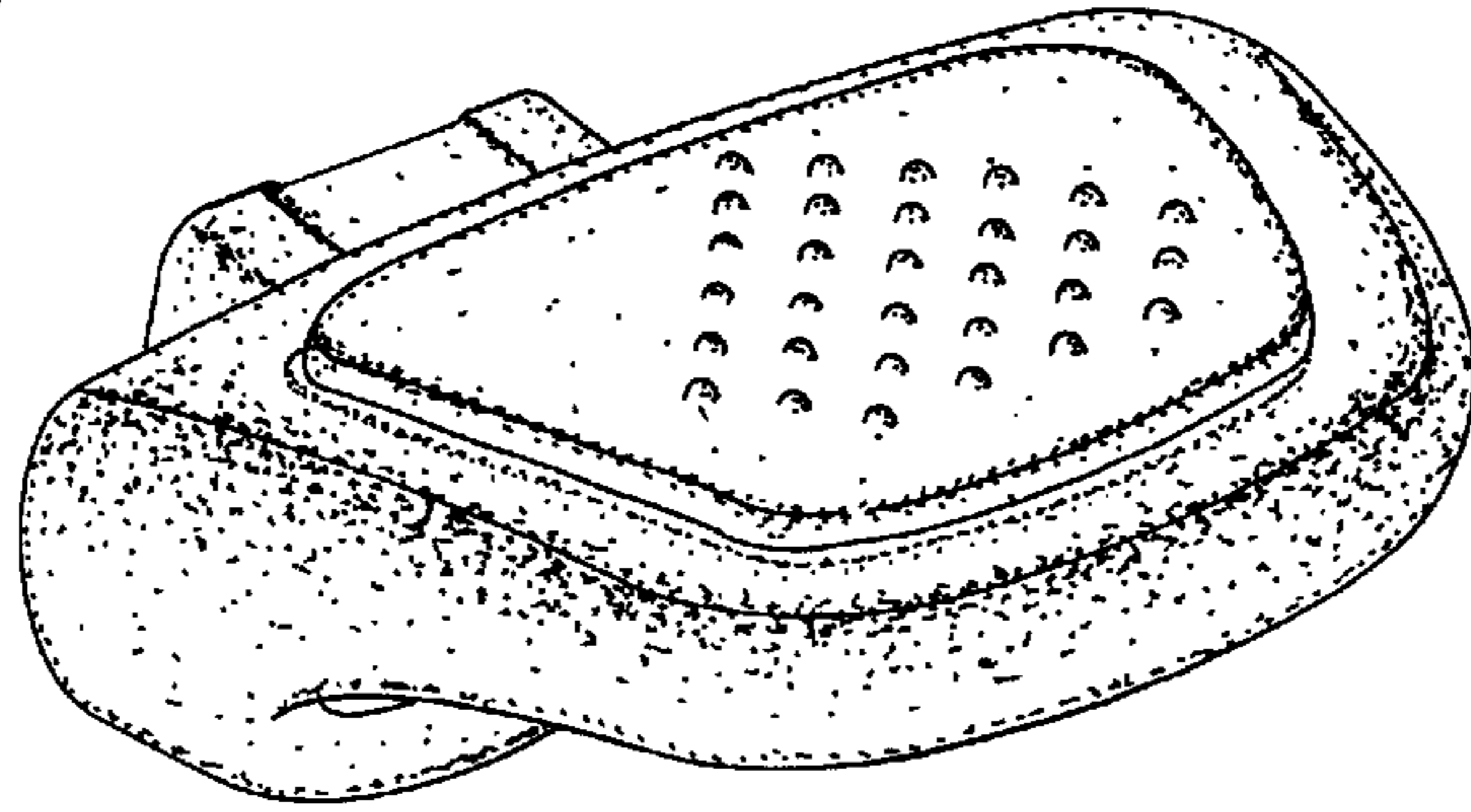

*FIG. 2*

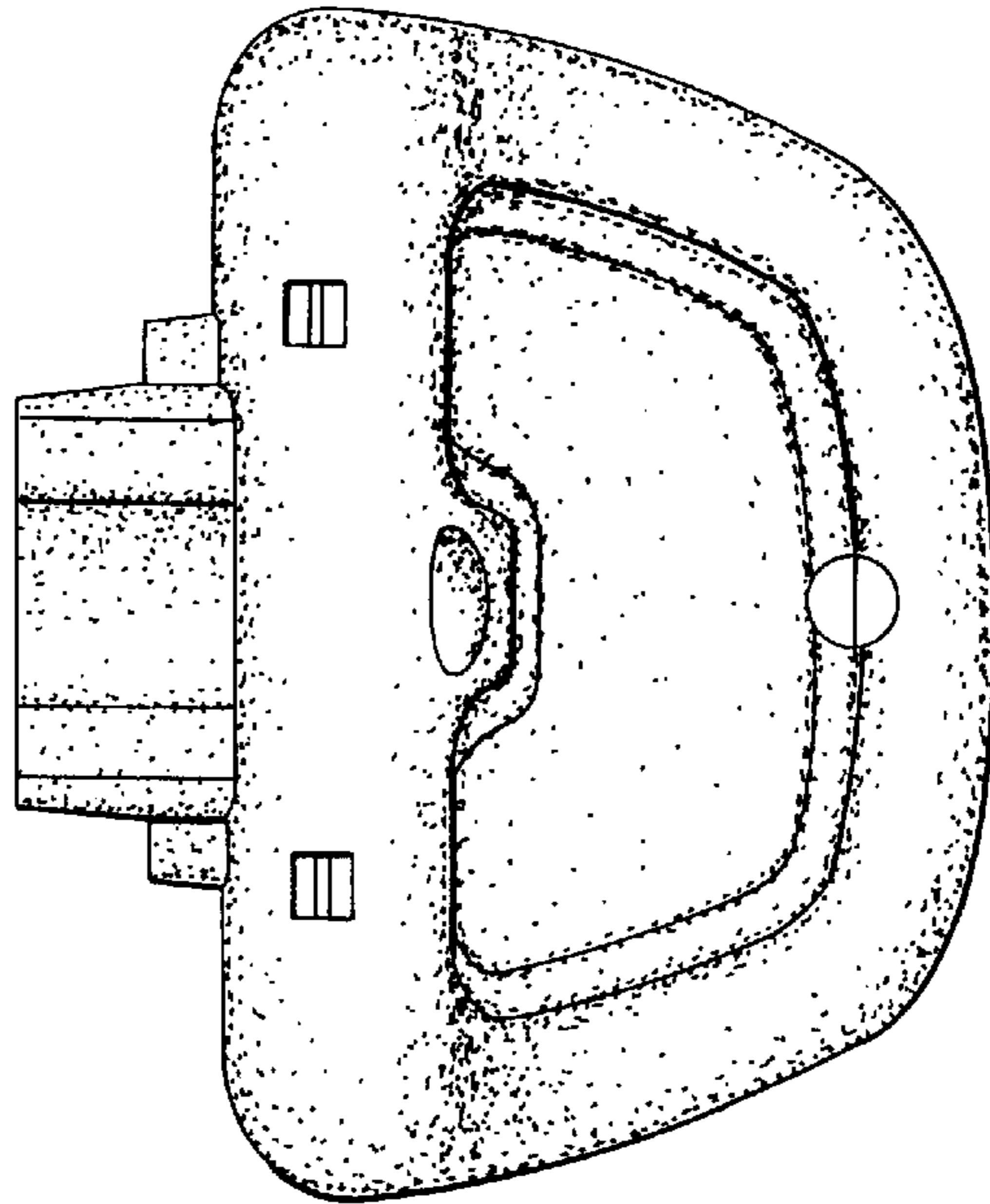

*FIG. 3*

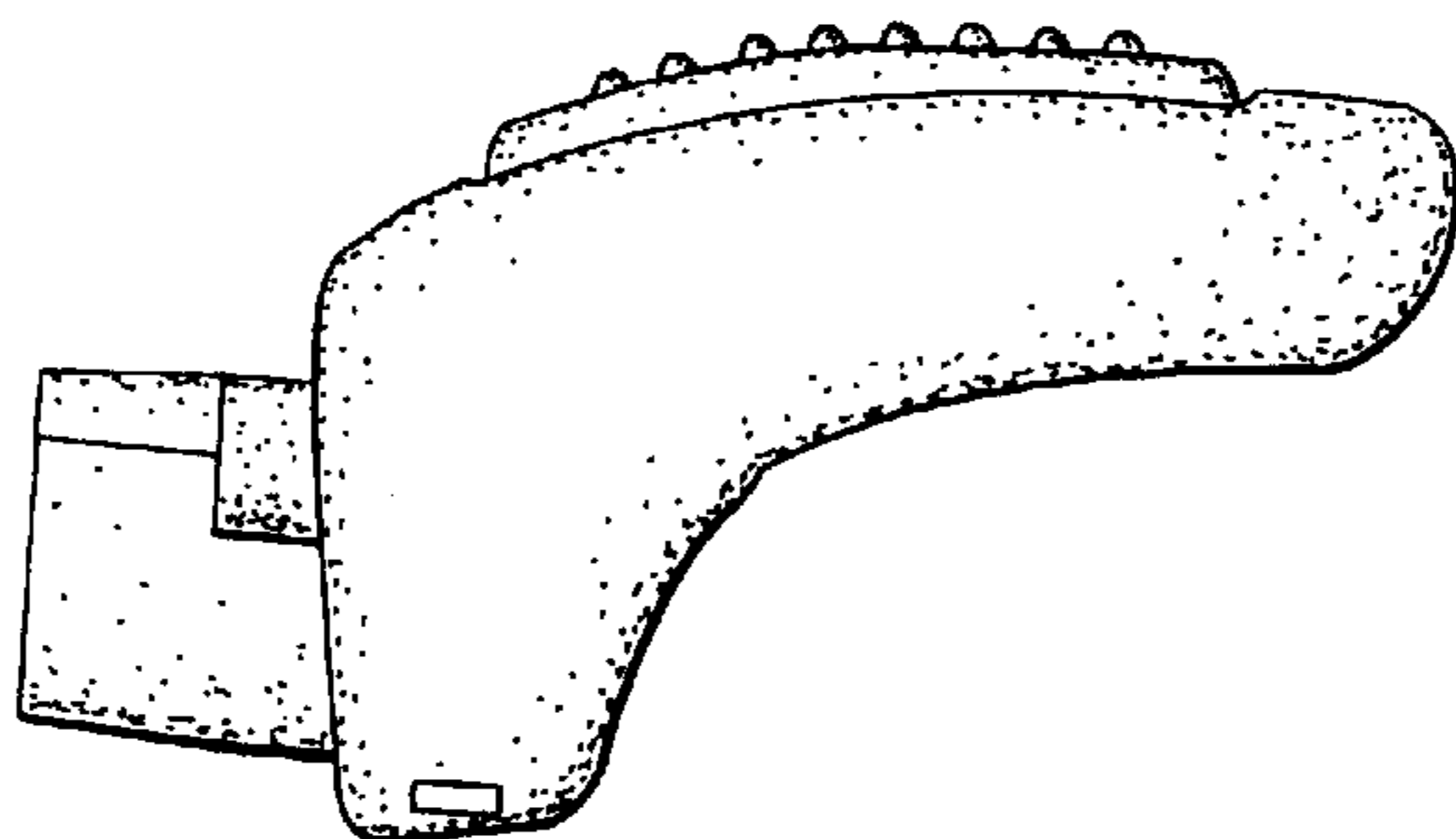

*FIG. 4*

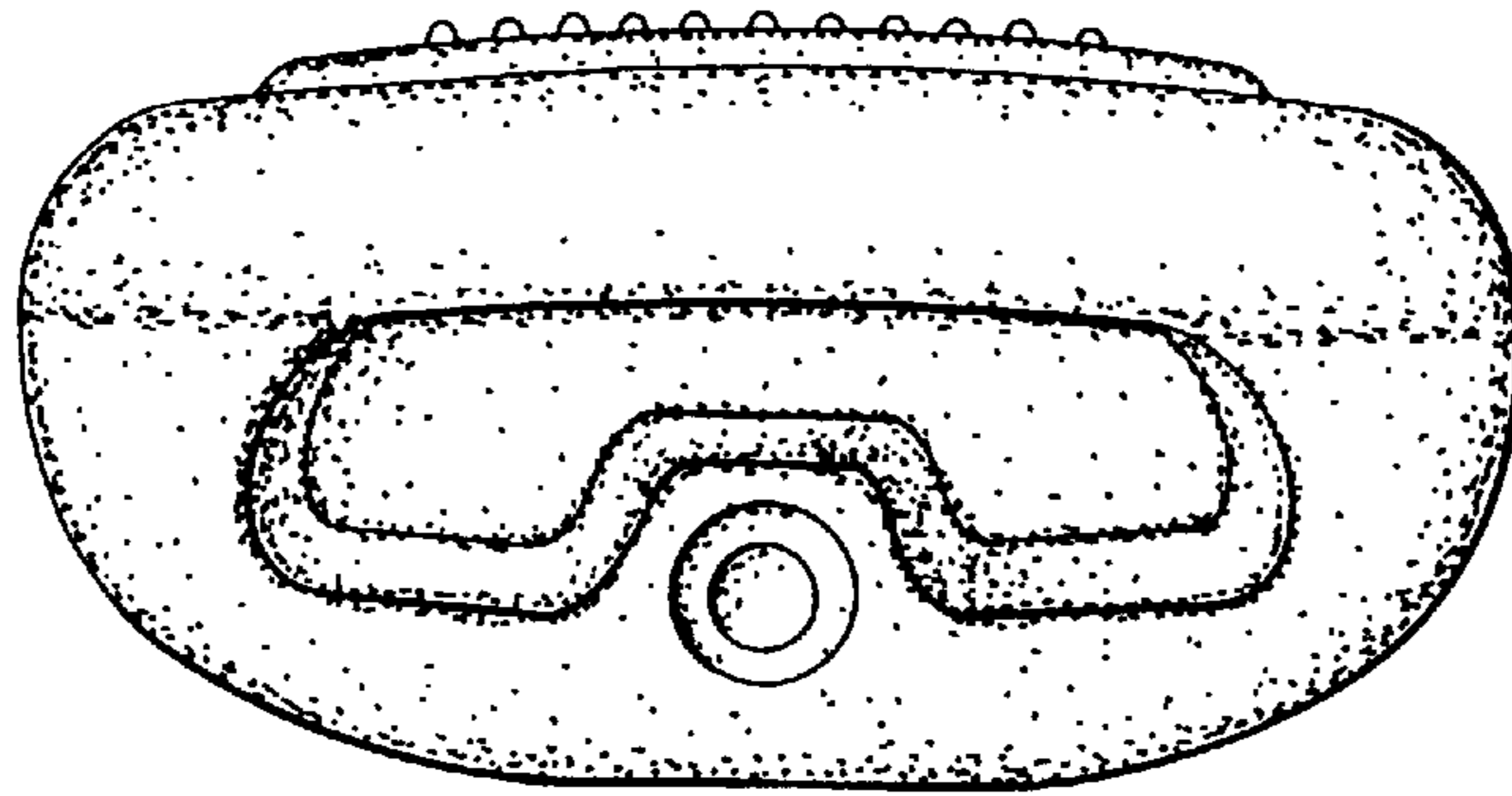

*FIG. 5*

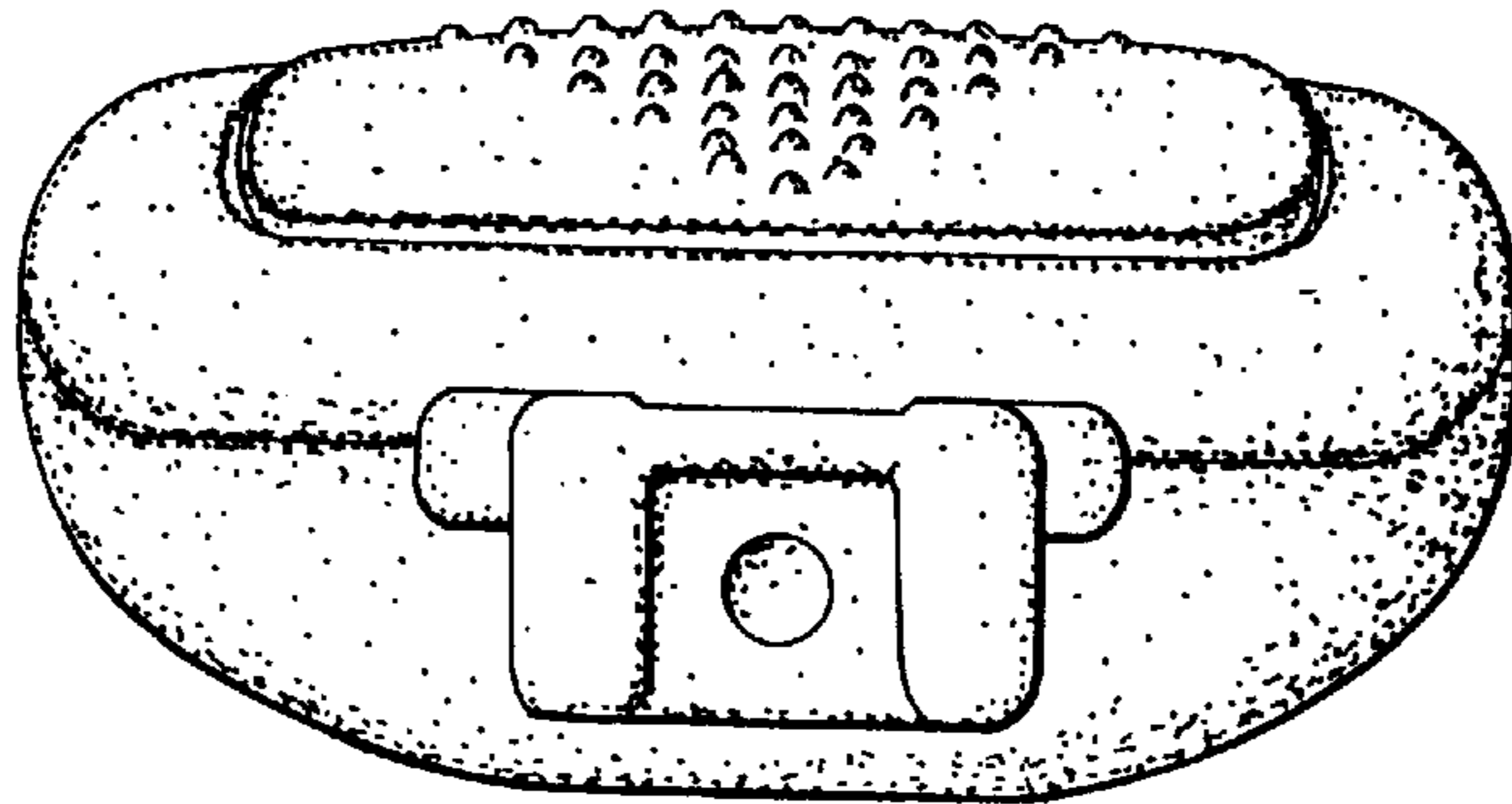

*FIG. 6*

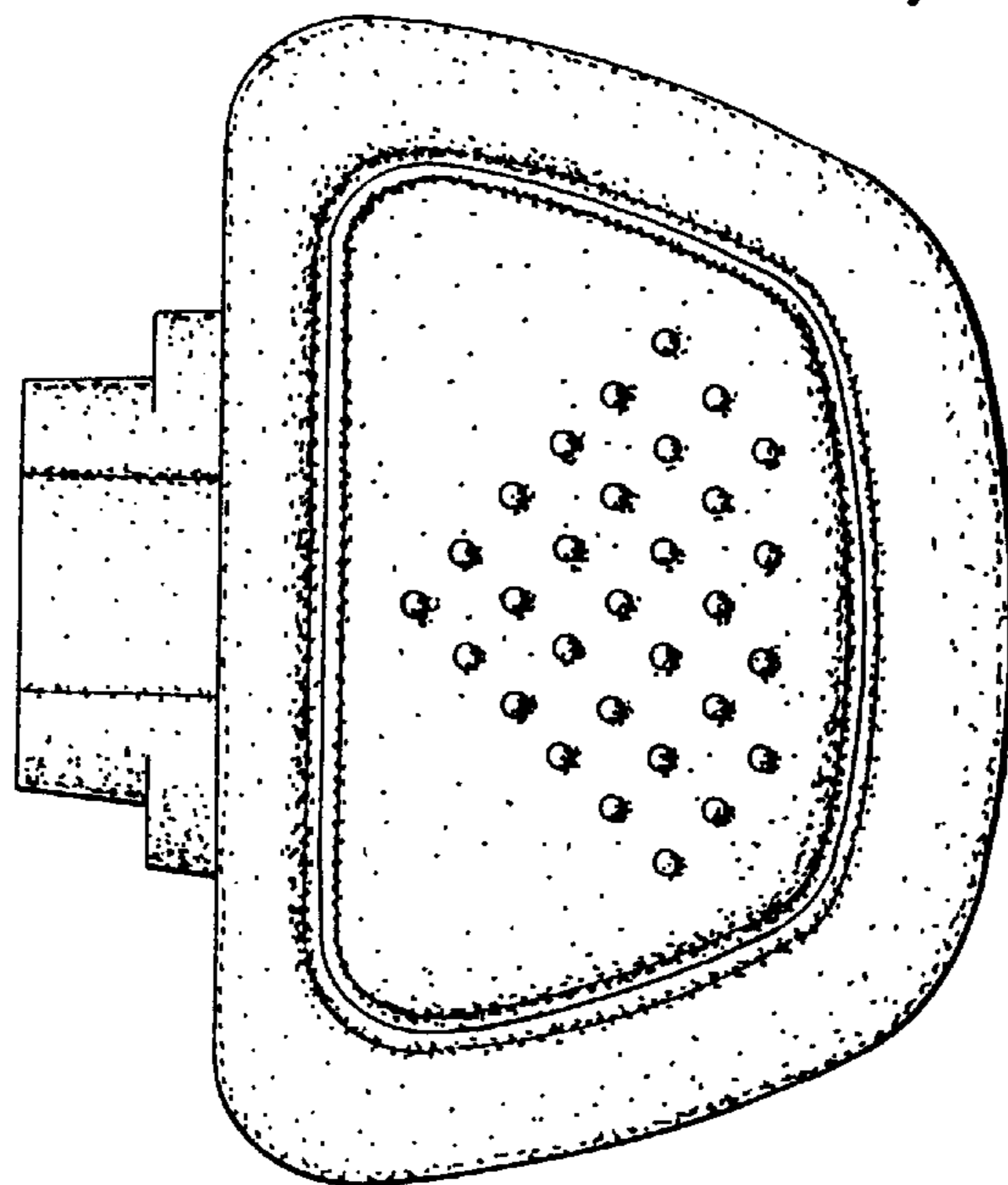

UNITED STATES PATENT AND TRADEMARK OFFICE  
**CERTIFICATE OF CORRECTION**

PATENT NO. : Des 448,972 S  
DATED : October 9, 2001  
INVENTOR(S) : Andres Emparanza Knorr

Page 1 of 1

It is certified that error appears in the above-identified patent and that said Letters Patent is hereby corrected as shown below:

Title page,

Item [75], delete "Emaranza" and insert therefor -- Emparanza --.

Signed and Sealed this

Twenty-sixth Day of February, 2002

*Attest:*

A handwritten signature in black ink, appearing to read "James E. Rogan", written over a horizontal line.

*Attesting Officer*

JAMES E. ROGAN  
*Director of the United States Patent and Trademark Office*