



US00D448930B1

(12) **United States Design Patent**
Kambouris

(10) **Patent No.:** **US D448,930 S**

(45) **Date of Patent:** **** Oct. 9, 2001**

(54) **PERSONAL ORGANIZER CASE**

(75) Inventor: **Thomas C. Kambouris**, Jackson, WY (US)

(73) Assignee: **Rhinoskin, Inc.**, Jackson, WY (US)

(**) Term: **14 Years**

(21) Appl. No.: **29/133,369**

(22) Filed: **Nov. 28, 2000**

(51) **LOC (7) Cl.** **03-01**

(52) **U.S. Cl.** **D3/273; D3/294**

(58) **Field of Search** **D3/273, 294, 295, D3/303, 282; D19/26, 75; D9/420; 206/425, 215**

(56) **References Cited**

U.S. PATENT DOCUMENTS

D. 291,558	*	8/1987	Fonville	D3/272
D. 294,774	*	3/1988	Kitada	D3/273
D. 302,357	*	7/1989	Fontaine, Jr.	D3/272
D. 310,099	*	8/1990	Chapman et al.	D3/273
D. 346,403	*	4/1994	Ros	D3/282
D. 346,404	*	4/1994	Ros	D3/282
D. 352,525	*	11/1994	Coe	D9/420
D. 369,829	*	5/1996	Tomita et al.	D9/420

* cited by examiner

Primary Examiner—Philip S. Hyder

(74) *Attorney, Agent, or Firm*—Michael S. Neustel

(57) **CLAIM**

The ornamental design for a personal organizer case, as shown in the above figures and described.

DESCRIPTION

FIG. 1 is a front view of a personal organizer case showing my new design;
 FIG. 2 is a rear view of the personal organizer case showing my new design;
 FIG. 3 is a bottom end view of the personal organizer case showing my new design;
 FIG. 4 is a top end view of the personal organizer case showing my new design;
 FIG. 5 is a right side view of the personal organizer case showing my new design;
 FIG. 6 is a left side view of the personal organizer case showing my new design;
 FIG. 7 is a front view of the personal organizer case in the open position showing my new design;
 FIG. 8 is a rear view of the personal organizer case in the open position showing my new design;
 FIG. 9 is a bottom end view of the personal organizer case in the open position showing my new design;
 FIG. 10 is a top end view of the personal organizer case in the open position showing my new design;
 FIG. 11 is a right side view of a front portion of the personal organizer case; and
 FIG. 12 is a right side view of a rear portion of the personal organizer case; and,
 FIG. 13 is a perspective view of the personal organizer case.

1 Claim, 7 Drawing Sheets



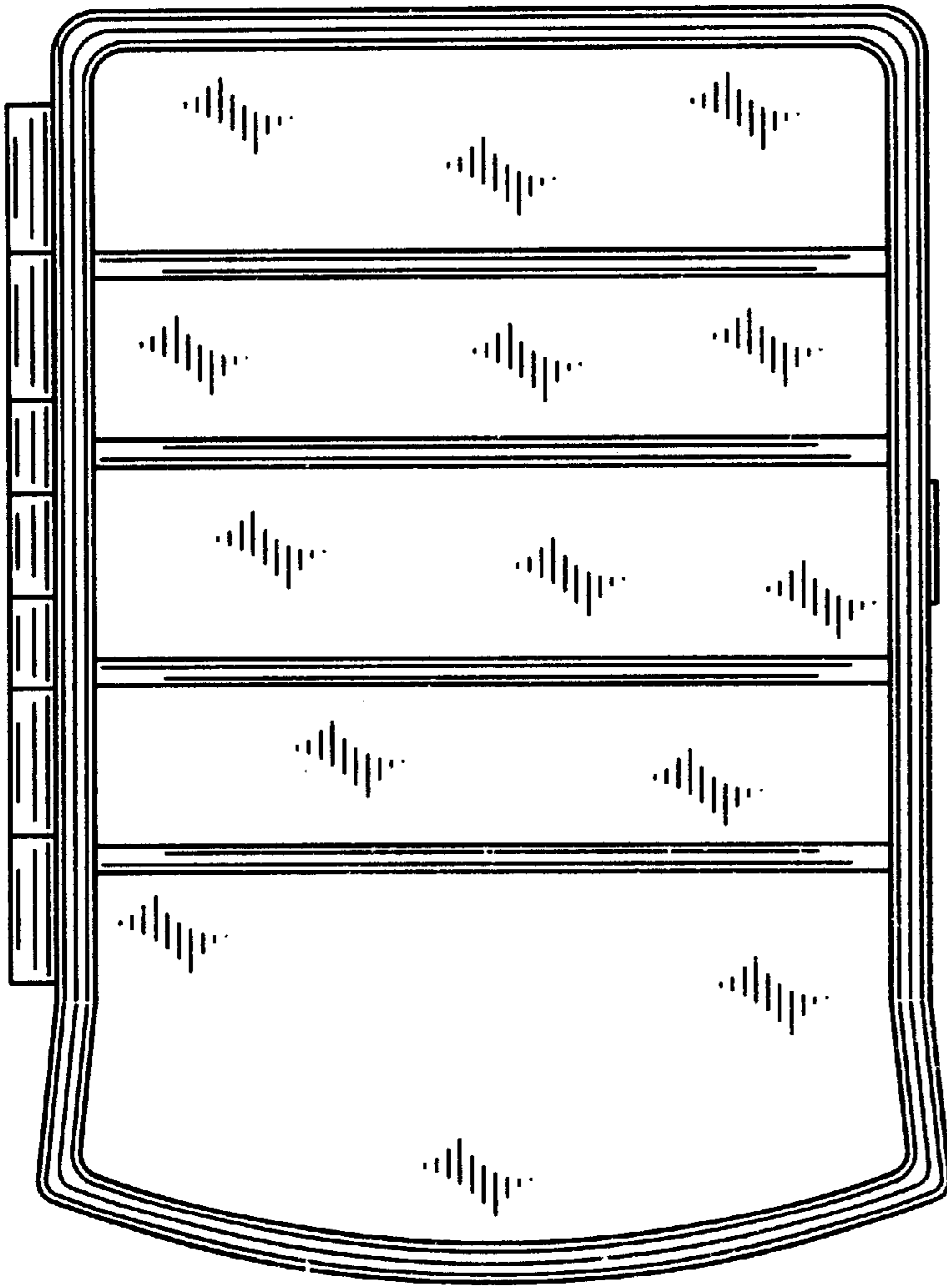

FIG. 1



FIG. 3

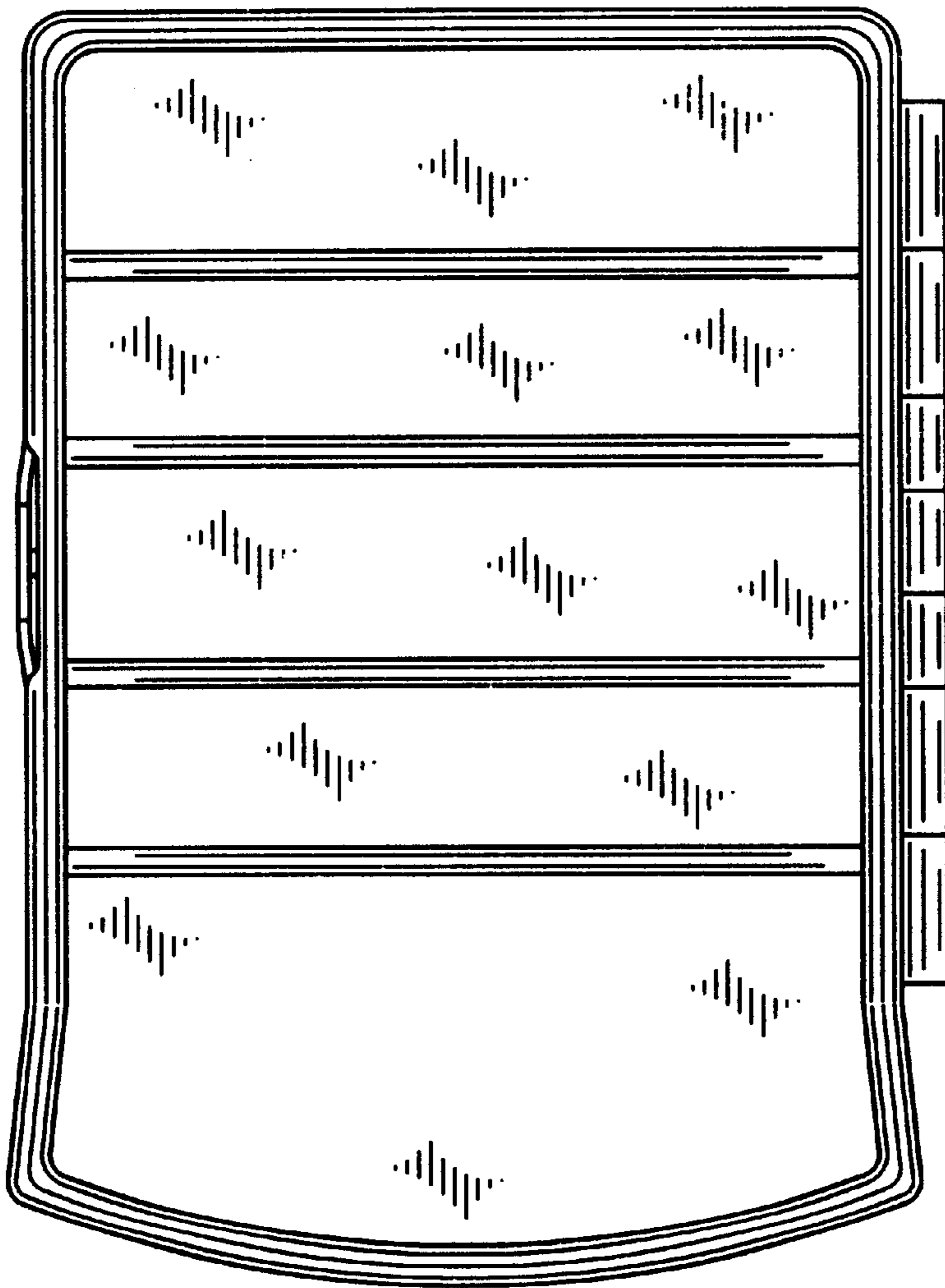

FIG. 2

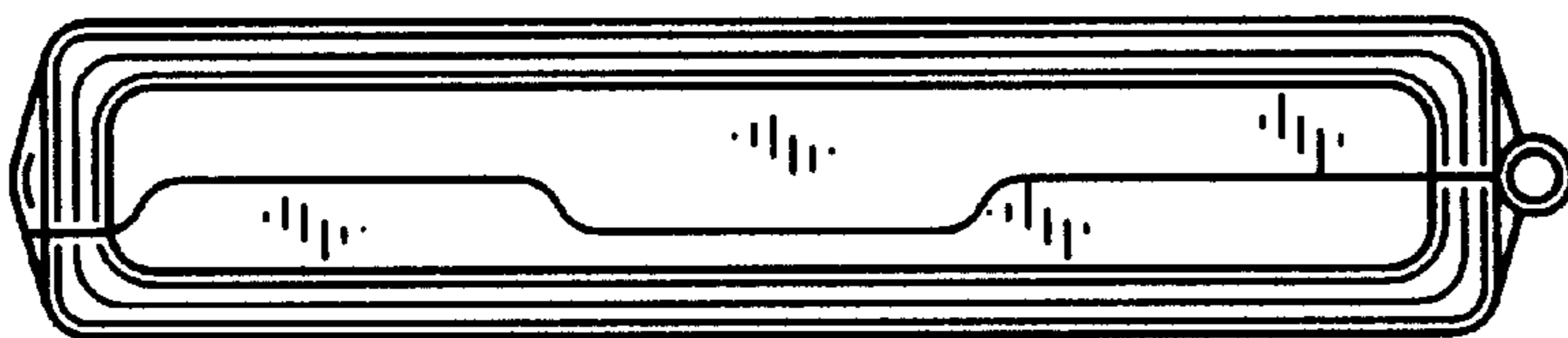

FIG. 4

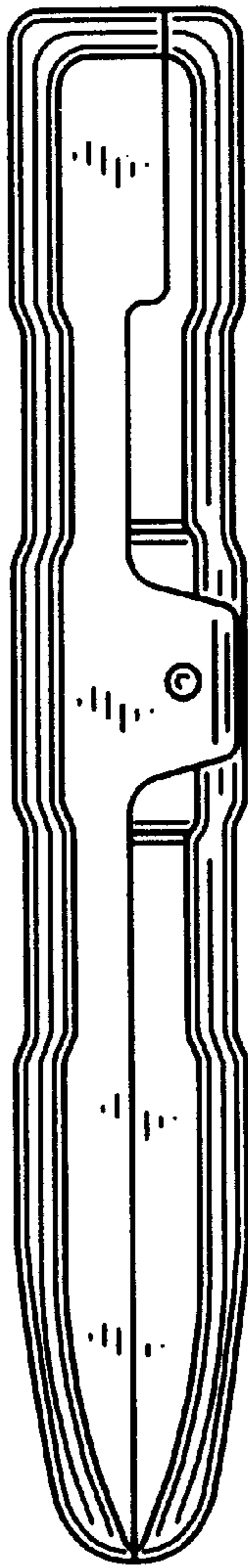

FIG. 5

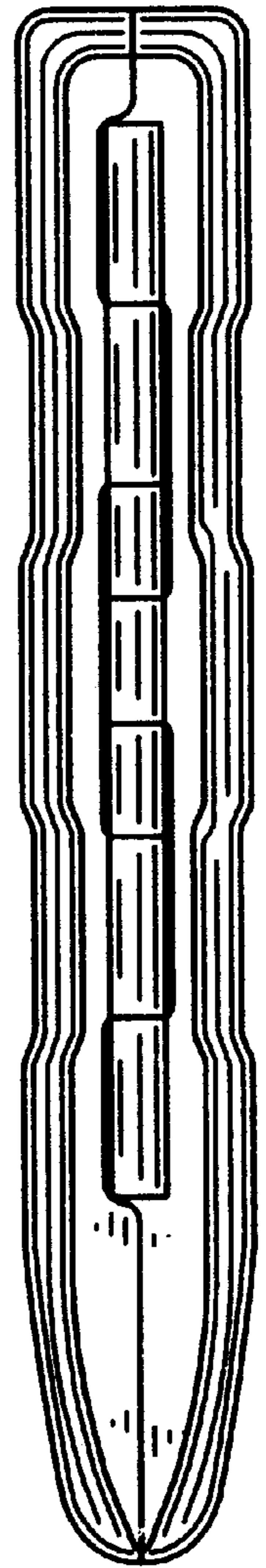

FIG. 6

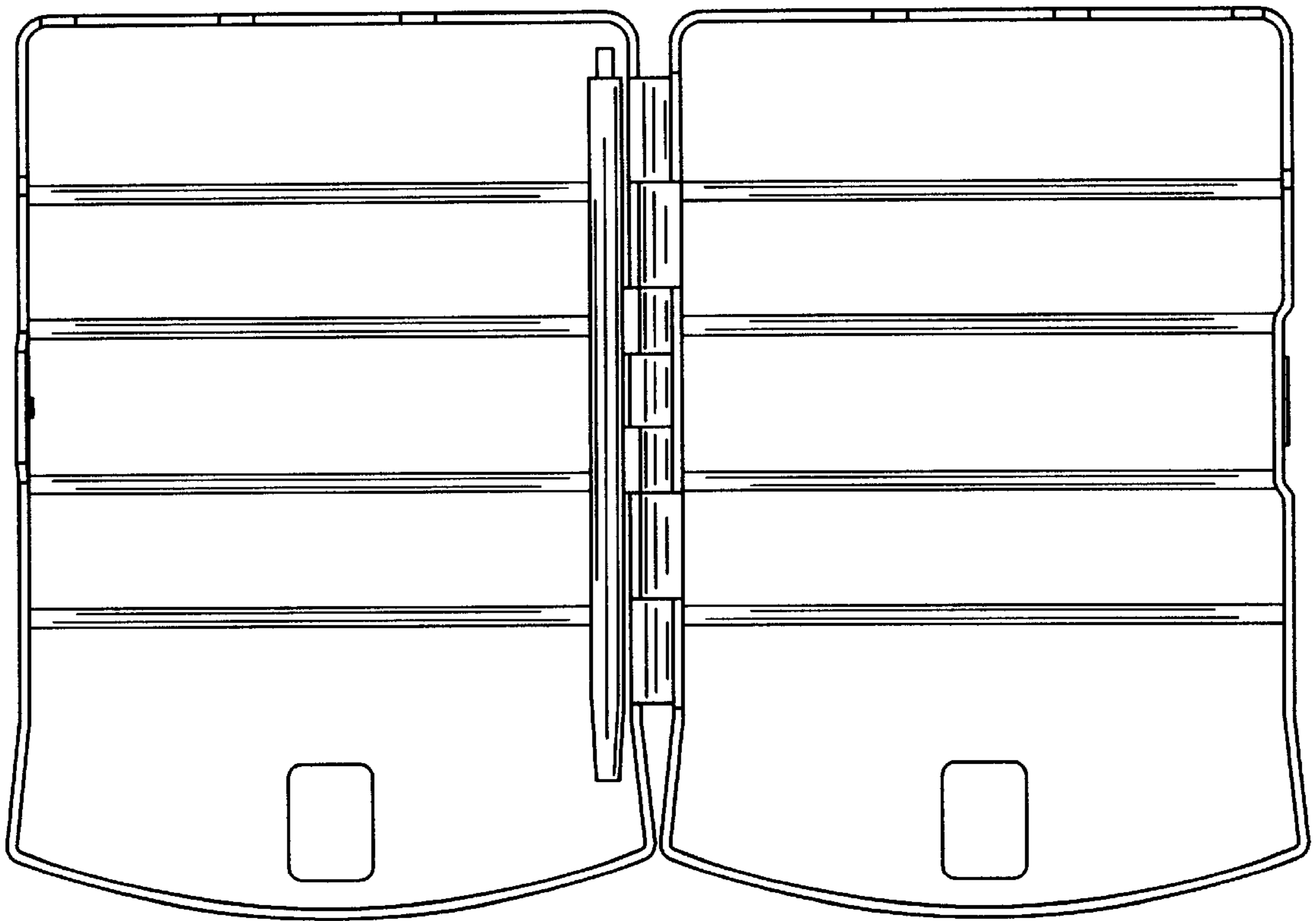

FIG. 7

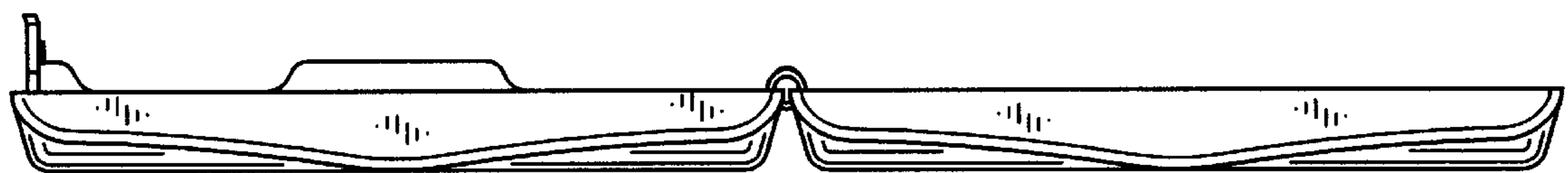

FIG. 9

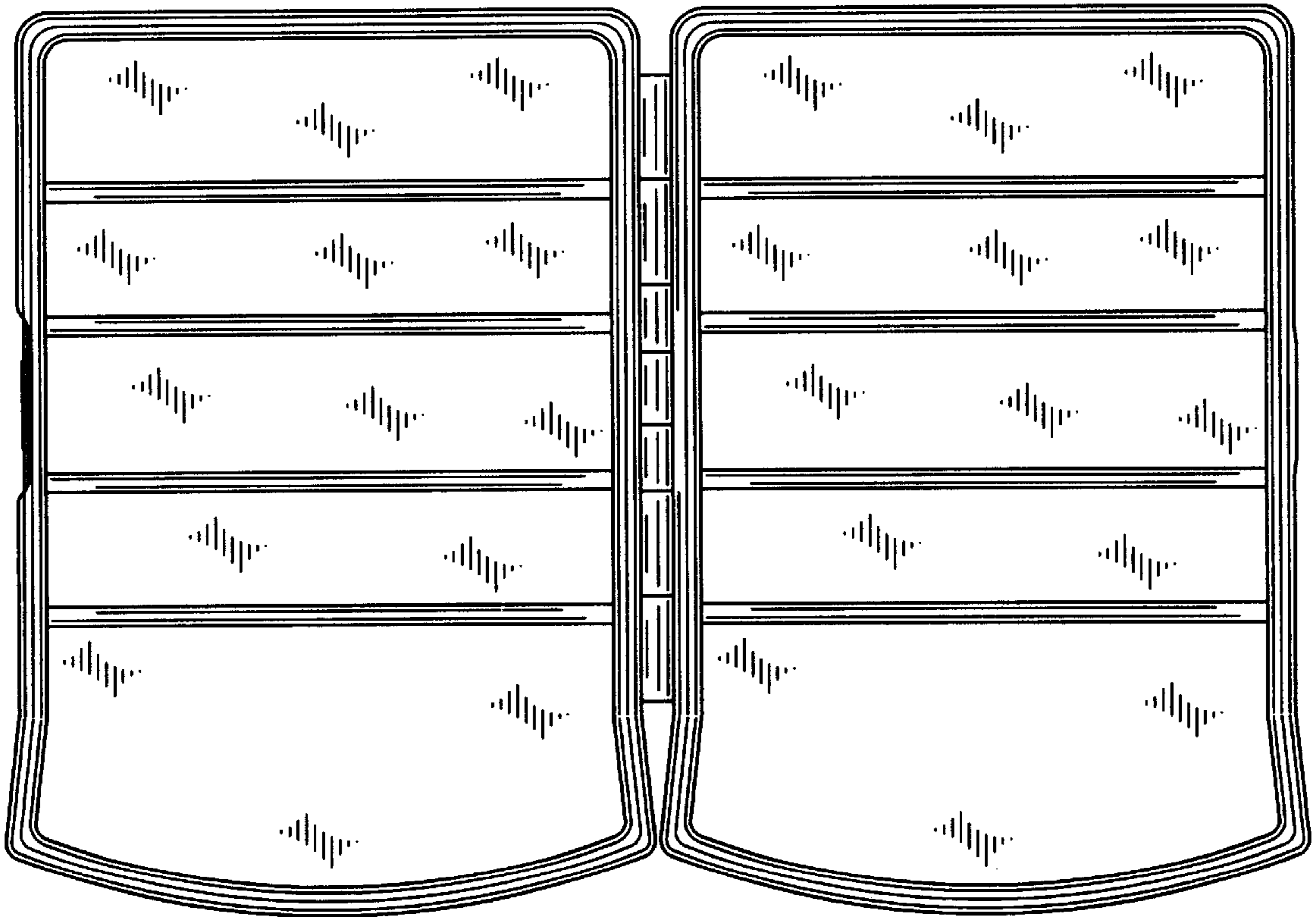

FIG. 8

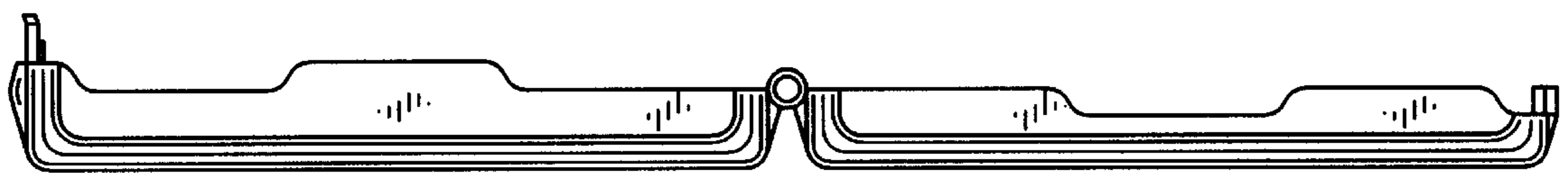

FIG. 10

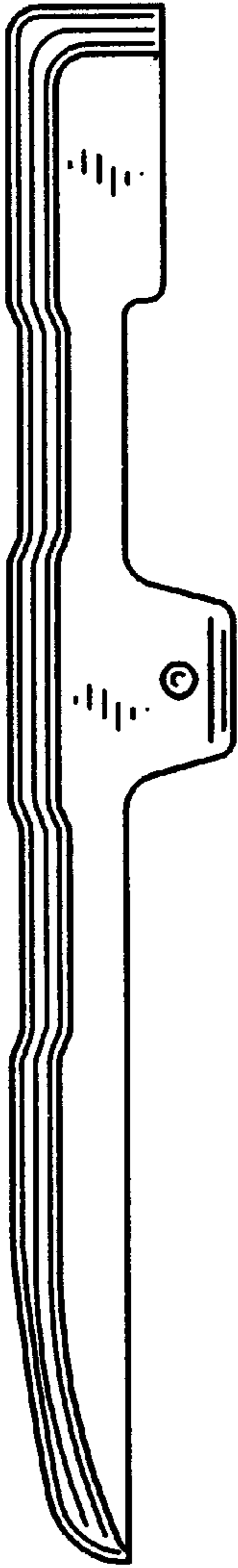

FIG. 11

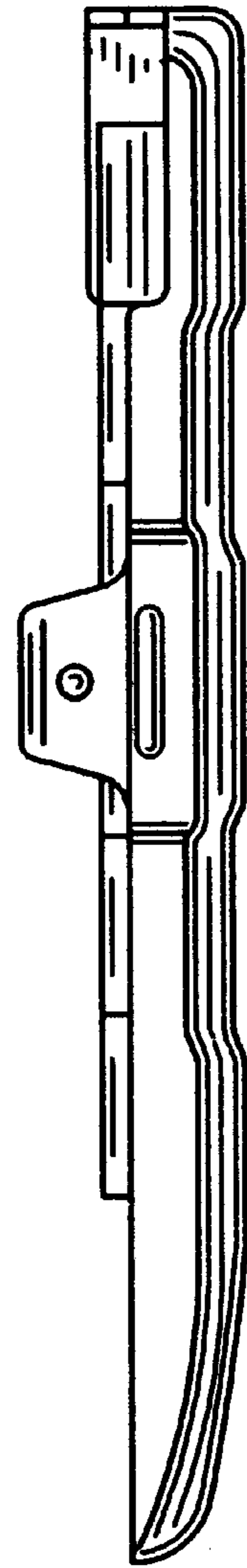

FIG. 12

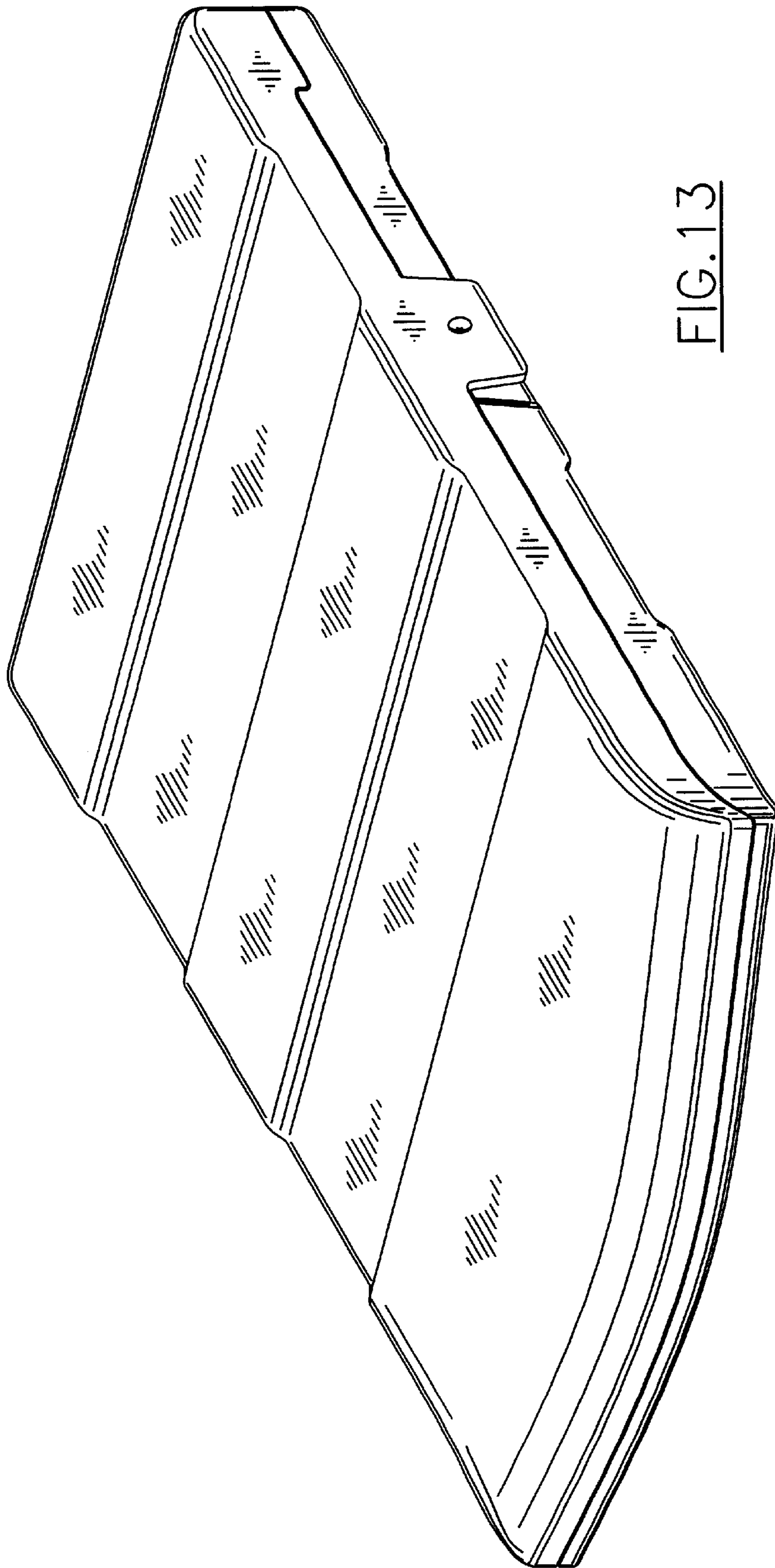

FIG. 13