



US00D44888B1

(12) **United States Design Patent**  
**Focke et al.**

(10) **Patent No.:** **US D448,888 S**

(45) **Date of Patent:** **\*\* Oct. 2, 2001**

- (54) **CIGARETTE PACK**
- (75) Inventors: **Heinz Focke**, Verden; **Henry Buse**, Visselhövede, both of (DE)
- (73) Assignee: **Focke & Co (GmbH & Co.)**, Verden (DE)
- (\*\*) Term: **14 Years**
- (21) Appl. No.: **29/136,859**
- (22) Filed: **Feb. 8, 2001**

5,487,468	*	1/1996	Sheahan	.....	206/242
5,715,936	*	2/1998	Focke et al.	.....	206/268
5,823,331	*	10/1998	Manservigi	.....	206/268
5,845,770	*	12/1998	James et al.	.....	206/268
5,896,984	*	4/1999	Focke et al.	.....	206/268
5,921,384	*	7/1999	Focke et al.	.....	206/268

\* cited by examiner

*Primary Examiner*—Alan P. Douglas

*Assistant Examiner*—Jennifer Rivard

(74) *Attorney, Agent, or Firm*—Abelman, Frayne & Schwab

**Related U.S. Application Data**

- (62) Division of application No. 29/106,212, filed on Jun. 9, 1999, now Pat. No. Des. 441,496.

(30) **Foreign Application Priority Data**

Dec. 10, 1998	(DE)	.....	198 57 118
Dec. 18, 1998	(DE)	.....	198 58 786
Jan. 4, 1999	(XH)	.....	DMA/004 385

- (51) **LOC (7) Cl.** ..... **27-06**
- (52) **U.S. Cl.** ..... **D27/189**
- (58) **Field of Search** ..... D27/172, 183, D27/186, 189; 206/242, 259, 265, 268, 271, 273

(56) **References Cited**

**U.S. PATENT DOCUMENTS**

- D. 421,151 \* 2/2000 Luton et al. .... D27/189

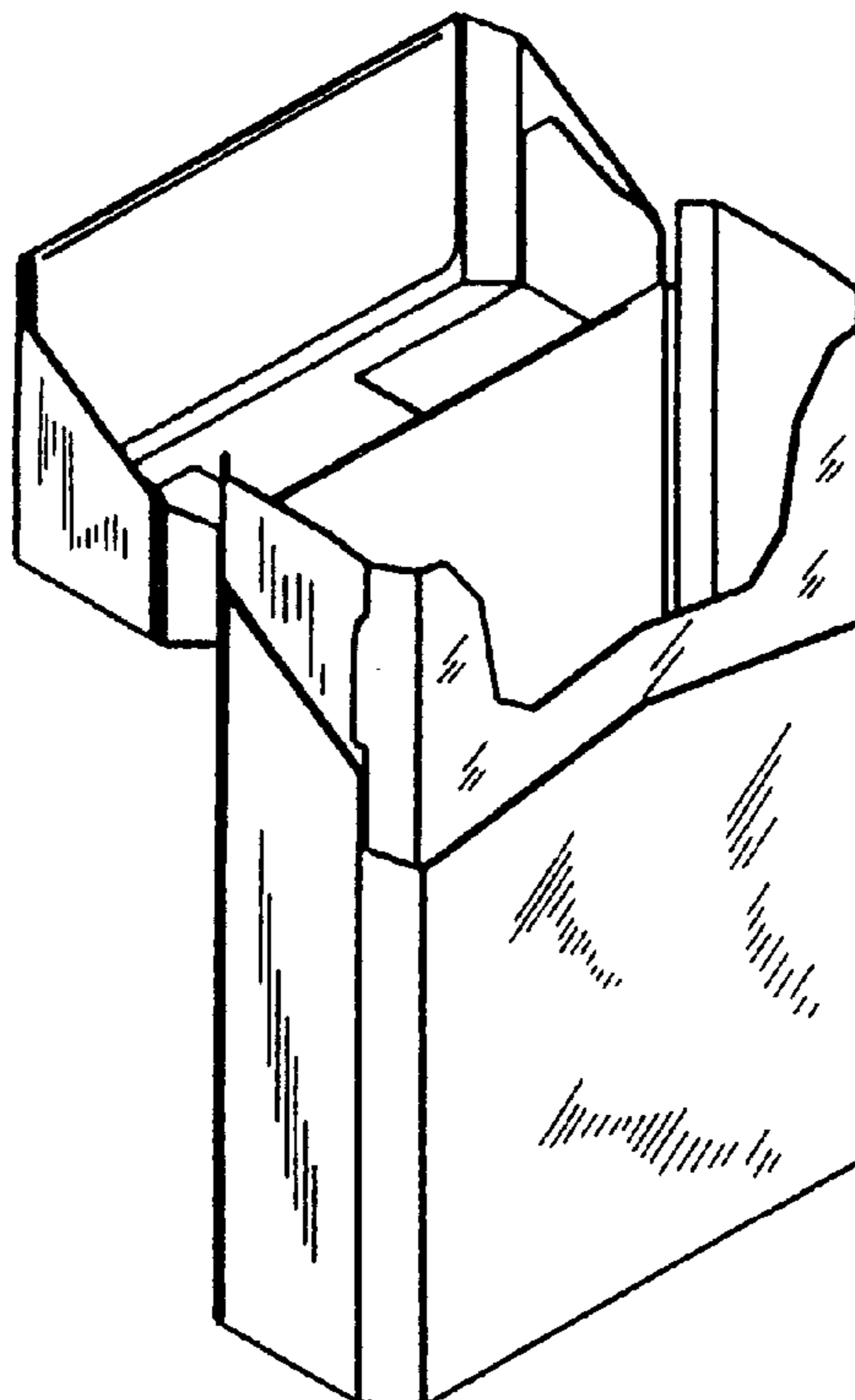
(57) **CLAIM**

The ornamental design for a cigarette pack, as shown and described.

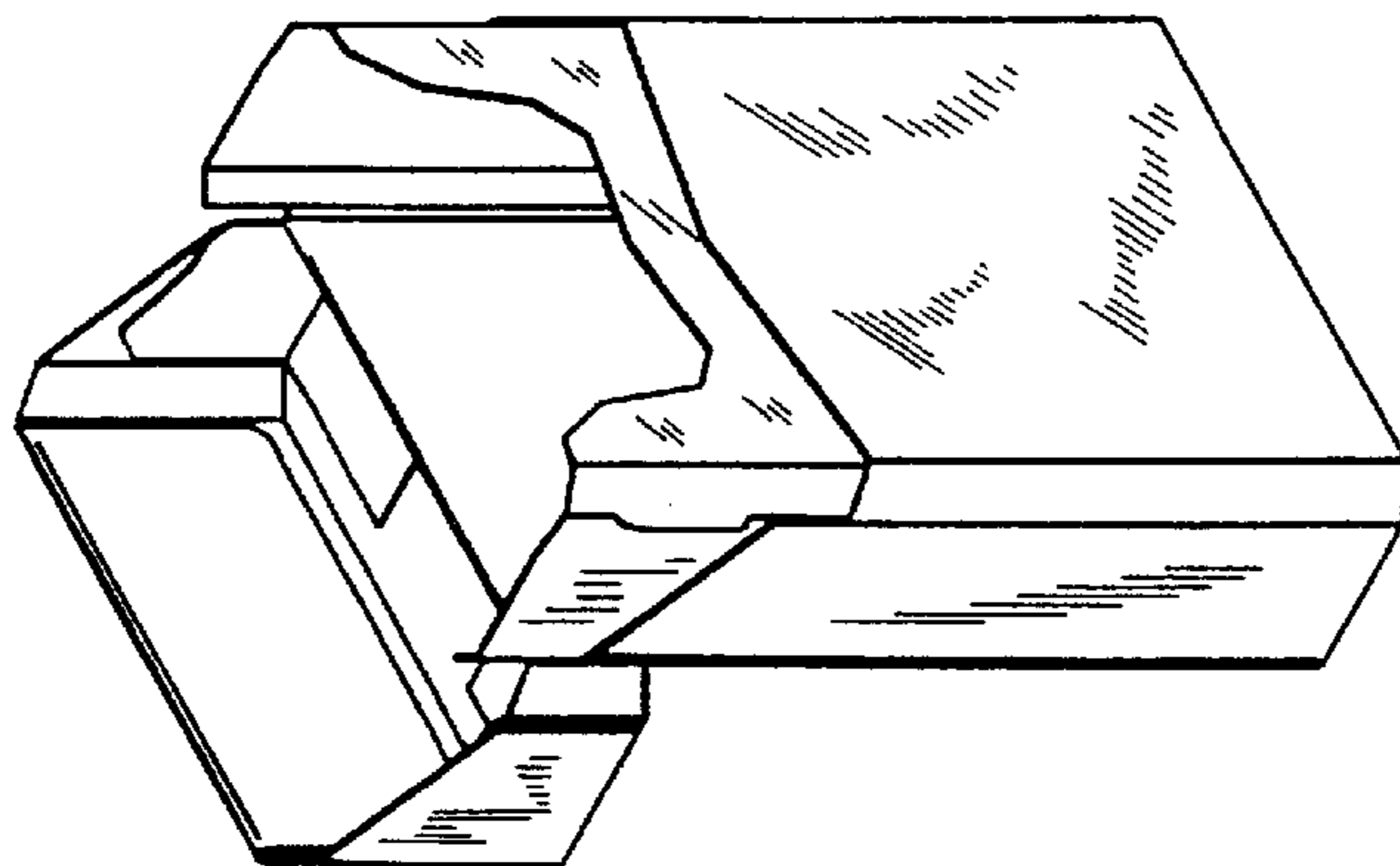
**DESCRIPTION**

FIG. 1 is a perspective view of the first embodiment of our design, with the lid shown open.  
 FIG. 2 is a right-side view thereof, with the lid closed.  
 FIG. 3 is a front view thereof, with the lid closed.  
 FIG. 4 is a left-side view thereof, with the lid closed.  
 FIG. 5 is a bottom view thereof, with the top view corresponding.  
 FIG. 6 is a rear view thereof, with the lid closed.  
 FIG. 7 is a front view of the second embodiment, with the lid closed; and,  
 FIG. 8 is a front view of the third embodiment, with the lid closed.

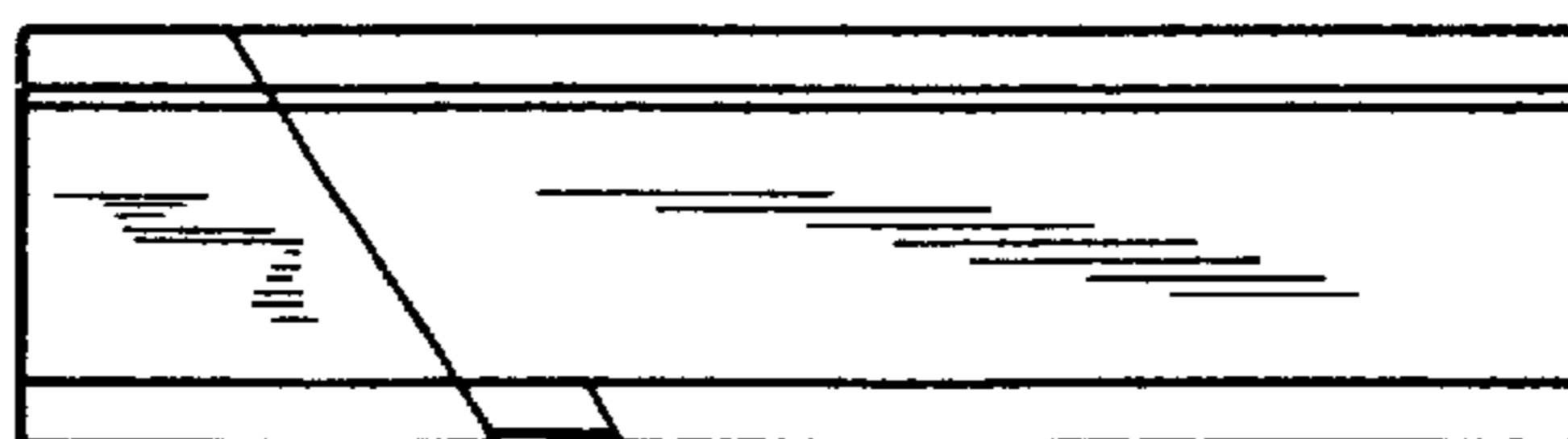
**1 Claim, 2 Drawing Sheets**



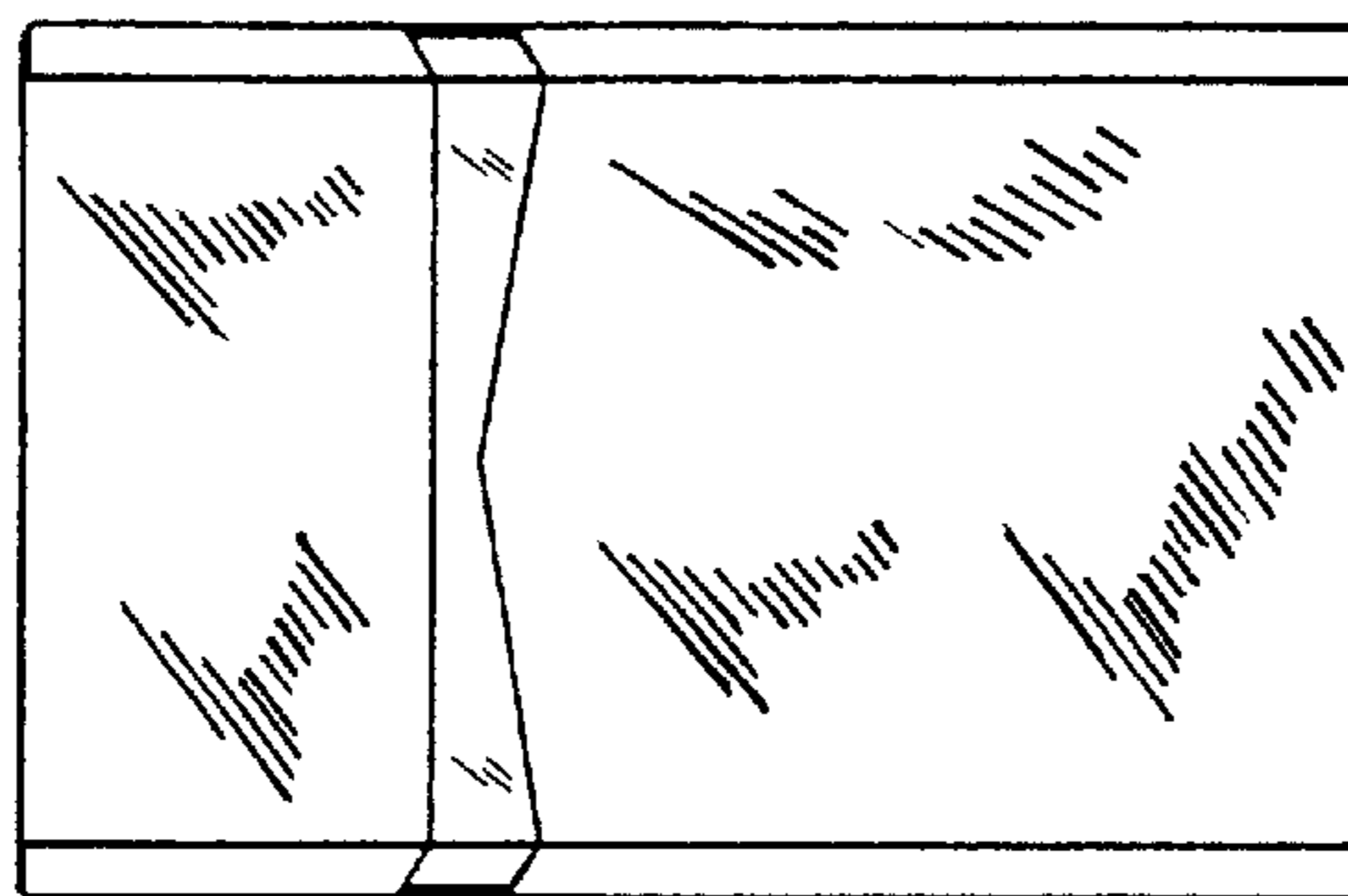
*FIG. 1*



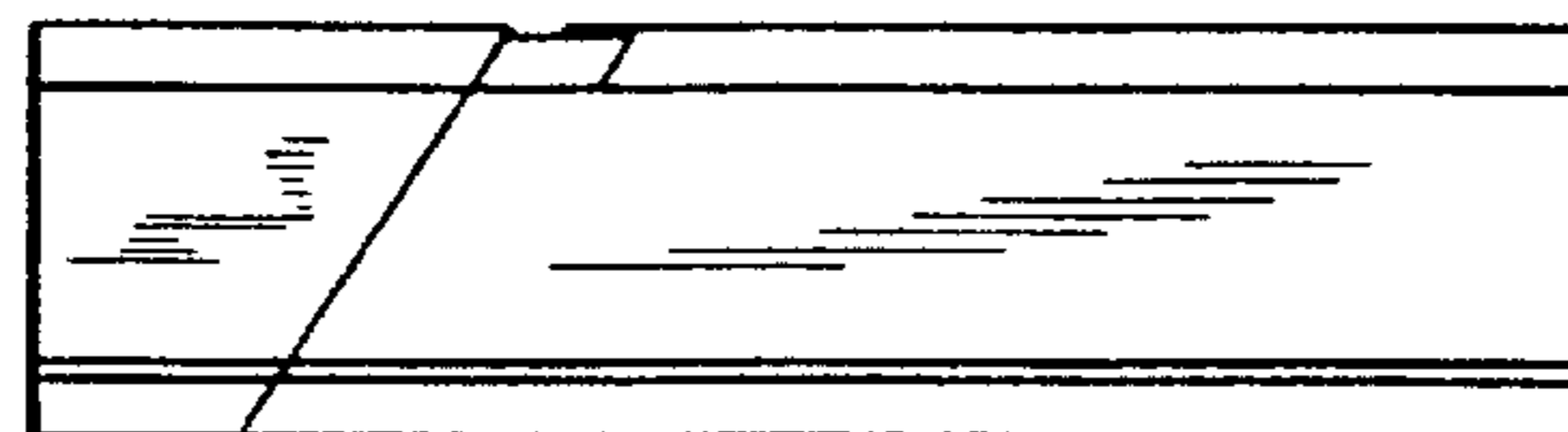
*FIG. 2*



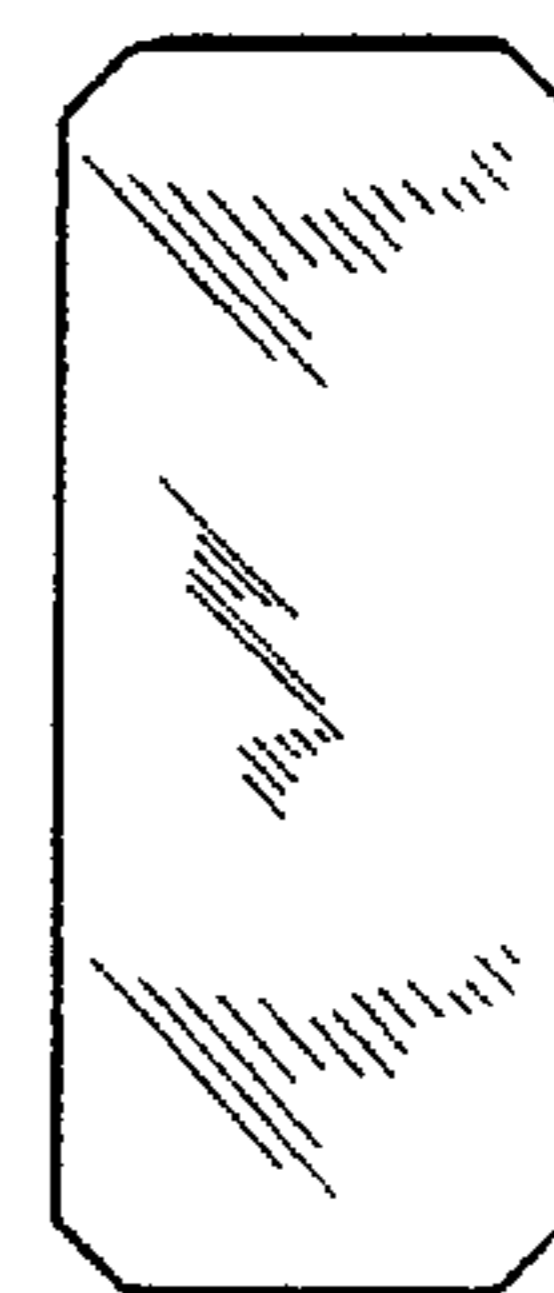
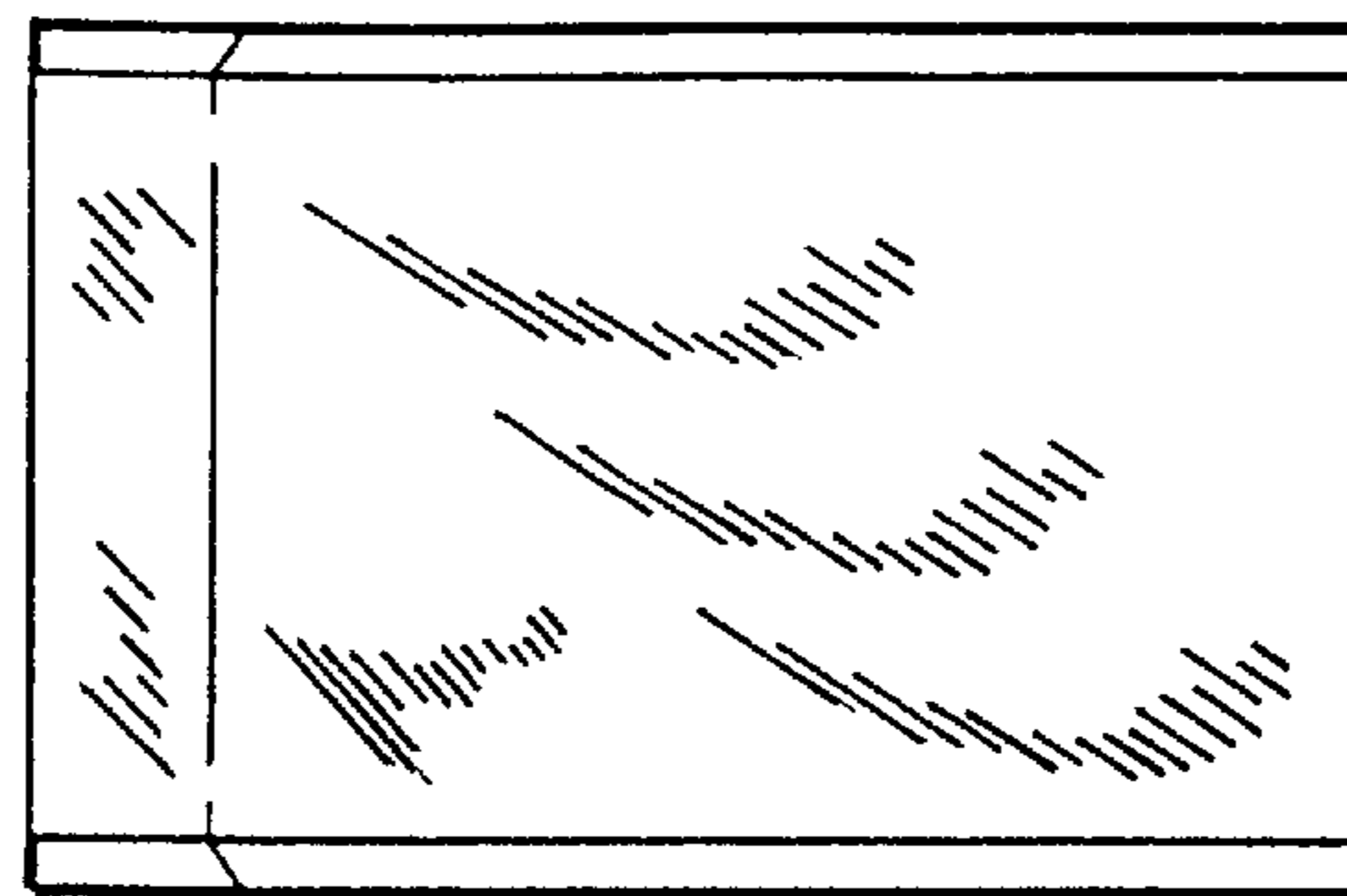
*FIG. 3*



*FIG. 4*

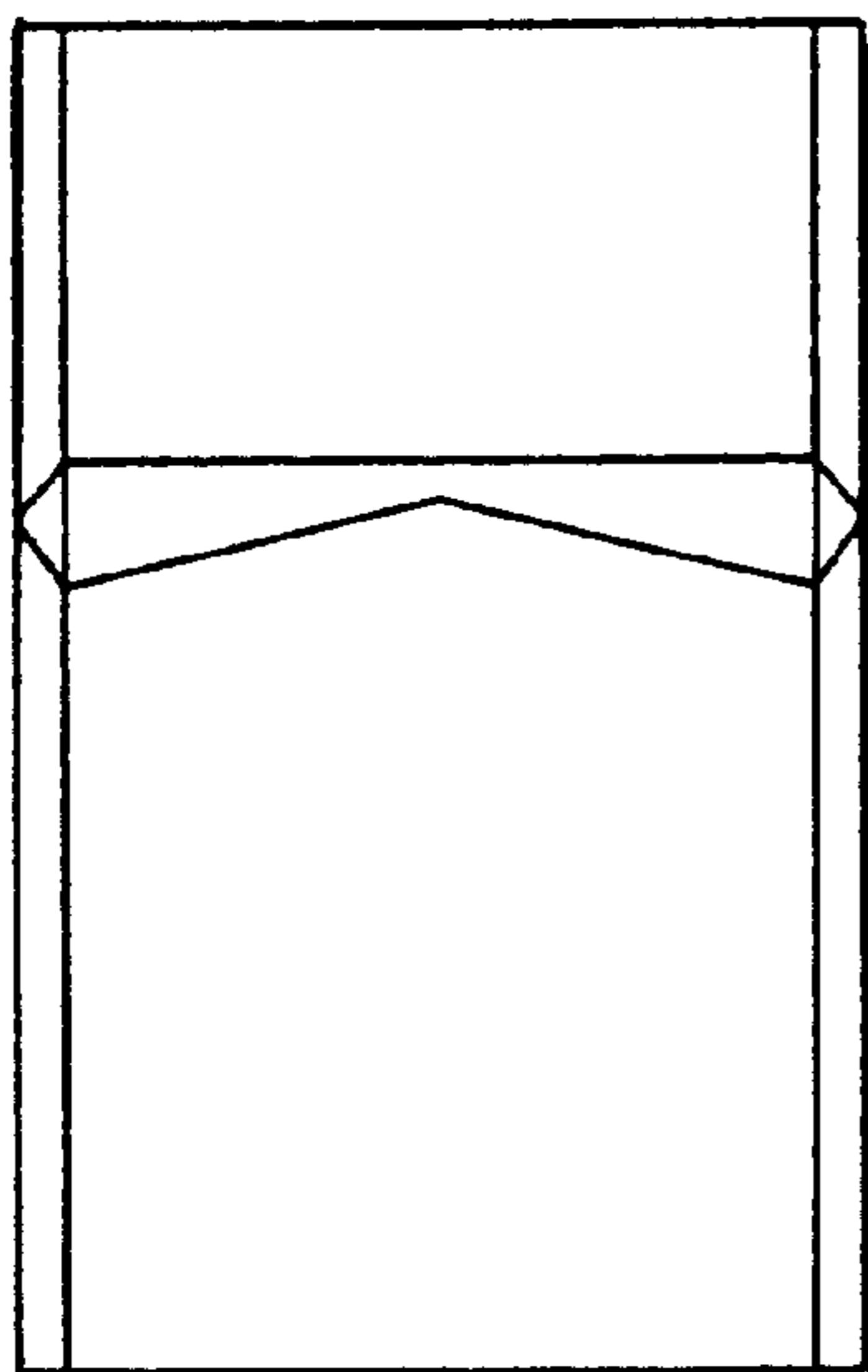


*FIG. 5*



*FIG. 6*

*FIG. 7*



*FIG. 8*

