



US00D448884B1

(12) **United States Design Patent**
Sehl

(10) **Patent No.:** **US D448,884 S**

(45) **Date of Patent:** **** Oct. 2, 2001**

(54) **INTERIOR ILLUMINATED LAMP IN THE SHAPE OF AN ORCA**

D. 441,882 * 5/2001 Lee D26/4

* cited by examiner

(75) Inventor: **Michael Sehl**, Taipei (CN)

Primary Examiner—Marcus A. Jackson

(73) Assignee: **Sehl Productions, Inc.**, Rochester, MN (US)

(74) *Attorney, Agent, or Firm*—Carl Rowold

(**) Term: **14 Years**

(57) **CLAIM**

The ornamental design for an interior illuminated lamp in the shape of an orca, as shown and described.

(21) Appl. No.: **29/137,323**

DESCRIPTION

(22) Filed: **Feb. 20, 2001**

FIG. 1 is a view in perspective of the present invention; FIG. 2 is a left side view of the present invention, with the cord broken away to indicate indeterminate length; FIG. 3 is a right side view of the present invention; FIG. 4 is a front view of the present invention; FIG. 5 is a back view of the present invention; FIG. 6 is a top view of the present invention; and, FIG. 7 is a bottom view of the present invention.

(51) **LOC (7) Cl.** **26-03**

(52) **U.S. Cl.** **D26/98**

(58) **Field of Search** D26/93-112; D21/606; 362/410-414

(56) **References Cited**

U.S. PATENT DOCUMENTS

D. 425,649 * 5/2000 Wang D26/98

1 Claim, 2 Drawing Sheets

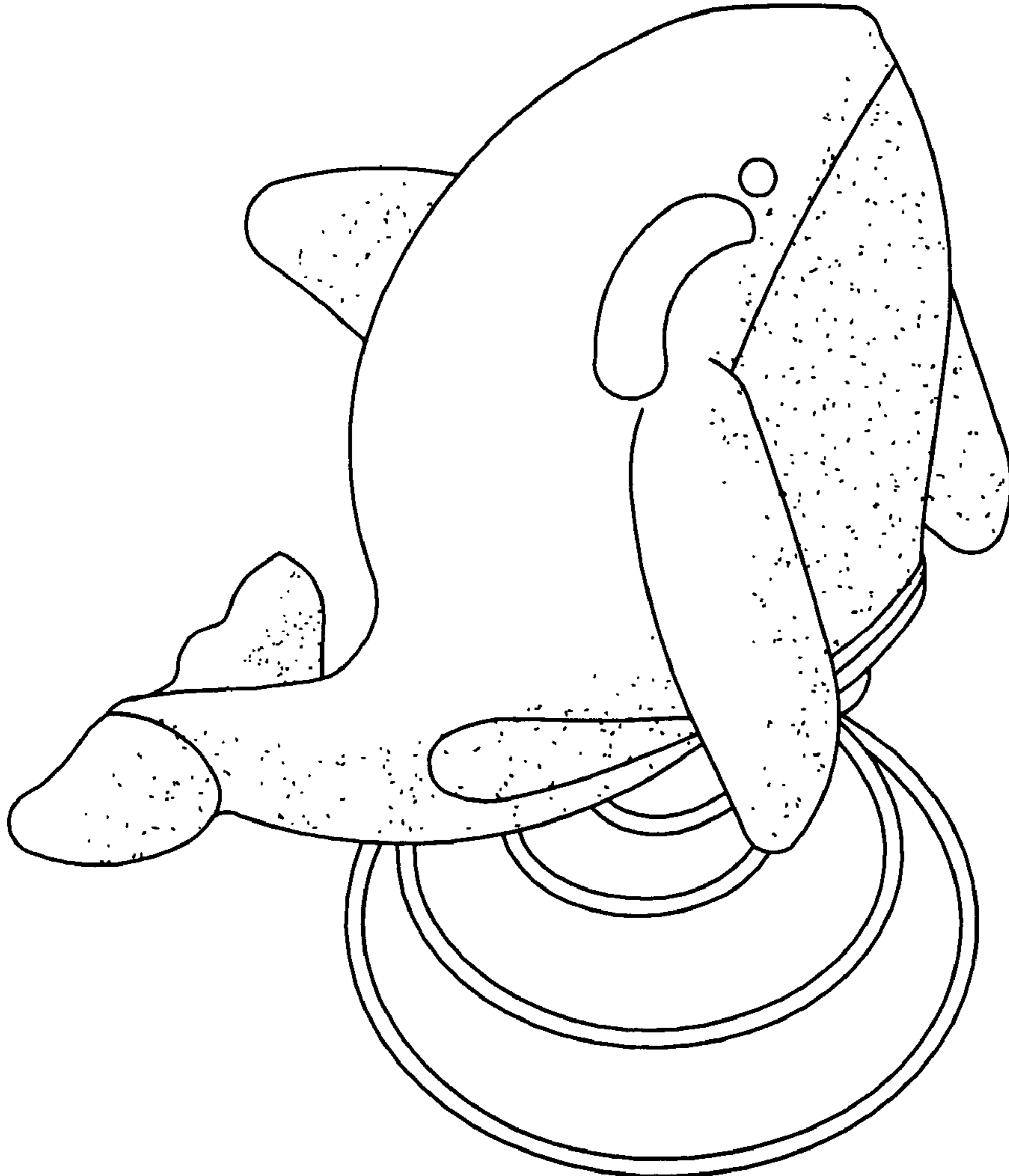

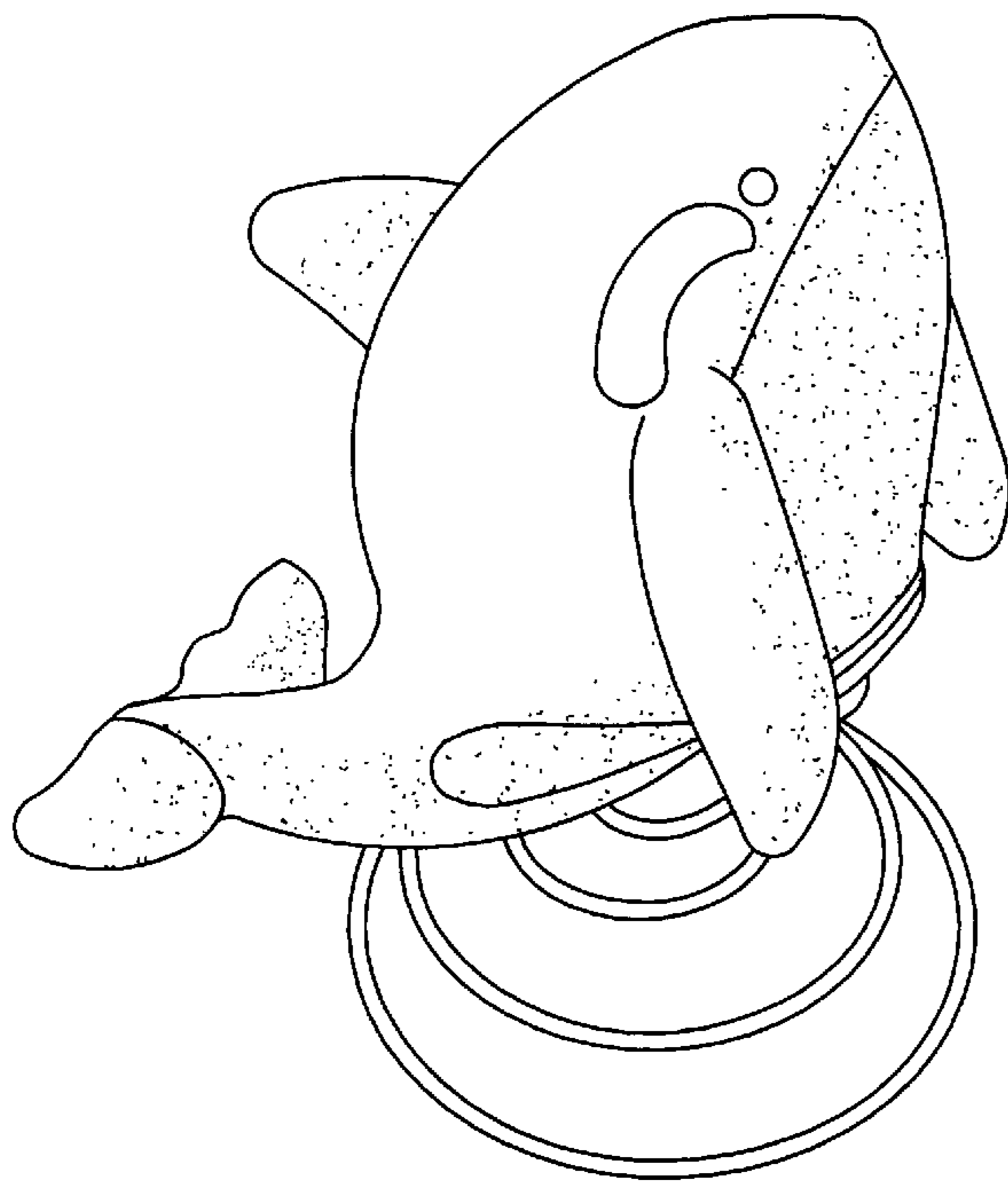

FIG. 1

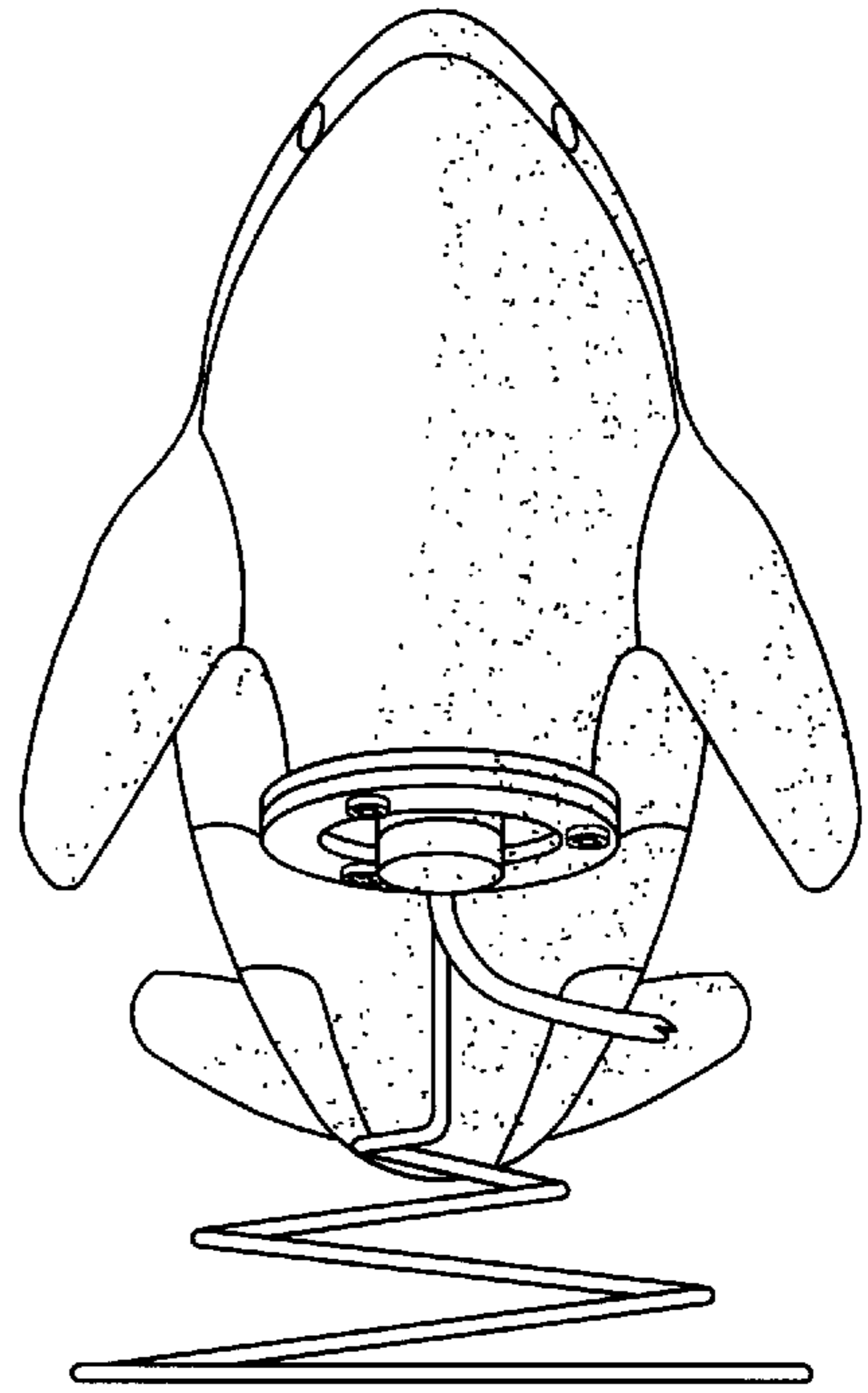

FIG. 4

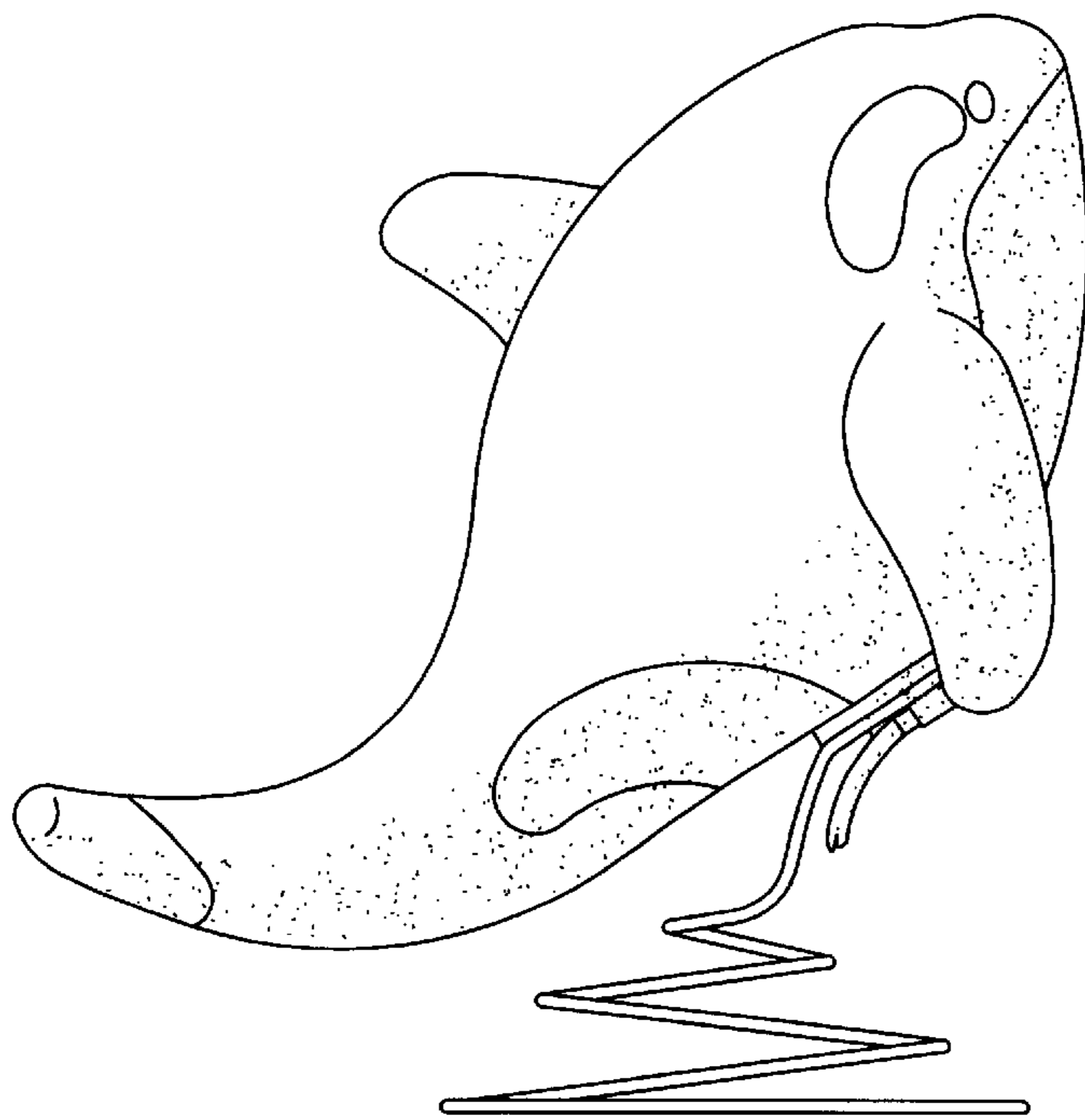

FIG. 2

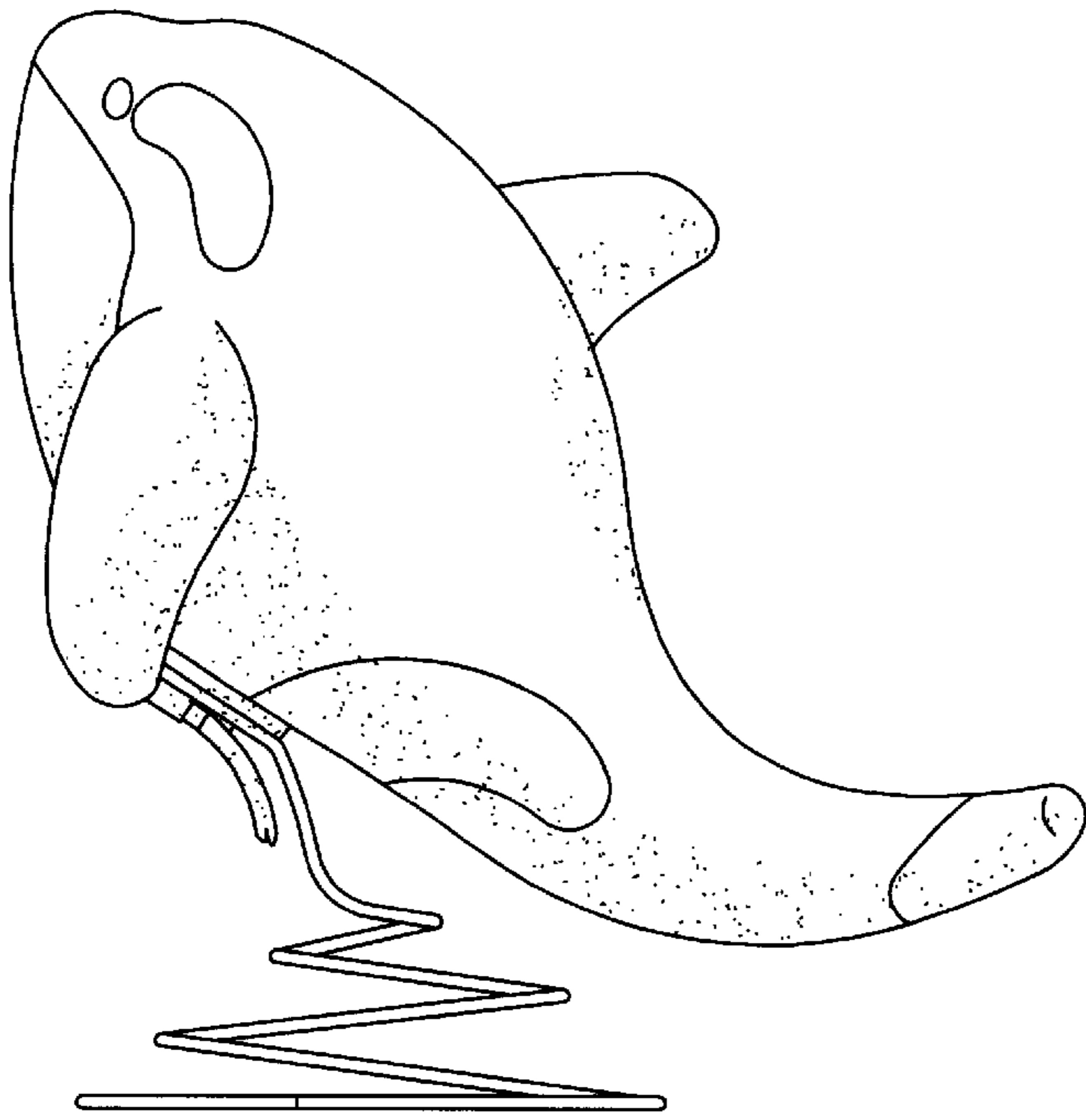

FIG. 3

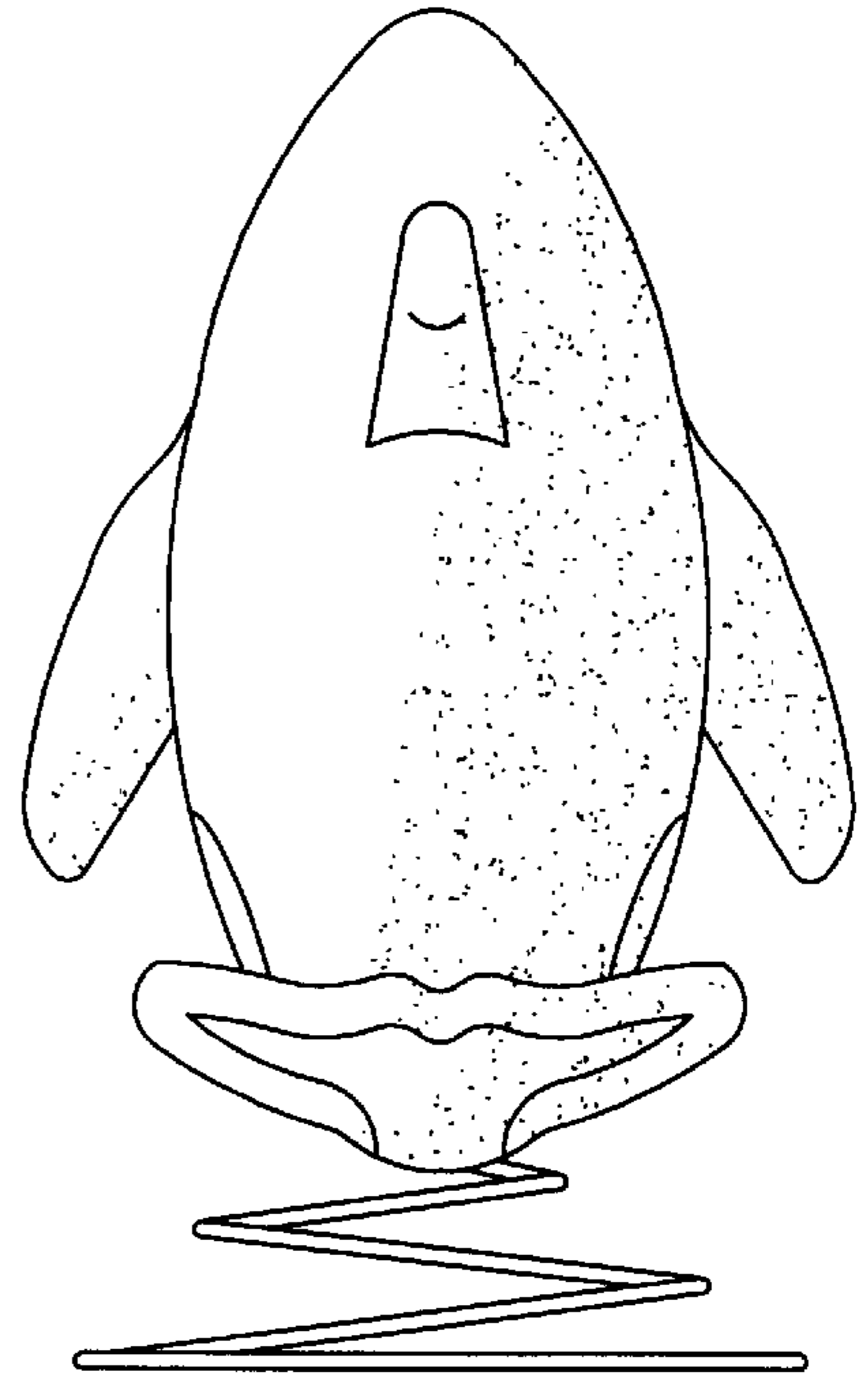

FIG. 5

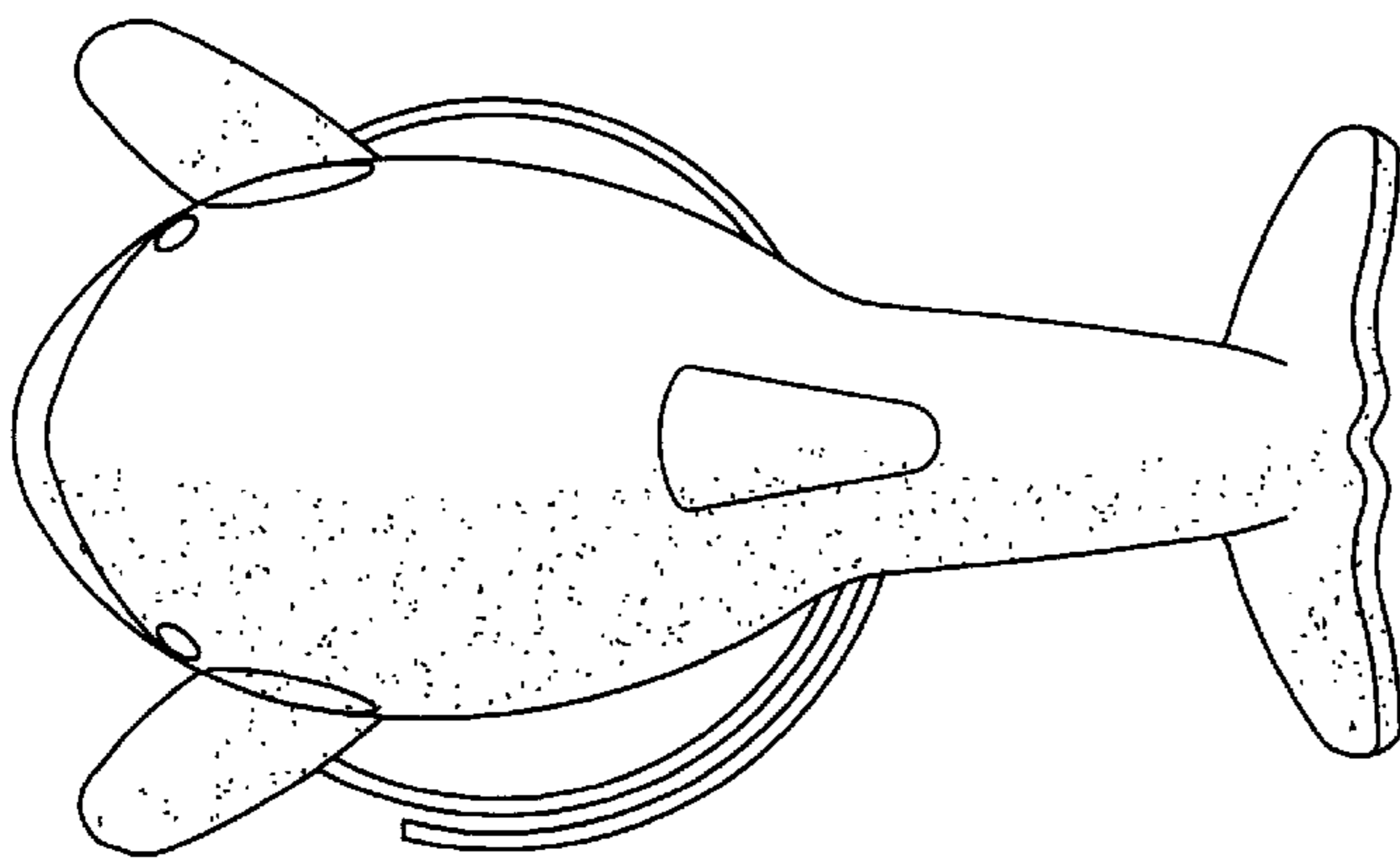

FIG. 6

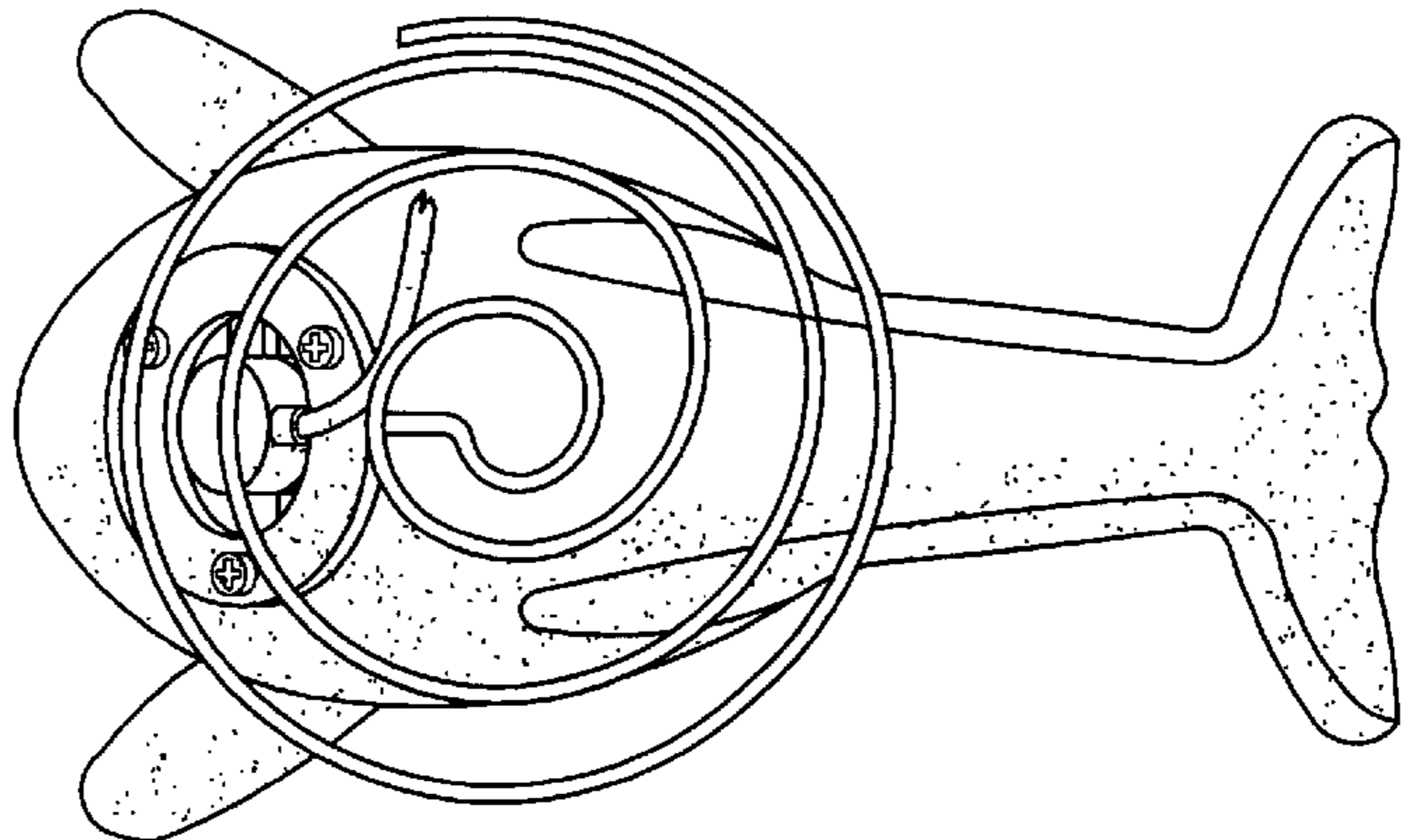

FIG. 7