



US00D448860B1

(12) **United States Design Patent**
Whitson

(10) **Patent No.:** **US D448,860 S**

(45) **Date of Patent:** **** Oct. 2, 2001**

(54) **DECORATIVE EDGING BLOCK**

(75) **Inventor:** **Robert L. Whitson**, West Bend, WI (US)

(73) **Assignee:** **Bend Industries, Inc.**, West Bend, WI (US)

(**) **Term:** **14 Years**

(21) **Appl. No.:** **29/134,640**

(22) **Filed:** **Dec. 22, 2000**

(51) **LOC (7) Cl.** **25-01**

(52) **U.S. Cl.** **D25/113**

(58) **Field of Search** D25/102, 113-118, D25/164; D21/484-486, 489-497, 503; 404/27-31; 52/102, 578-582.2, 596-609

(56) **References Cited**

U.S. PATENT DOCUMENTS

D. 336,140	*	6/1993	Lavery	D25/113
3,087,279	*	4/1963	Thompson	D25/119 X
4,976,063	*	12/1990	Young	52/102 X
4,986,042	*	1/1991	Richardt	52/102

FOREIGN PATENT DOCUMENTS

2414674	*	10/1975	(DE)	D25/113 X
---------	---	---------	------	-------	-----------

OTHER PUBLICATIONS

Facing Tile Institute; Structural Clay Facing Tile Handbook, 59HB; Round top cove base #4D520A and #4D524R, p. 11.*

* cited by examiner

Primary Examiner—Louis S. Zarfes
Assistant Examiner—Robert A. Delehanty
(74) *Attorney, Agent, or Firm*—Sokol Law Office

(57) **CLAIM**

The ornamental design of a decorative edging block, as shown and described.

DESCRIPTION

FIG. 1 is a perspective view of a first embodiment of the decorative edging block showing the new design; with a vertical wall that spans the length of the block.

FIG. 2 is a side, elevational view of the edging block of FIG. 1;

The side opposite FIG. 2 is a mirror image of FIG. 2;

FIG. 3 is a top, plan view of the edging block of FIG. 1;

FIG. 4 is a front, elevational view of the edging block of FIG. 1;

FIG. 5 is a bottom, plan view of the edging block of FIG. 1; and,

FIG. 6 is a rear, elevational view of the edging block of FIG. 1.

FIG. 7 is a perspective view of a second embodiment of the decorative edging block showing the new design, with a vertical wall that is recessed on one side of the block;

FIG. 8 is a side, elevational view of the edging block of FIG. 7;

The side opposite FIG. 8 is a mirror image of FIG. 2;

FIG. 9 is a top, plan view of the edging block of FIG. 7;

FIG. 10 is a front, elevational view of the edging block of FIG. 7;

FIG. 11 is a bottom, plan view of the edging block of FIG. 7; and,

FIG. 12 is a rear, elevational view of the edging block of FIG. 7.

1 Claim, 2 Drawing Sheets

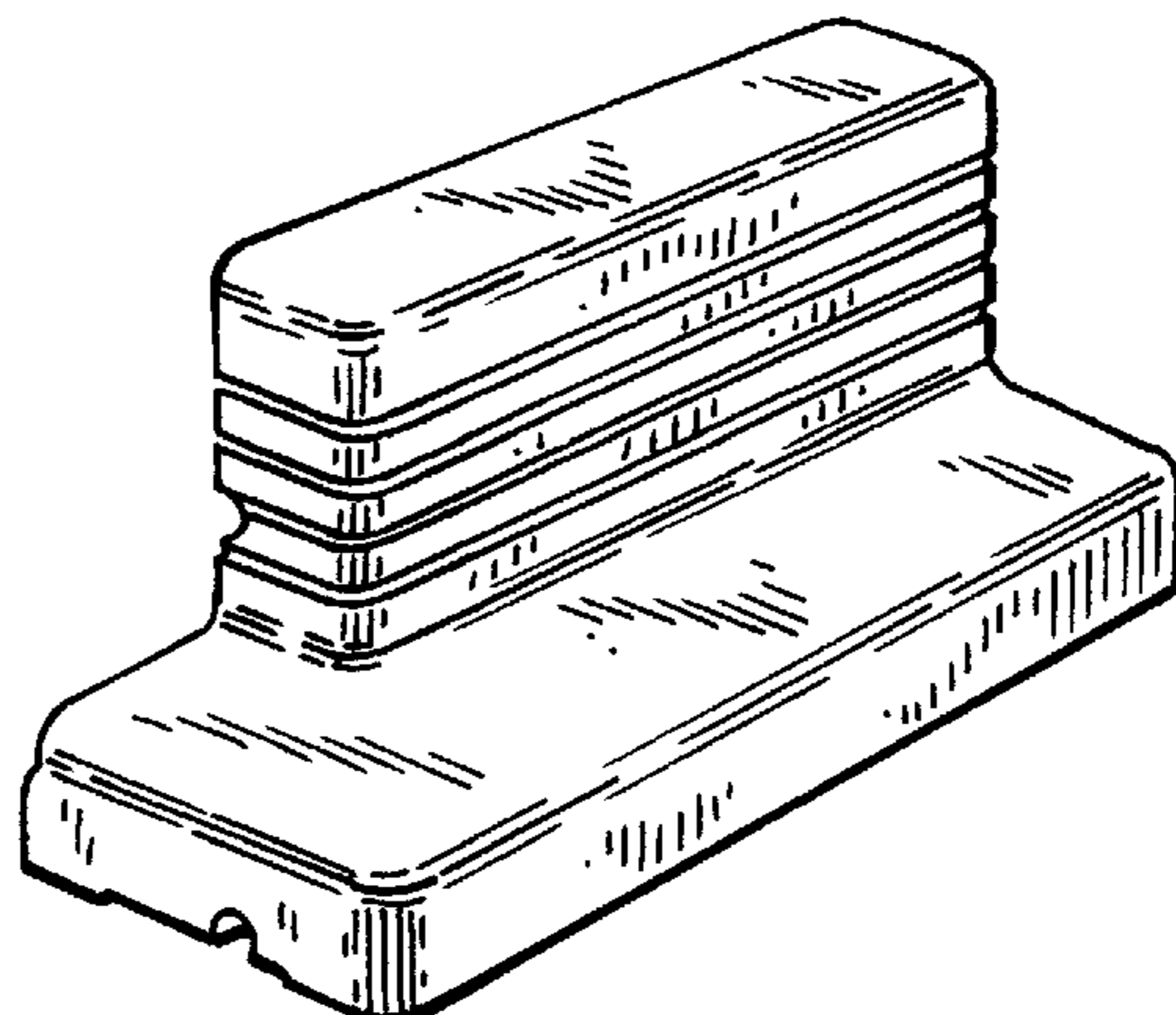
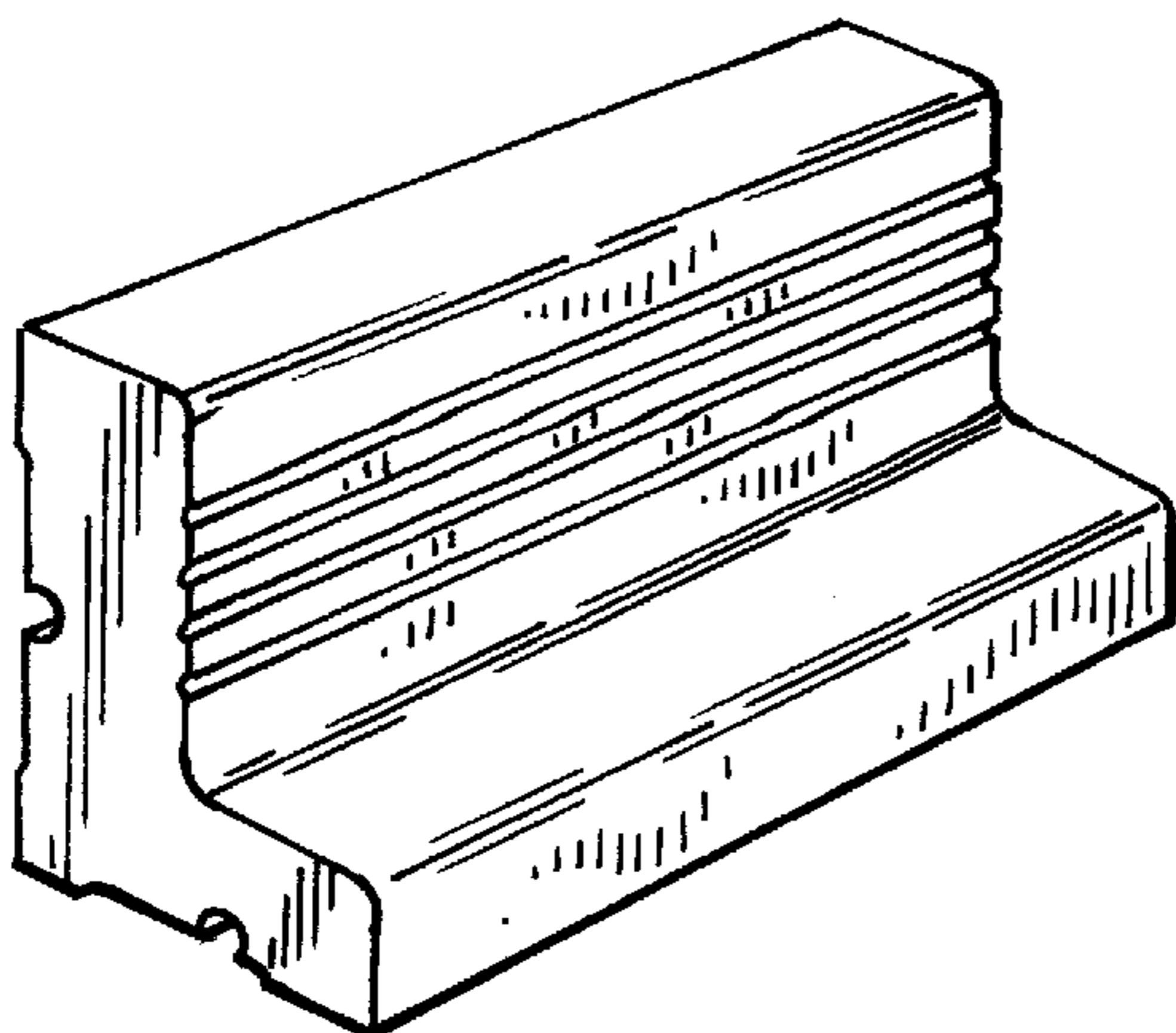

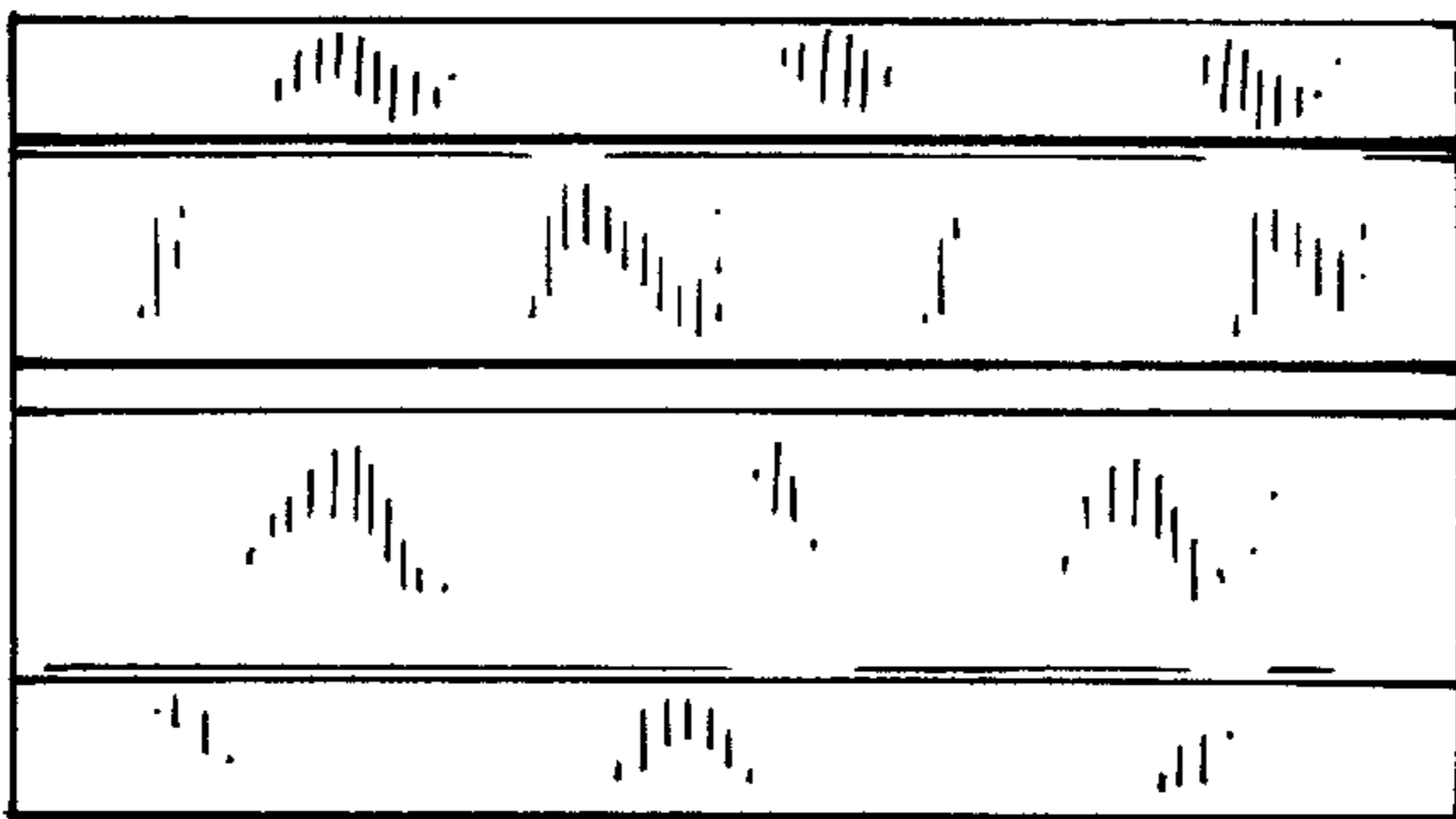
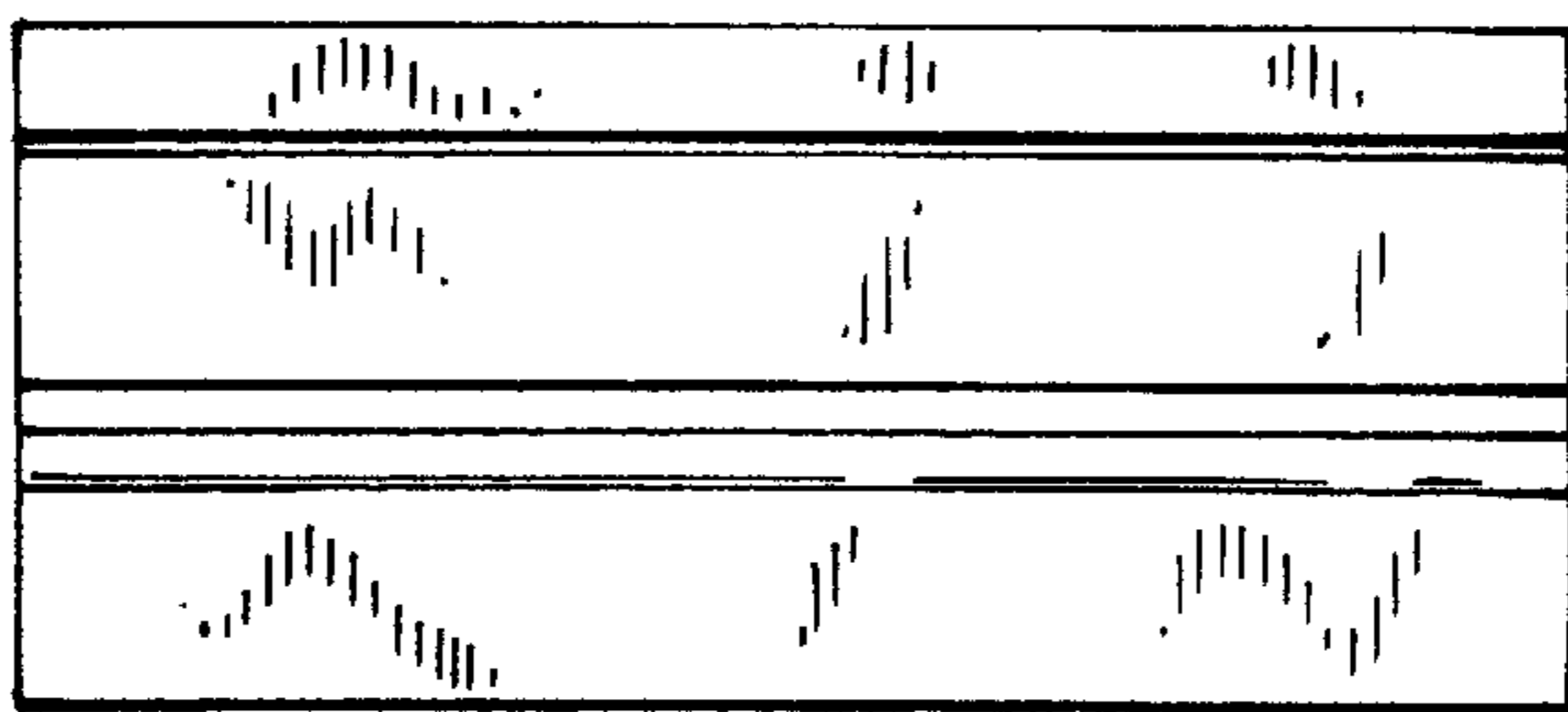
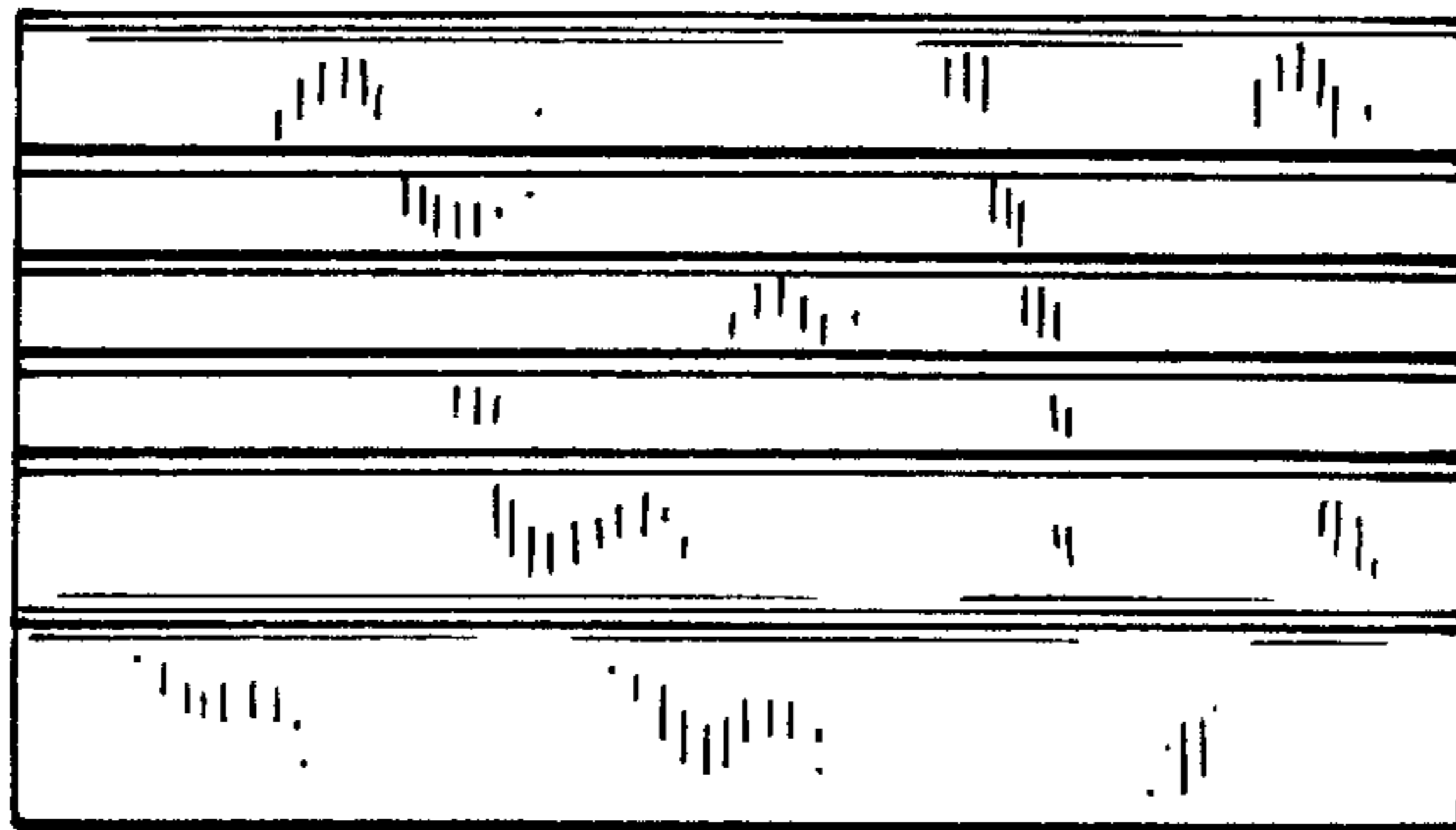
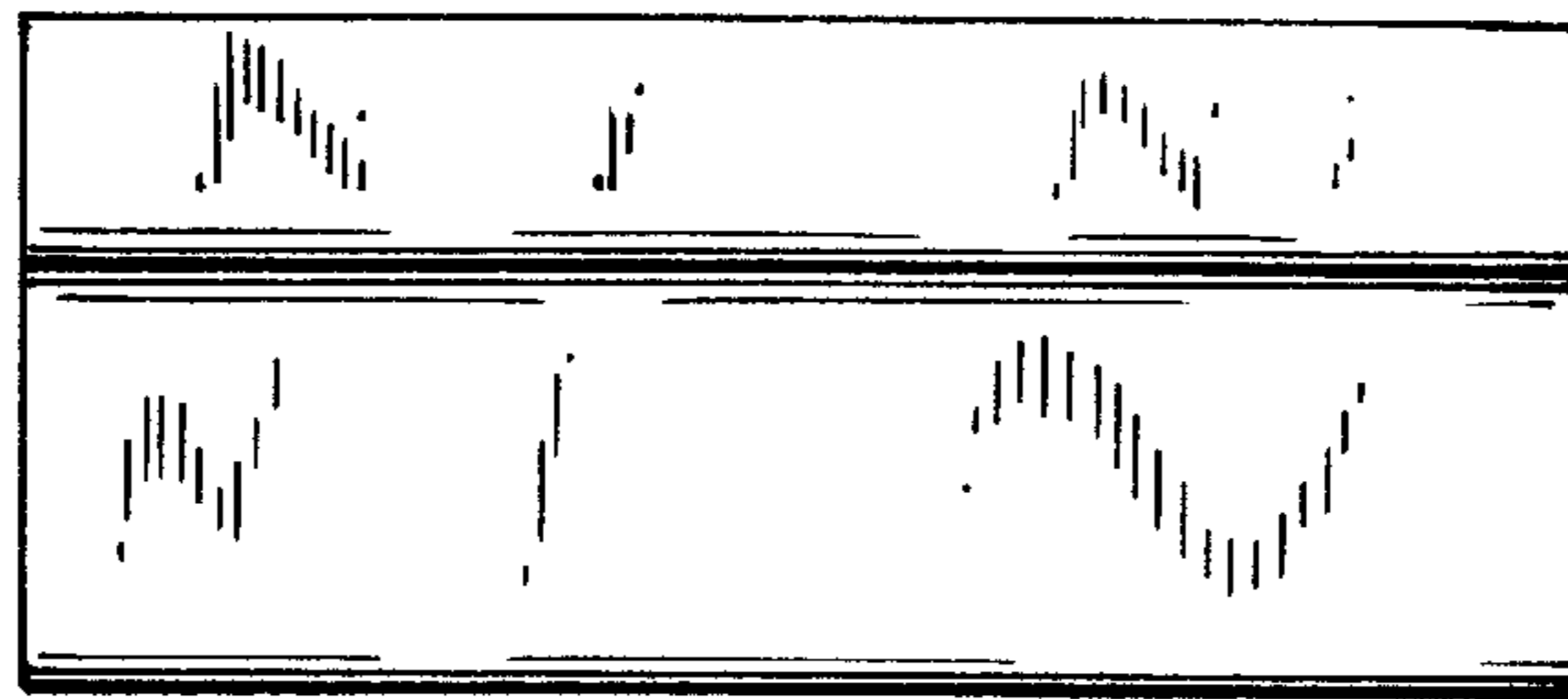
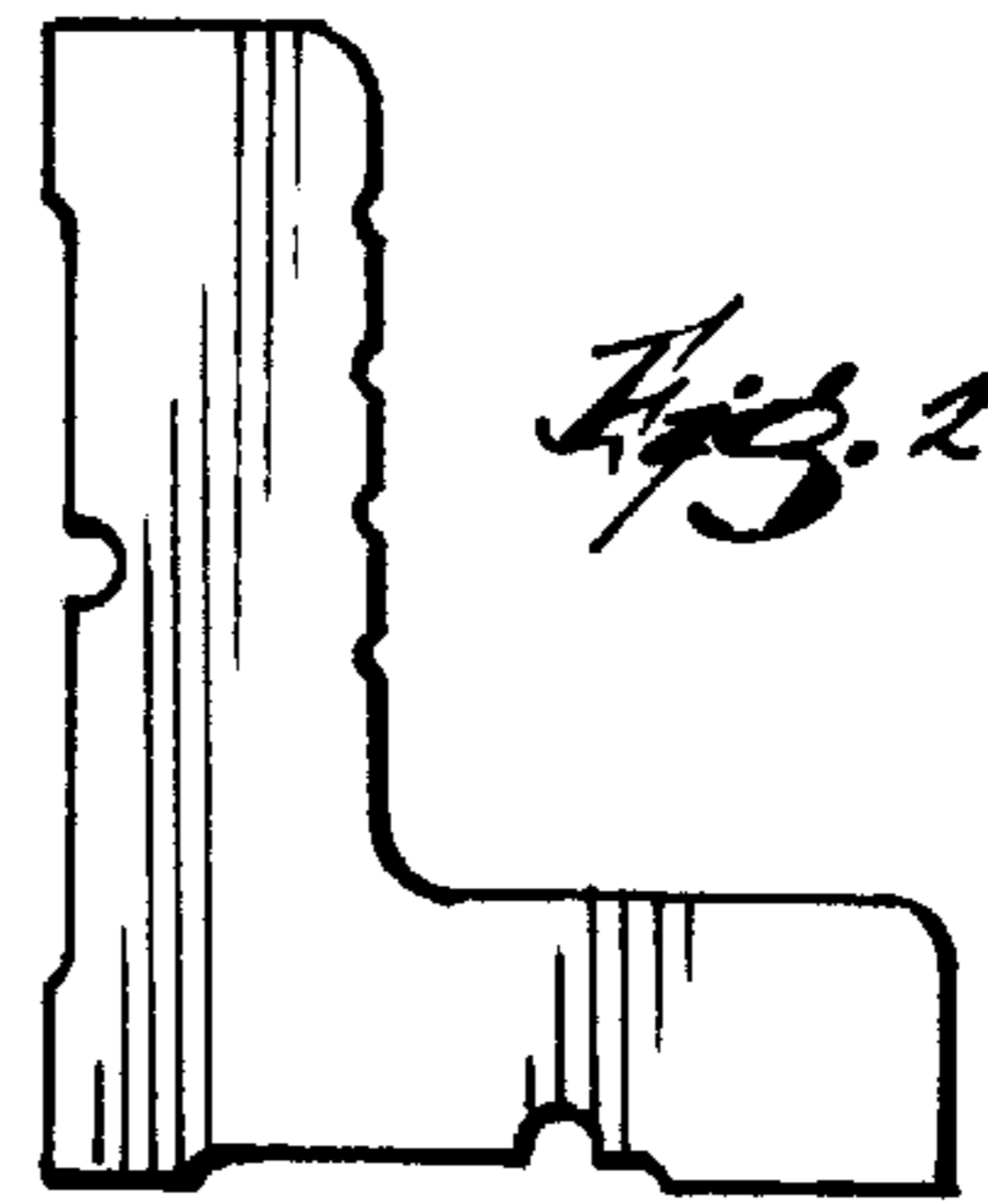
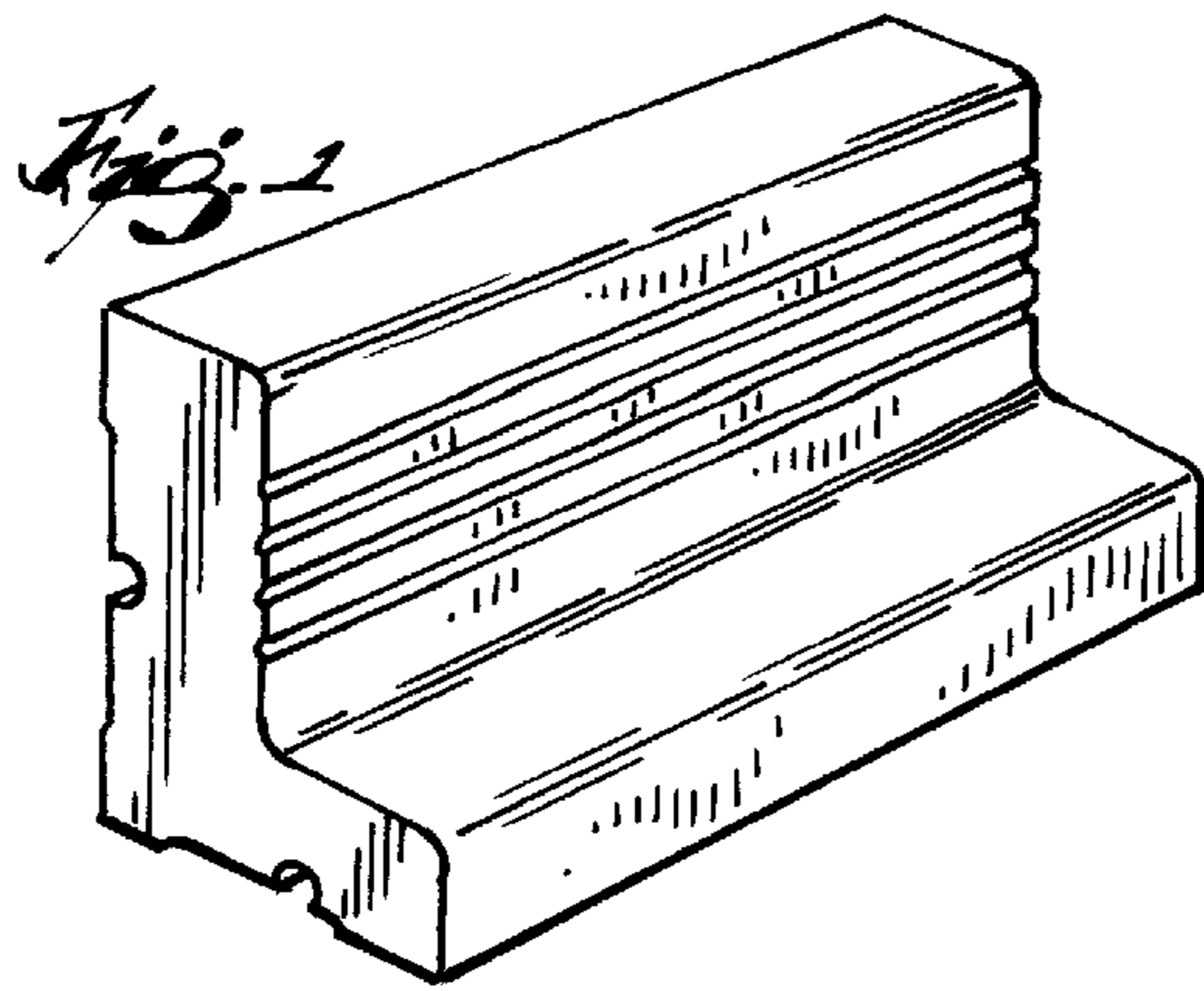

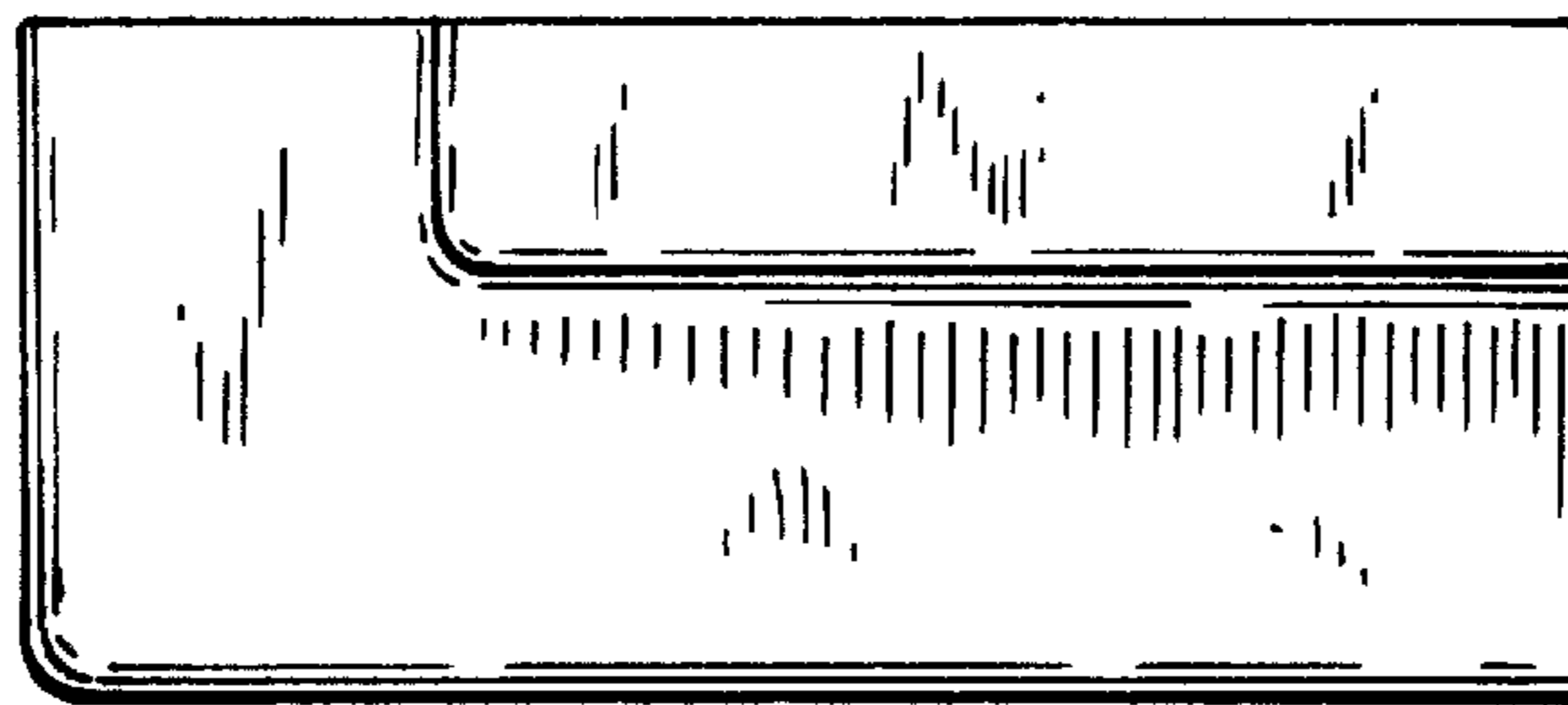
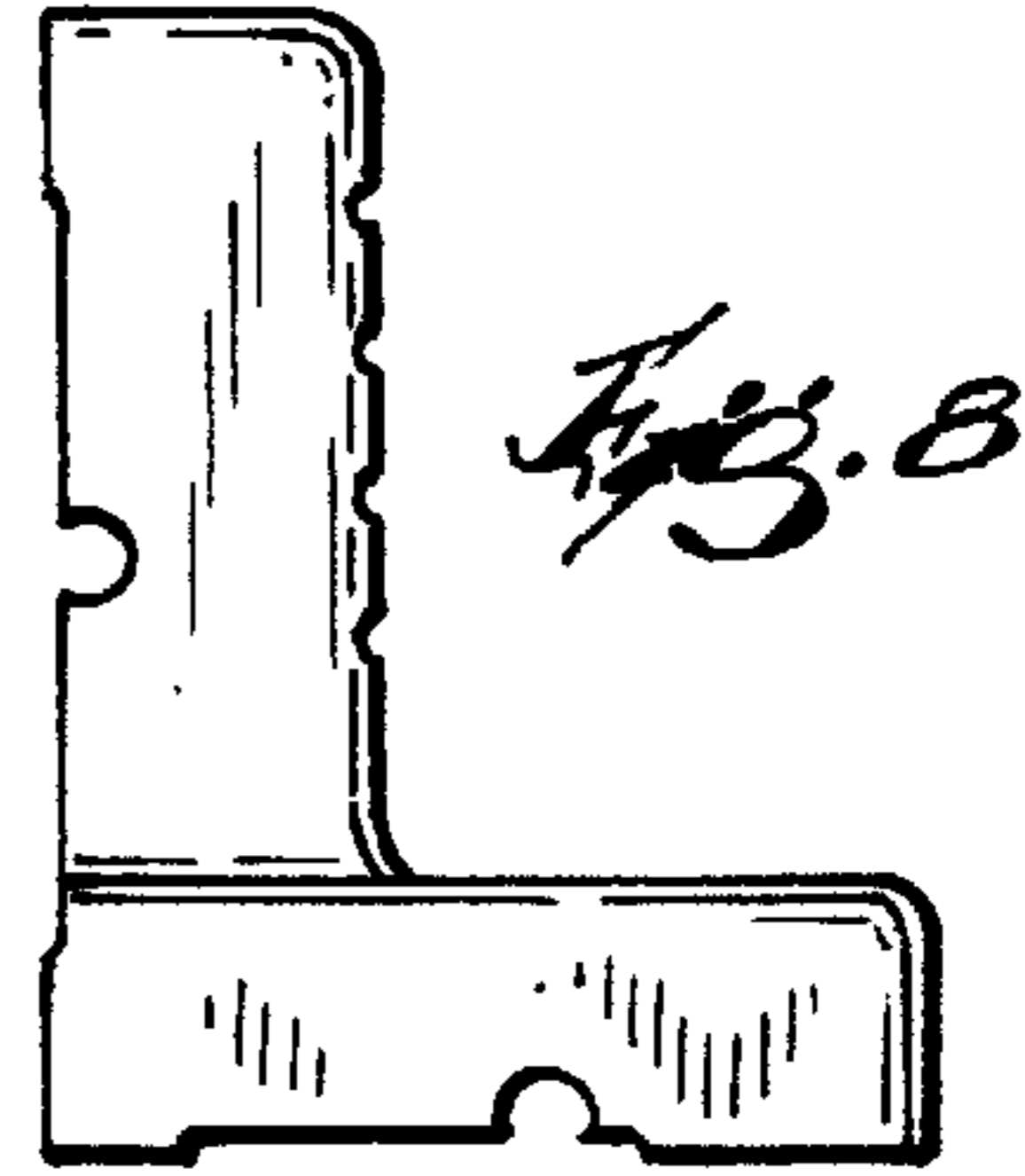
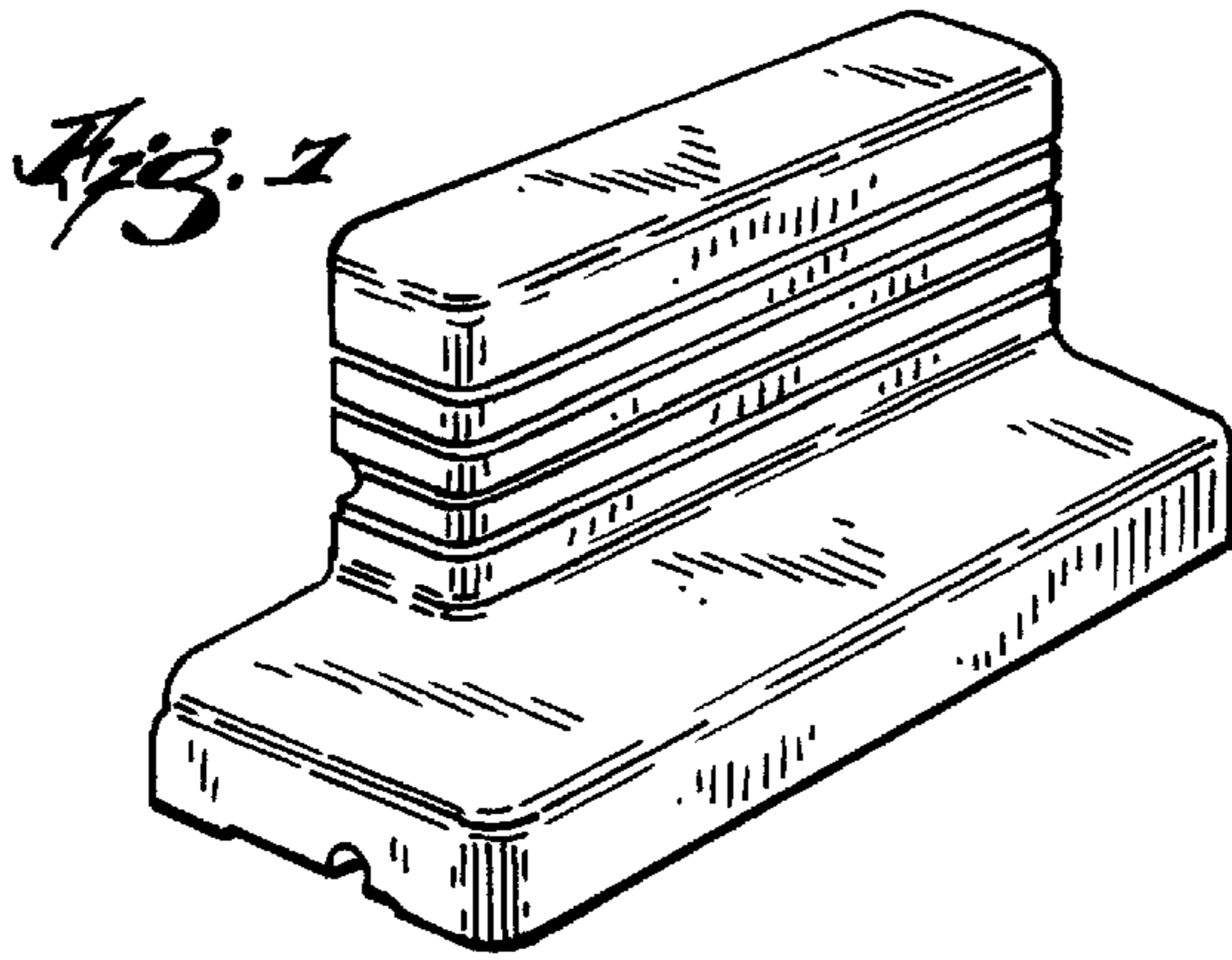

Fig. 9

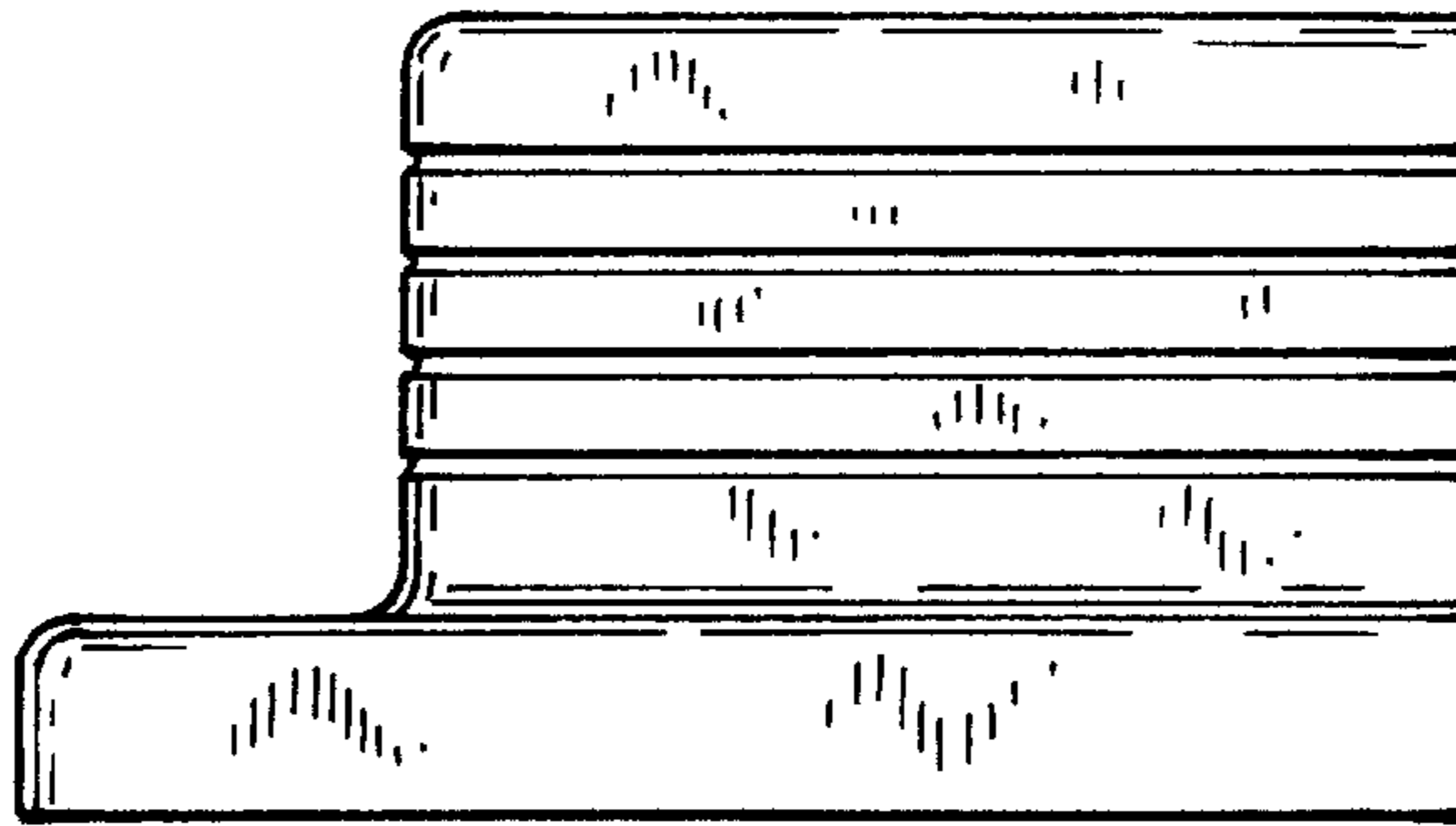

Fig. 10

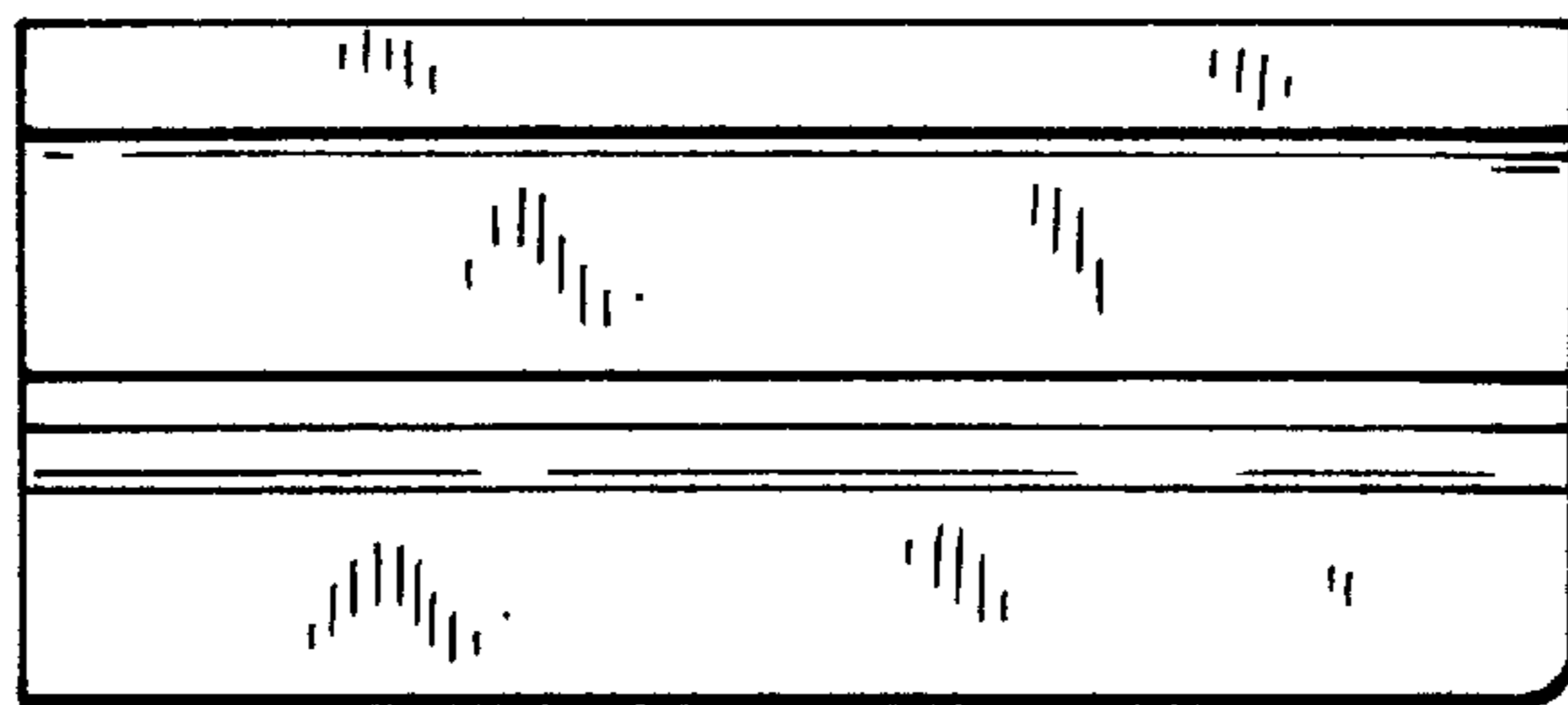

Fig. 11

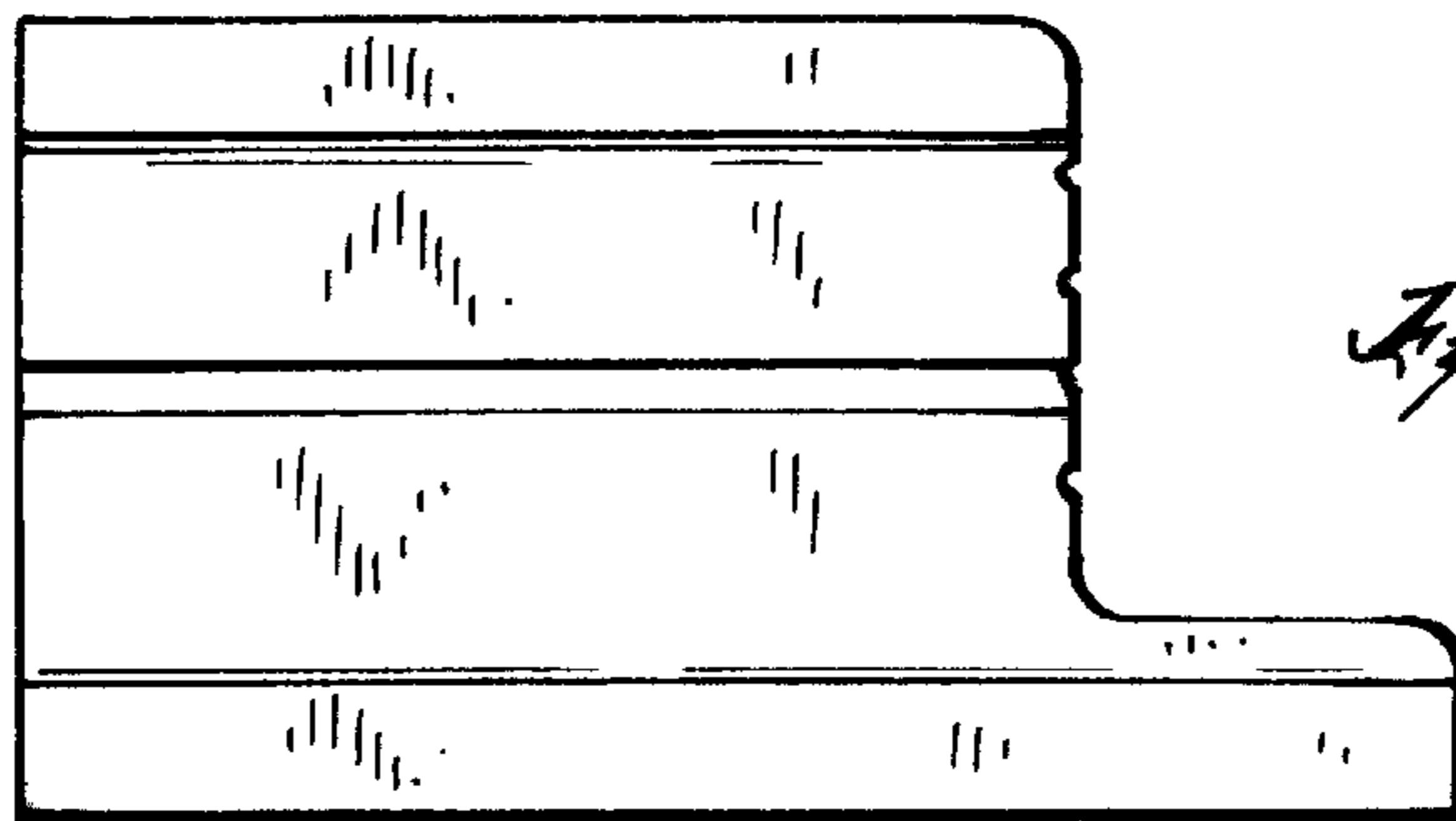

Fig. 12