



US00D448789B1

(12) **United States Design Patent**  
**Matsumura**

(10) **Patent No.:** **US D448,789 S**

(45) **Date of Patent:** **\*\* Oct. 2, 2001**

(54) **CAMERA**

(75) **Inventor:** **Yoshiyuki Matsumura, Yokosuka (JP)**

(73) **Assignee:** **Canon Kabushiki Kaisha, Tokyo (JP)**

(\*\*) **Term:** **14 Years**

(21) **Appl. No.:** **29/136,079**

(22) **Filed:** **Jan. 25, 2001**

(30) **Foreign Application Priority Data**

Aug. 2, 2000 (JP) ..... 12-021240

(51) **LOC (7) Cl.** ..... **16-01**

(52) **U.S. Cl.** ..... **D16/218; D16/212**

(58) **Field of Search** ..... **D16/200-204,**  
**D16/208, 209, 211-213, 218; 396/6, 448,**  
**535-541**

(56) **References Cited**

**U.S. PATENT DOCUMENTS**

- D. 369,372 \* 4/1996 Ishikawa et al. .... D16/218
- D. 394,076 5/1998 Matsumura et al. .... D16/209
- D. 395,665 6/1998 Matsumura et al. .... D16/209

- D. 416,035 \* 11/1999 Hamamura ..... D16/212
- D. 432,554 10/2000 Matsumura ..... D16/218
- D. 437,606 \* 2/2001 Suto et al. .... D16/218
- 5,649,235 \* 7/1997 Ando et al. .... 396/6
- 5,913,089 \* 6/1999 Ebe ..... 396/448

\* cited by examiner

*Primary Examiner*—Adir Aronovich

(74) *Attorney, Agent, or Firm*—Fitzpatrick, Cella, Harper & Scinto

(57) **CLAIM**

The ornamental design for a camera, as shown and described.

**DESCRIPTION**

FIG. 1 is a front view of a camera, showing my new design;  
FIG. 2 is a rear view thereof;  
FIG. 3 is a top plan view thereof;  
FIG. 4 is a bottom plan view thereof;  
FIG. 5 is a left side view thereof;  
FIG. 6 is a right side view thereof; and,  
FIG. 7 is a perspective view thereof.

**1 Claim, 3 Drawing Sheets**

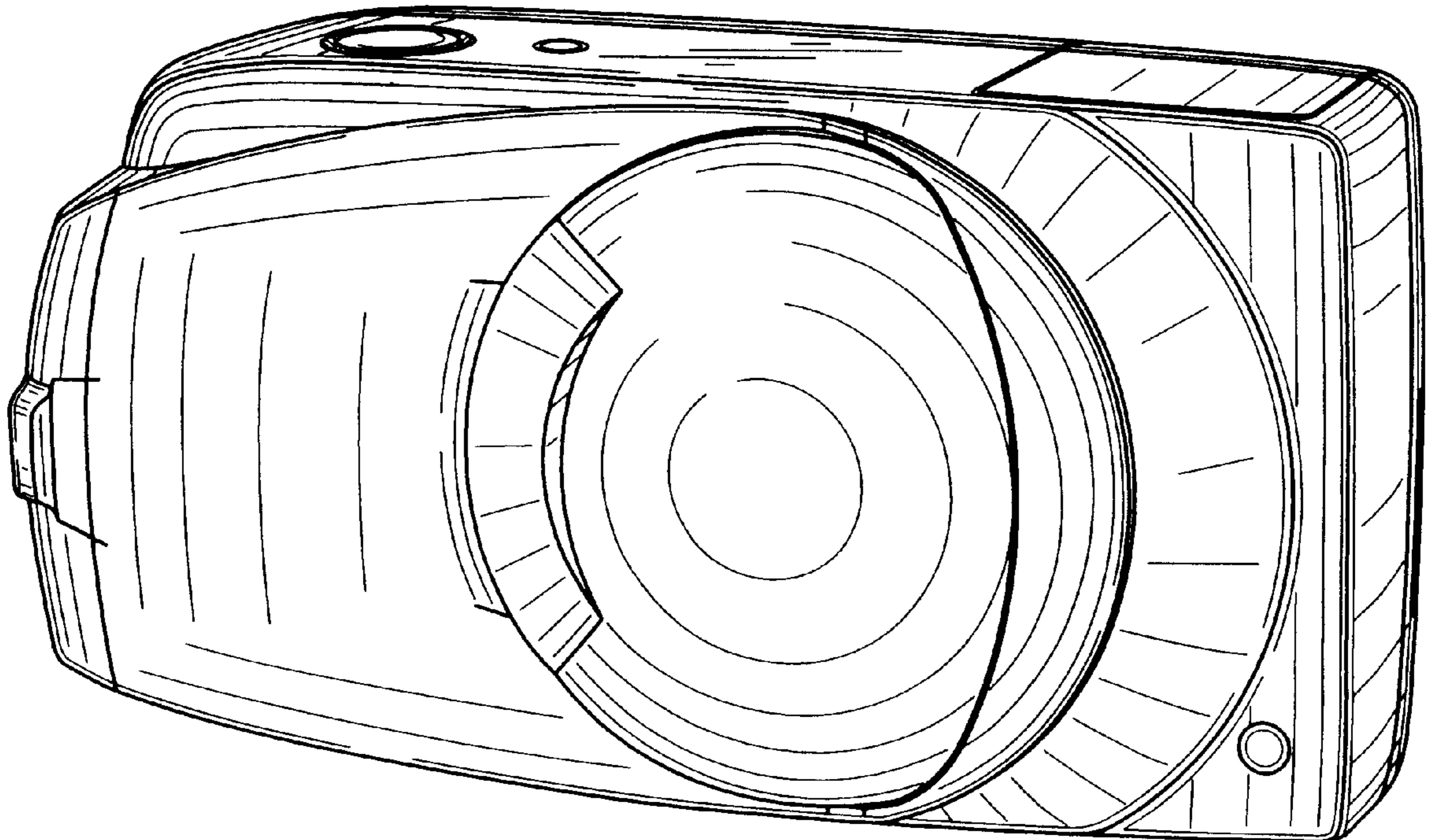

*FIG. 1*

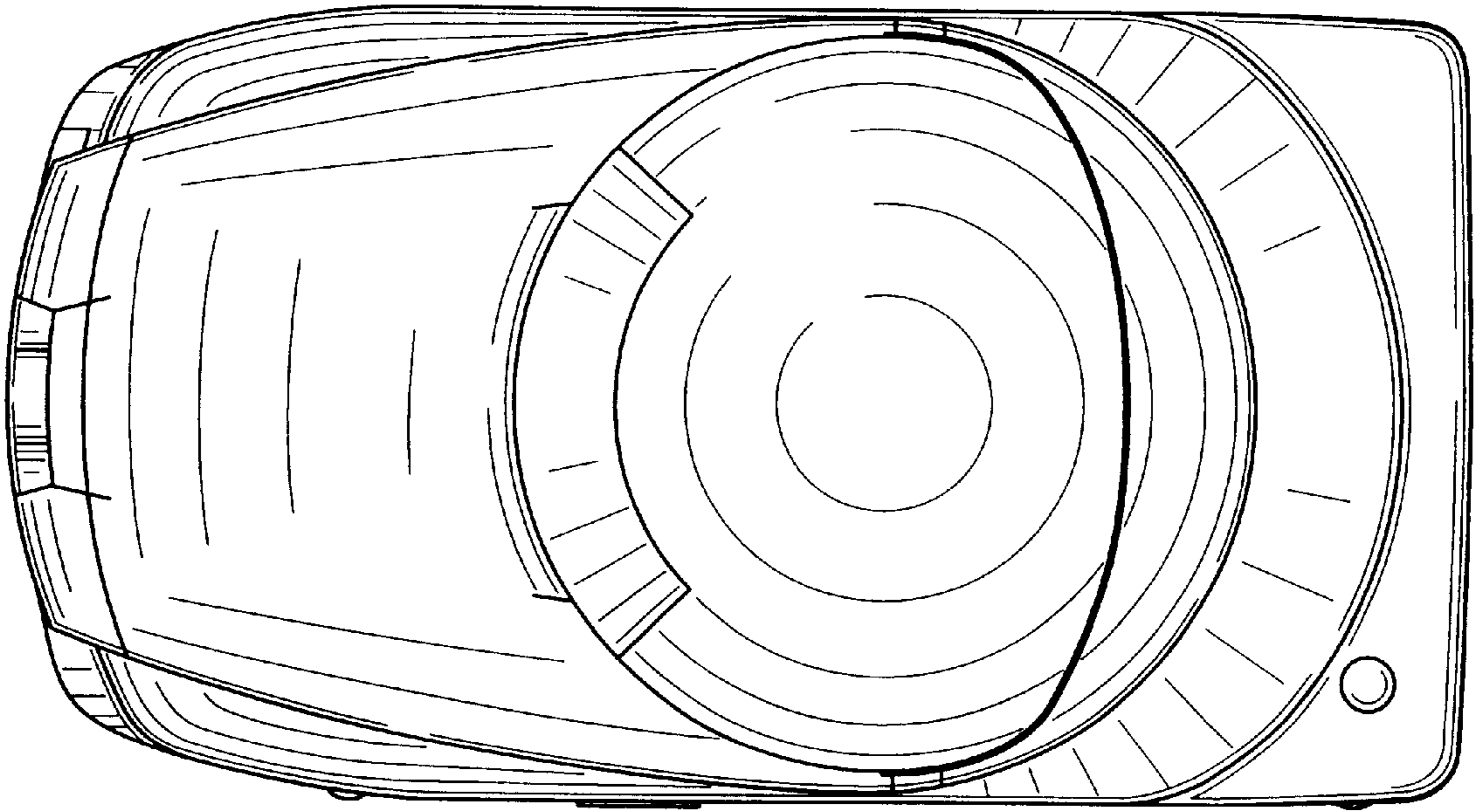

*FIG. 2*

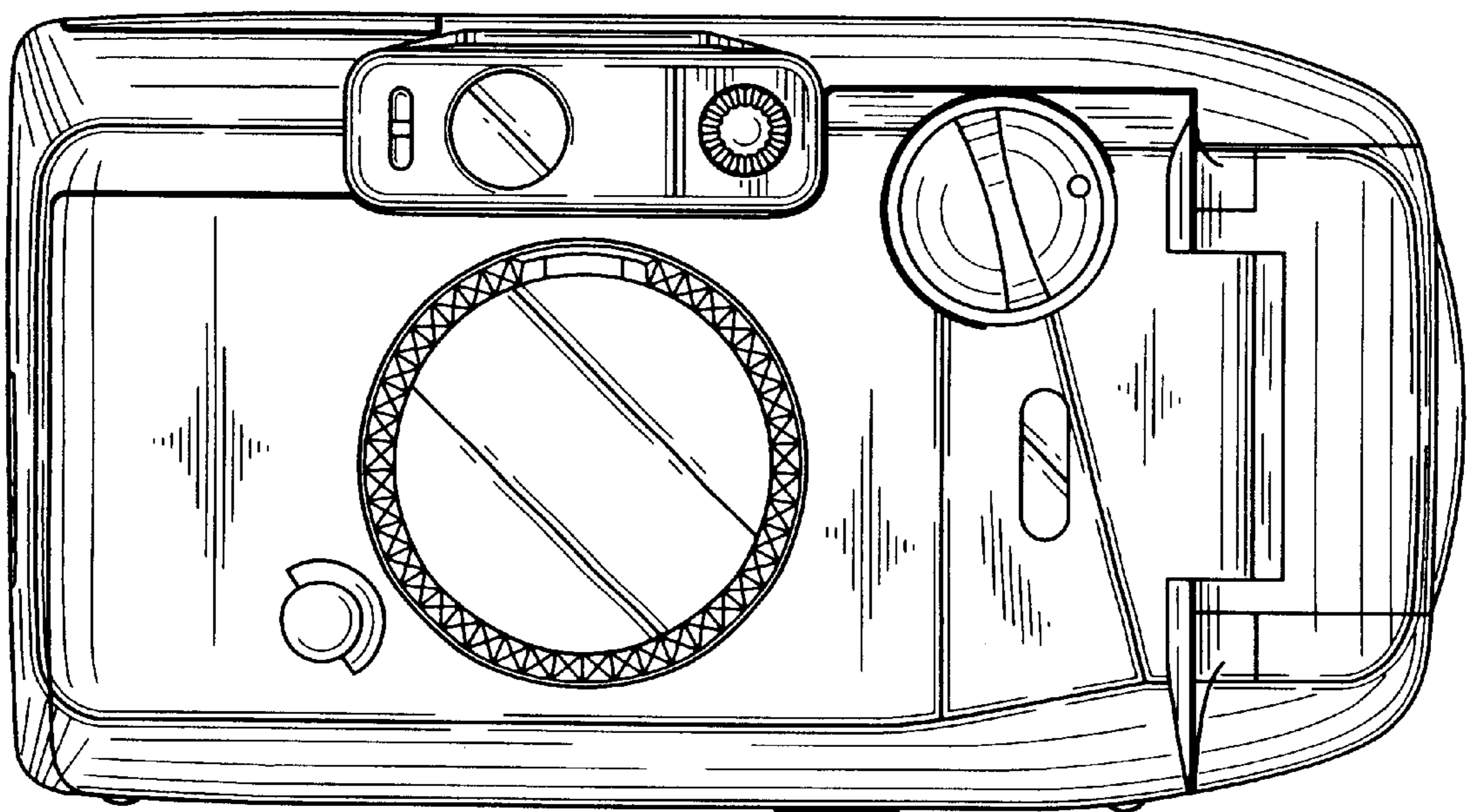

*FIG. 3*

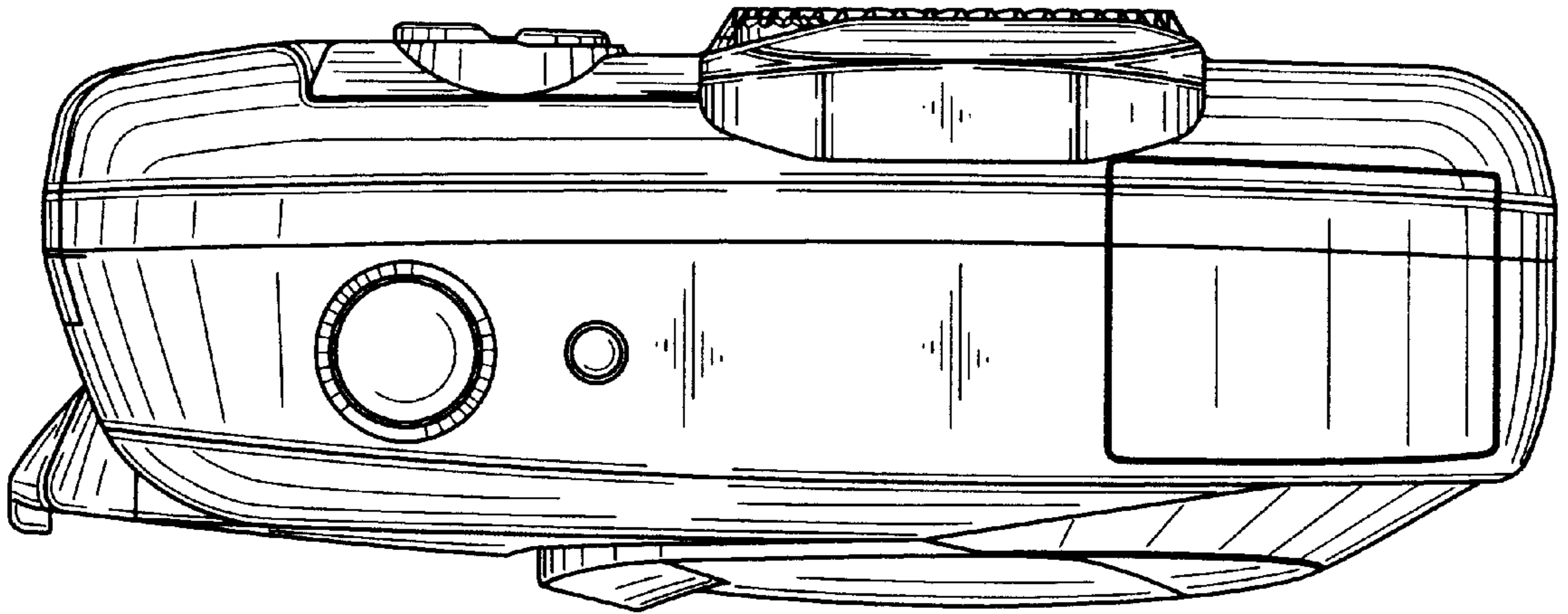

*FIG. 4*

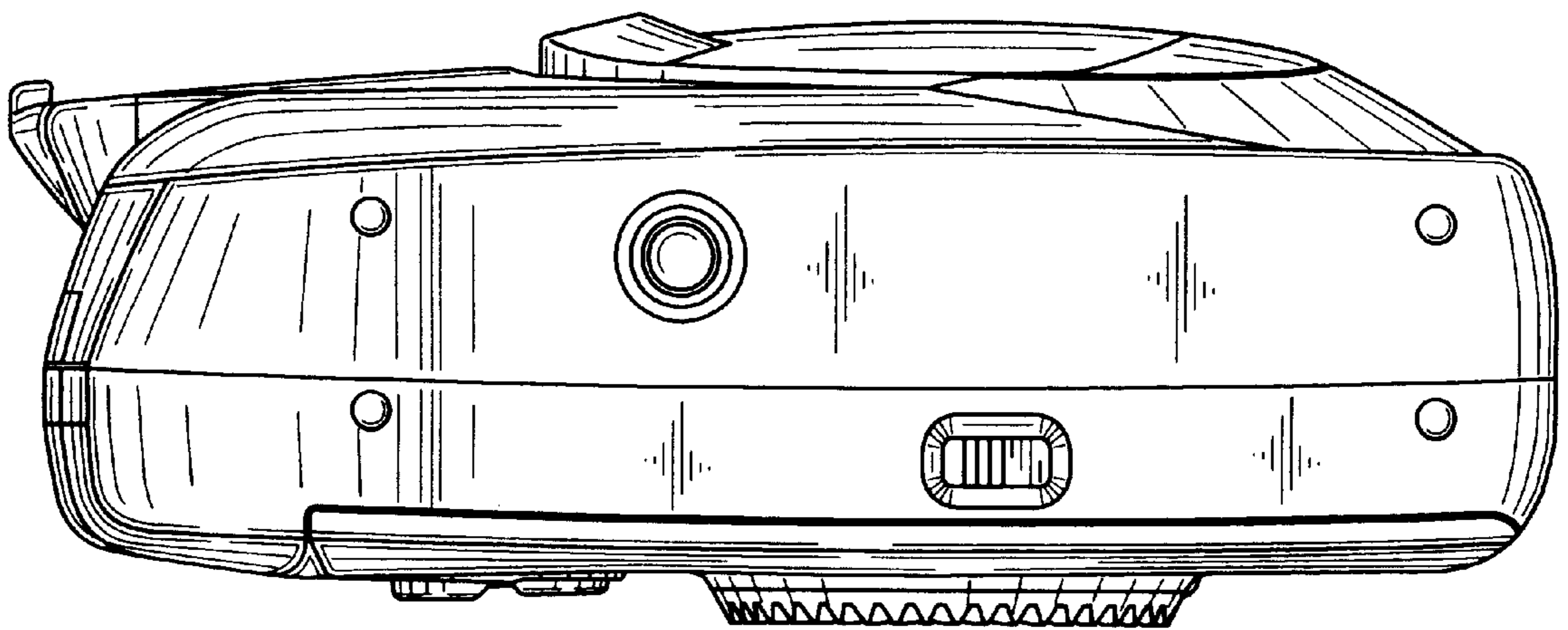

**FIG. 5**

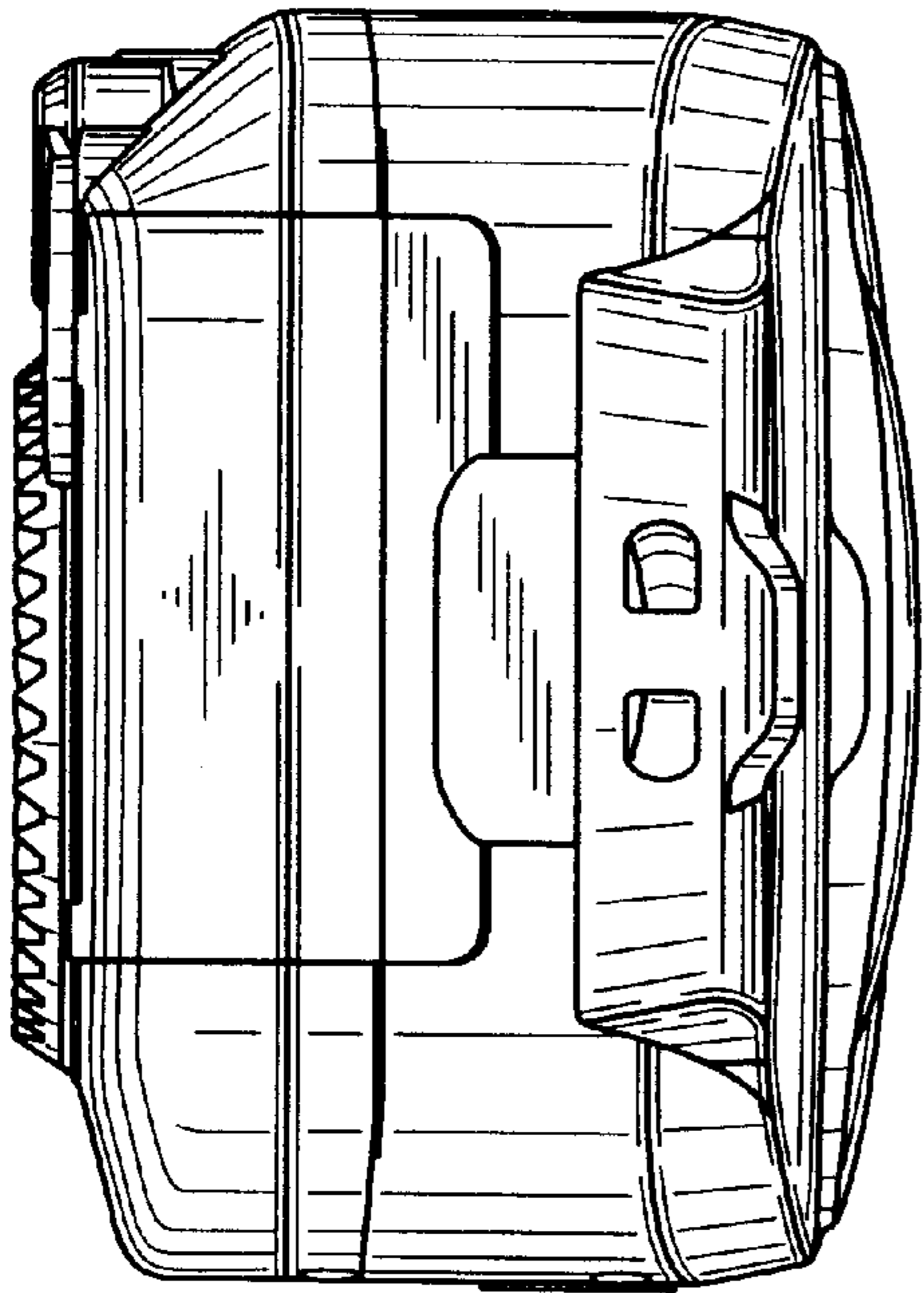

**FIG. 6**

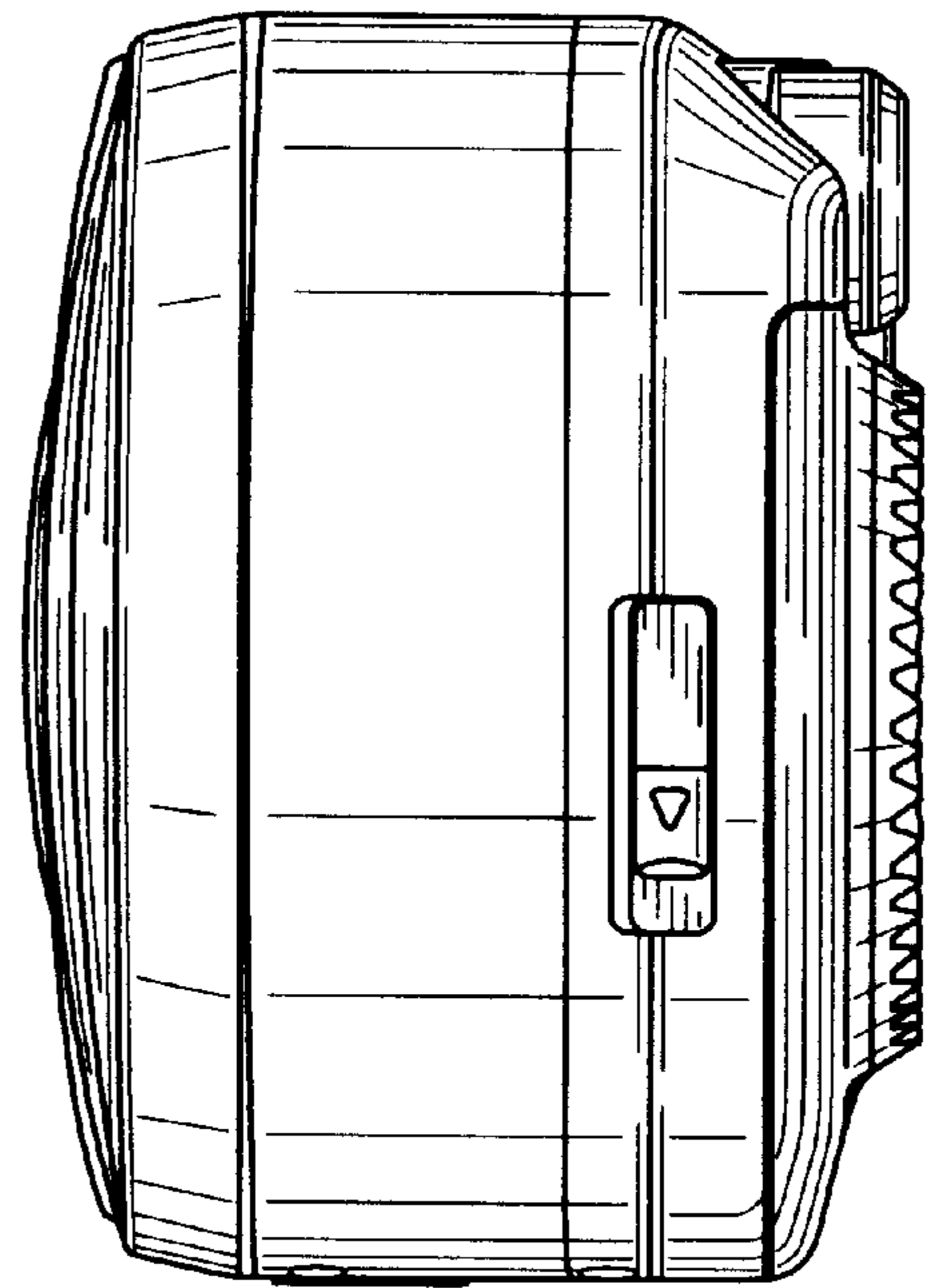

**FIG. 7**

