



US00D448723B1

(12) **United States Design Patent**
Zhu

(10) **Patent No.:** **US D448,723 S**

(45) **Date of Patent:** **** Oct. 2, 2001**

(54) **PORTABLE AUTOMOTIVE BOOSTER**

(75) Inventor: **Yun Hua Zhu**, Shanghai (CN)

(73) Assignee: **Shanghai Autopower Resource Co., Ltd.**, Shanghai (CN)

(**) Term: **14 Years**

(21) Appl. No.: **29/131,990**

(22) Filed: **Nov. 1, 2000**

(30) **Foreign Application Priority Data**

Jun. 27, 2000 (CN) 00 3 14995

(51) **LOC (7) Cl.** **13-02**

(52) **U.S. Cl.** **D13/107**

(58) **Field of Search** D13/106, 107,
D13/108, 118, 110; D14/149, 251, 253;
320/110-115, 105

(56) **References Cited**

U.S. PATENT DOCUMENTS

- D. 374,859 * 10/1996 Guay et al. D13/110
- D. 413,098 * 8/1999 Dayan D13/110
- D. 425,019 * 5/2000 Zheng D13/110
- D. 429,482 * 8/2000 Hussaini et al. D13/107
- D. 432,985 * 10/2000 Wan D13/107
- 5,589,292 12/1996 Rozon 429/170
- 5,793,185 * 8/1998 Prelec et al. 320/104
- 5,955,866 * 9/1999 Peng 320/105
- 5,982,138 * 11/1999 Krieger 320/105

6,002,235 * 12/1999 Clore 320/105

6,130,519 * 10/2000 Whiting et al. 320/105

6,155,870 * 12/2000 Valentine 439/504

* cited by examiner

Primary Examiner—Joel Sincavage

(74) *Attorney, Agent, or Firm*—BakerBotts LLP

(57) **CLAIM**

The ornamental design for a portable automotive booster, as shown and described.

DESCRIPTION

FIG. 1 is a perspective view of the portable automotive booster of the invention.

FIG. 2 is a front view of the portable automotive booster depicted in FIG. 1.

FIG. 3 is a rear view of the portable automotive booster depicted in FIG. 1.

FIG. 4 is a top view of the portable automotive booster depicted in FIG. 1.

FIG. 5 is a bottom view of view of the portable automotive booster depicted in FIG. 1.

FIG. 6 is a left side view of view of the portable automotive booster depicted in FIG. 1.

FIG. 7 is a right side view of the portable automotive booster depicted in FIG. 1; and,

FIG. 8 is another perspective view of the portable automotive booster depicted in FIG. 1, in an alternate position.

1 Claim, 8 Drawing Sheets

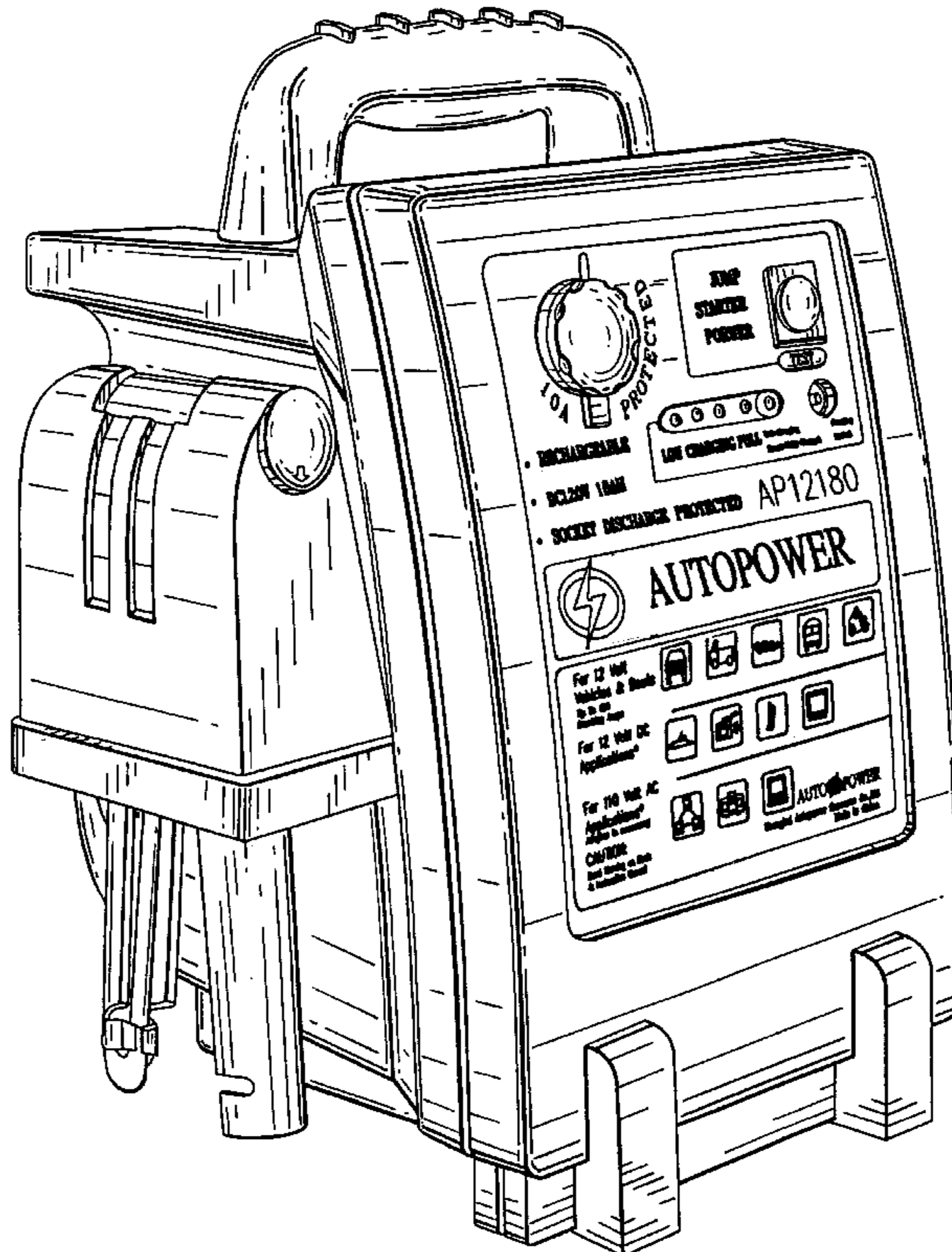

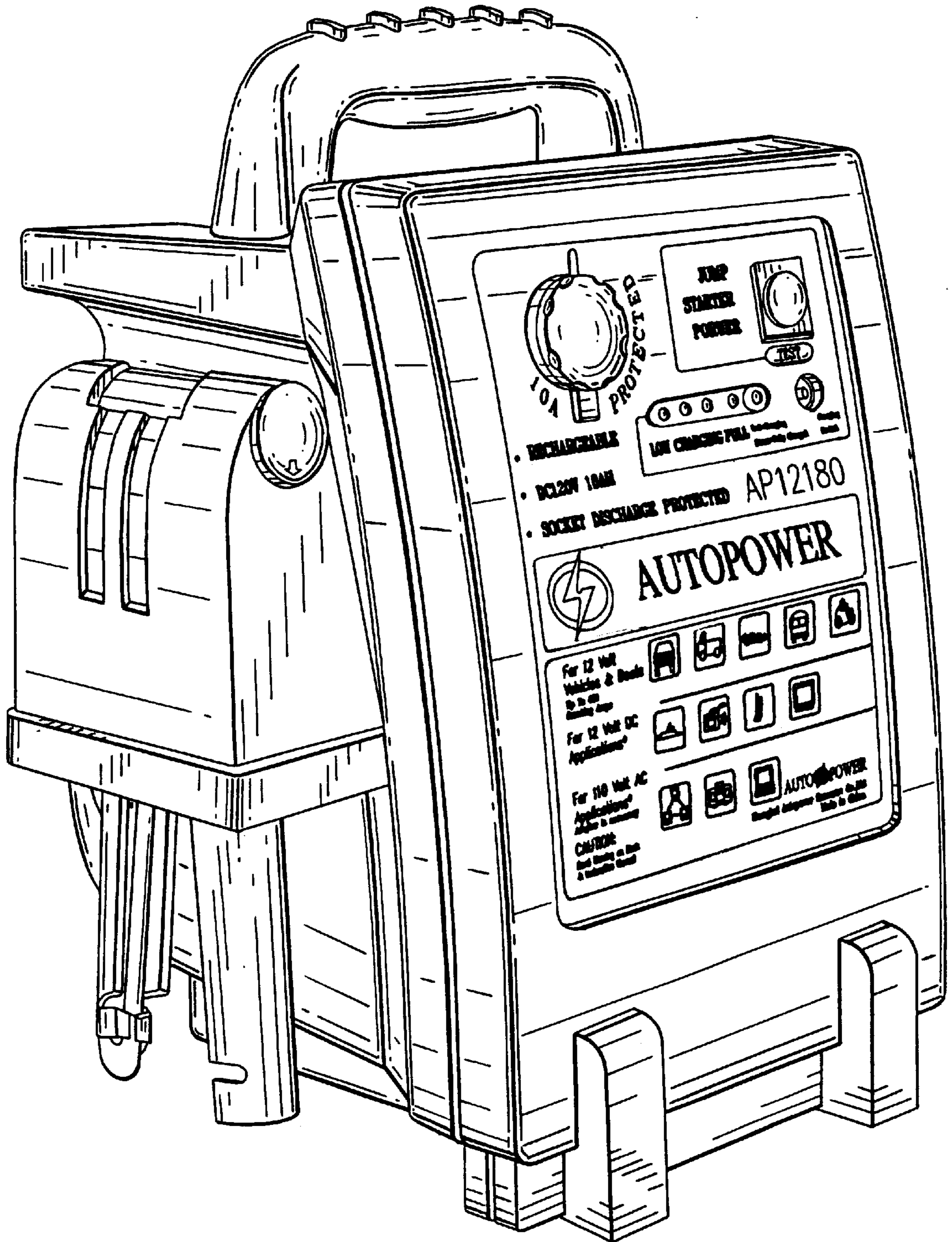

FIG. 1

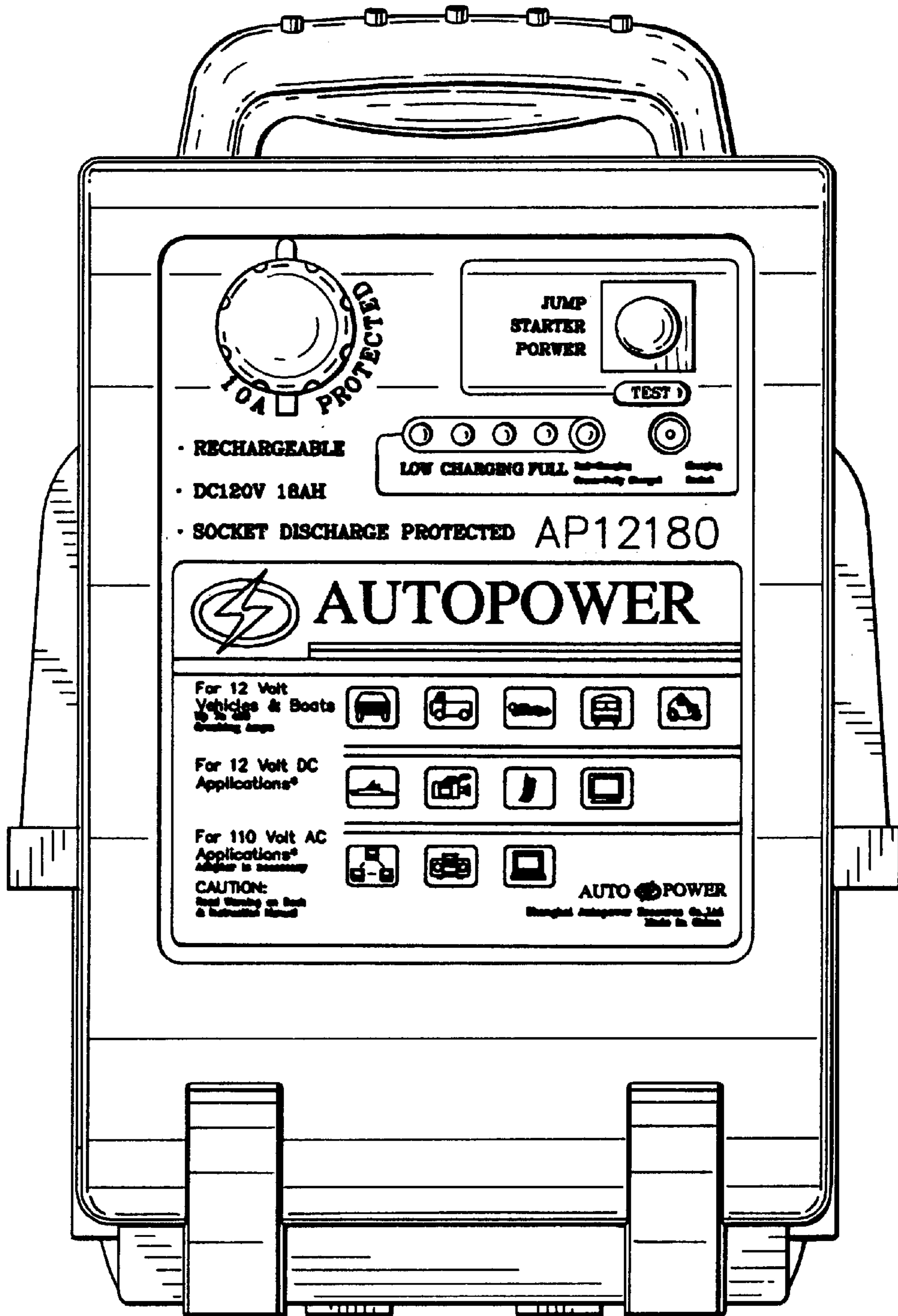

FIG. 2

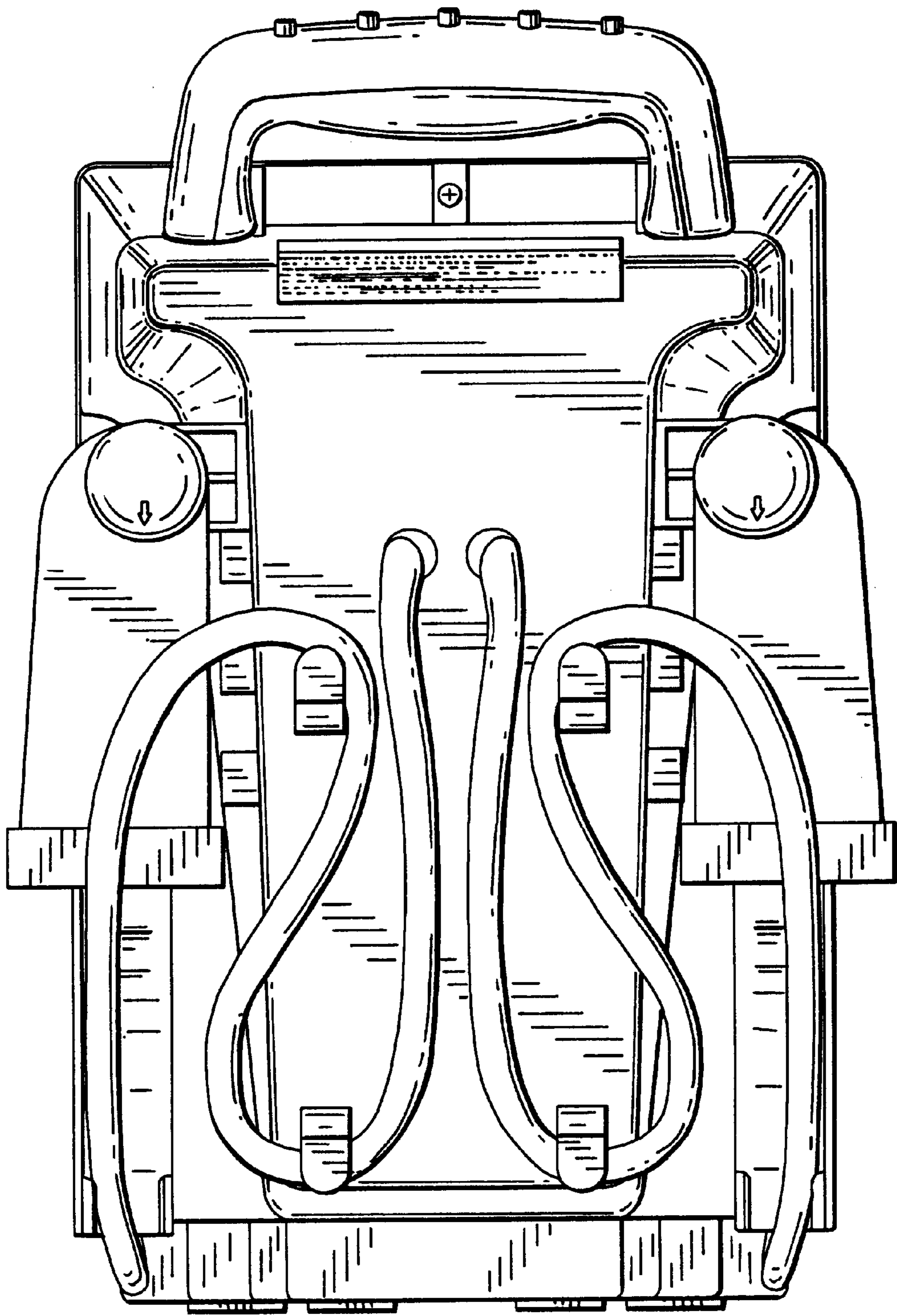

FIG. 3

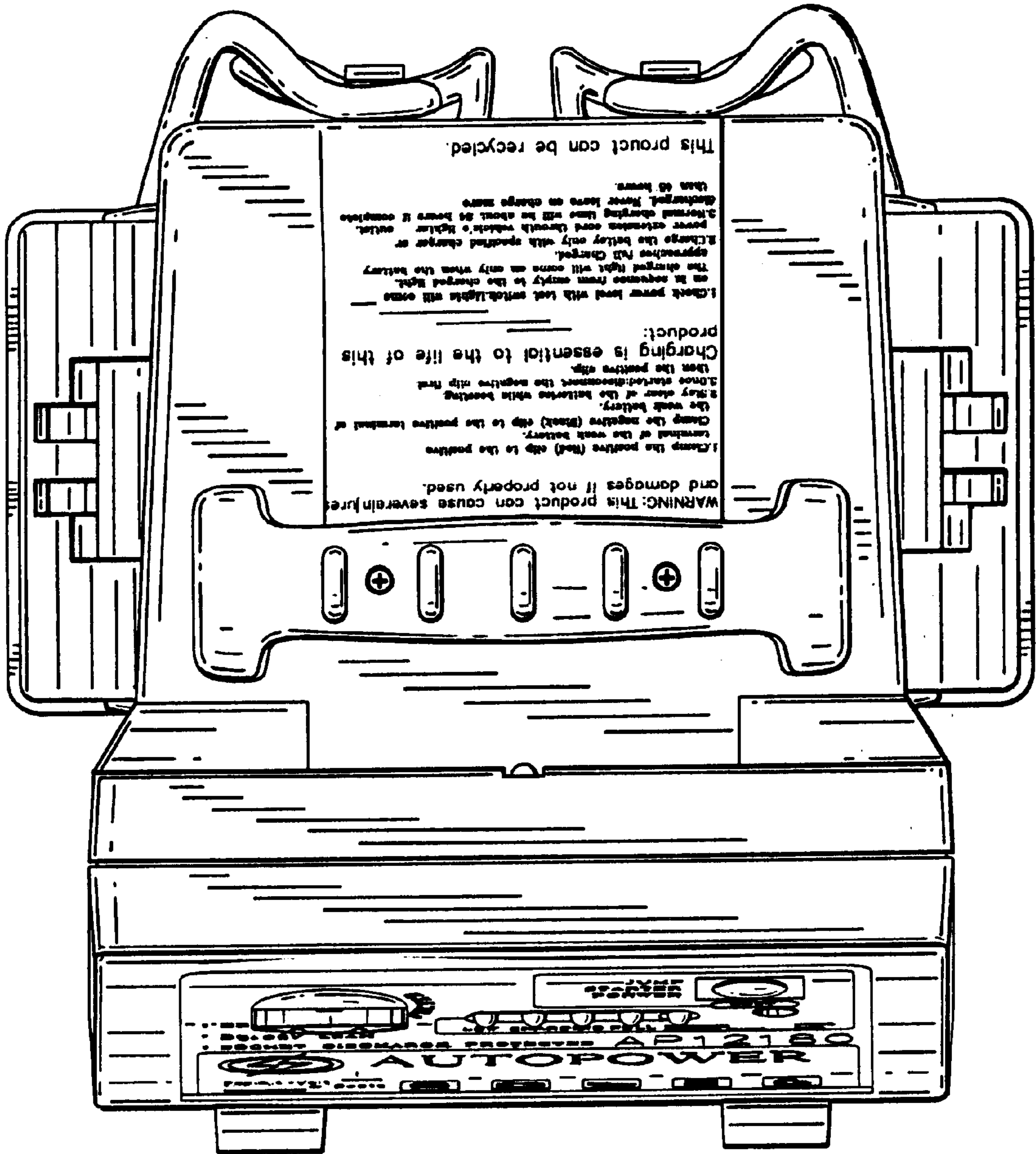

FIG. 4

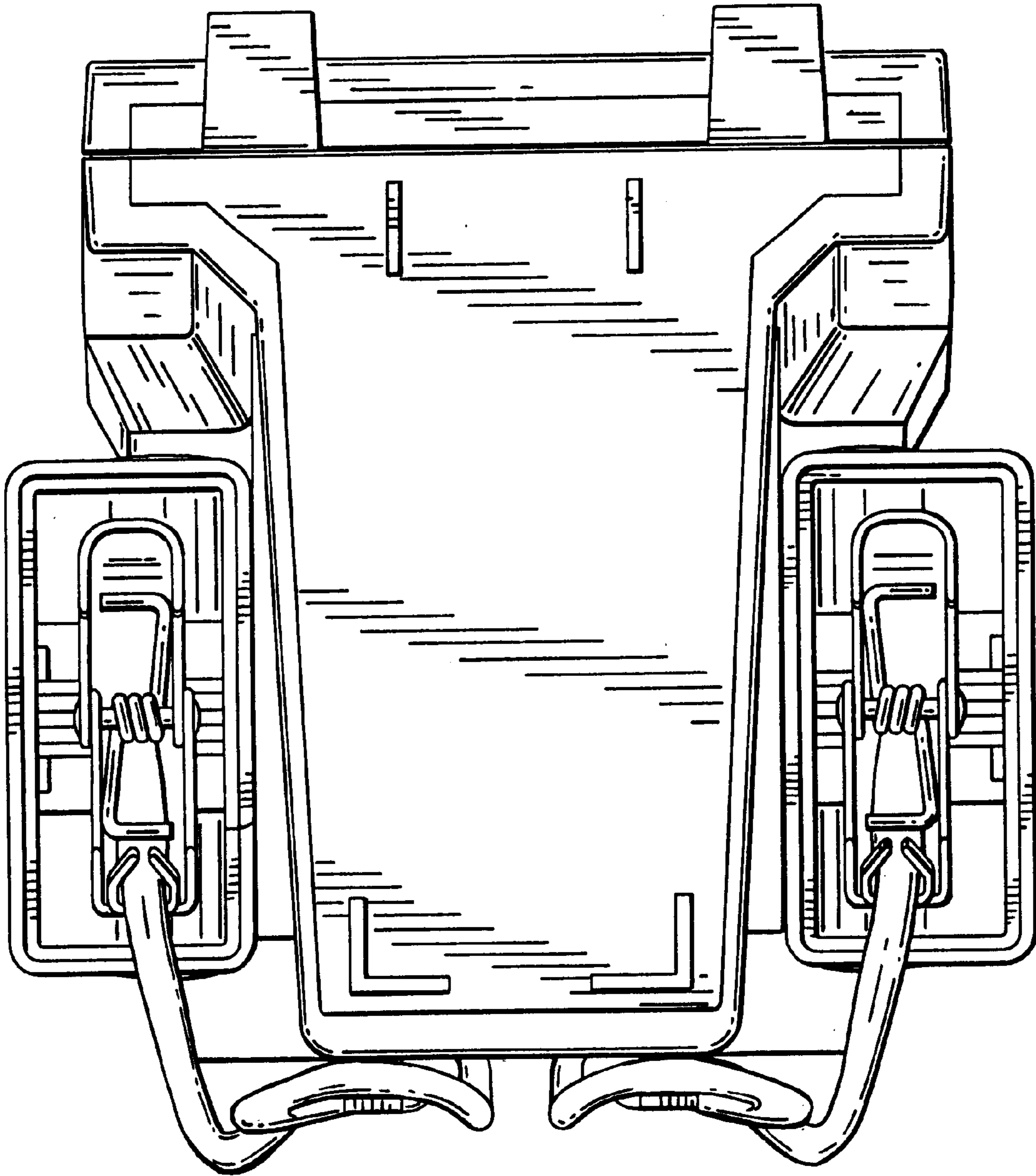

FIG. 5

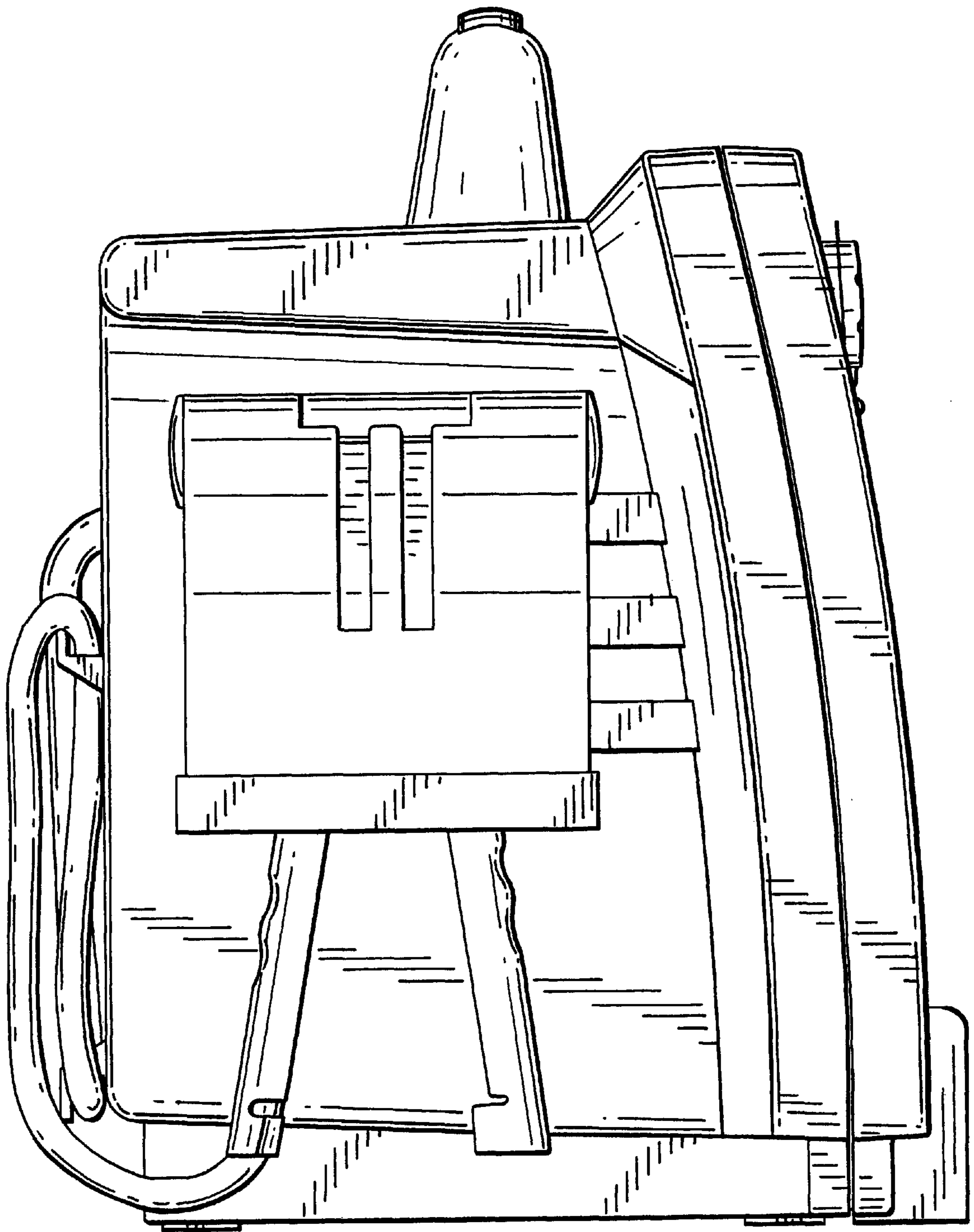

FIG. 6

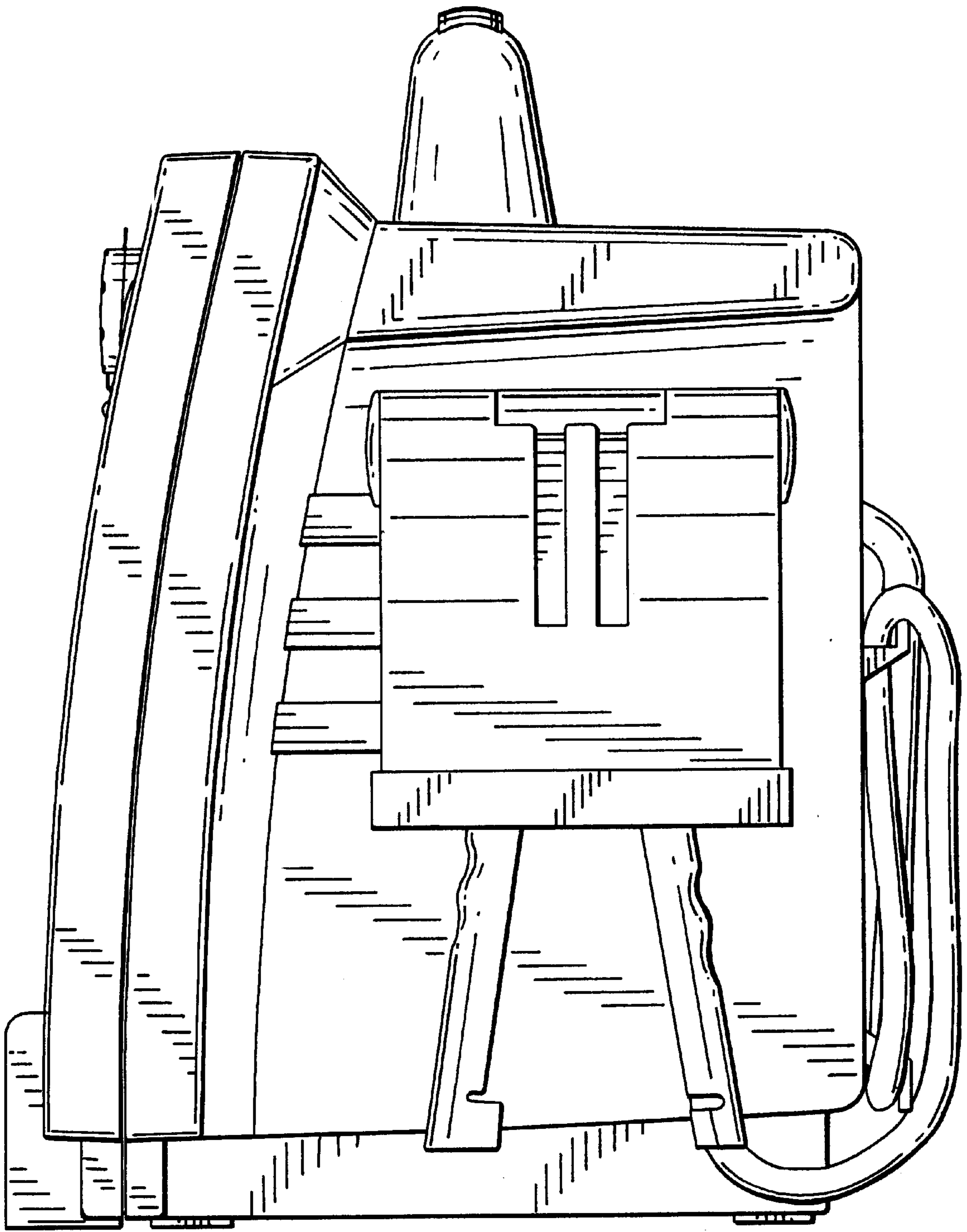

FIG. 7

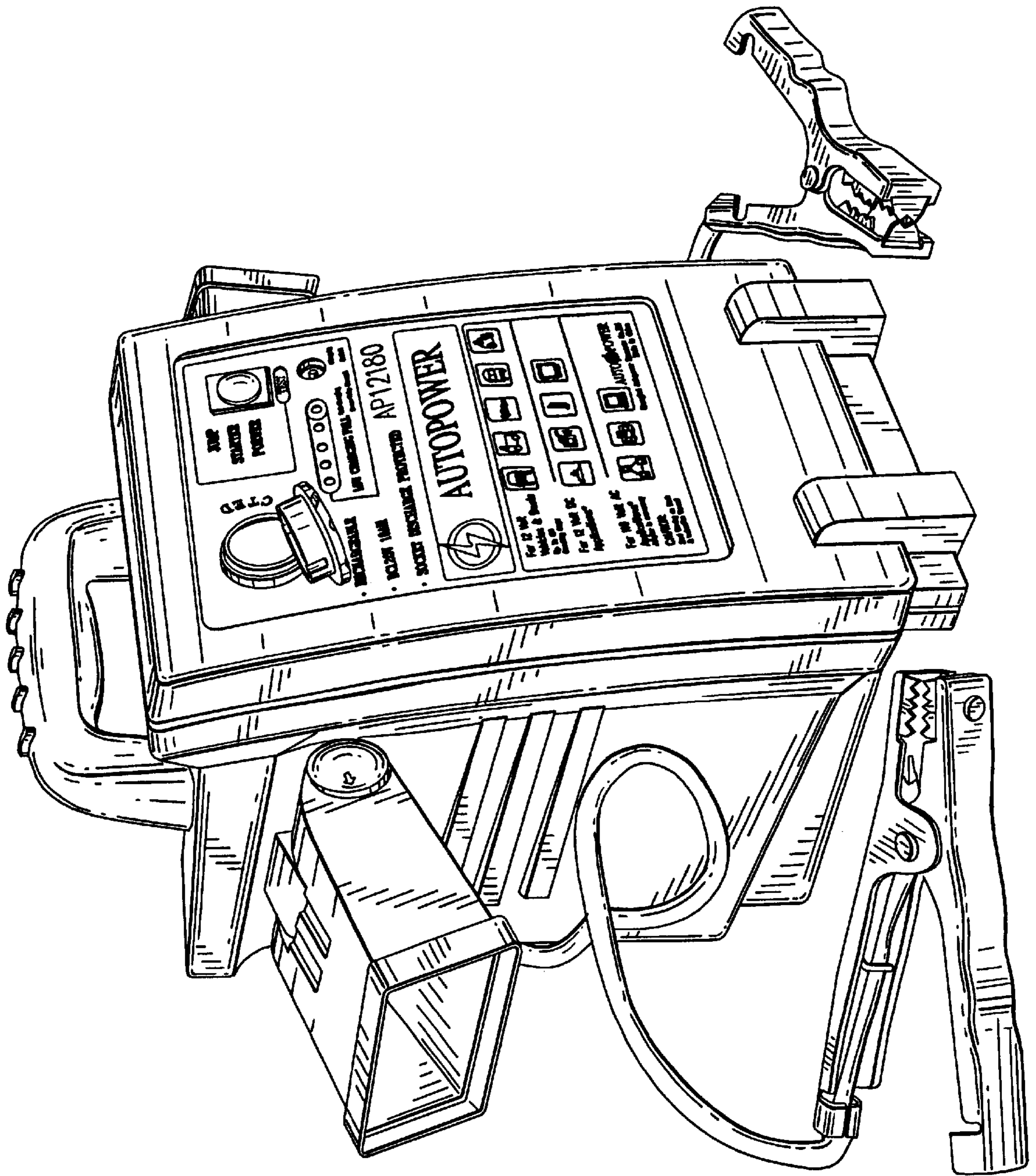

FIG. 8