



US00D448654B1

(12) **United States Design Patent**
Snell

(10) **Patent No.:** **US D448,654 S**

(45) **Date of Patent:** **** Oct. 2, 2001**

(54) **HOOK**

(75) Inventor: **Russell Benton Snell**, Bentleyville, OH (US)

(73) Assignee: **InterDesign, Inc.**

(**) Term: **14 Years**

(21) Appl. No.: **29/137,758**

(22) Filed: **Feb. 26, 2001**

(51) **LOC (7) Cl.** **08-05**

(52) **U.S. Cl.** **D8/367**

(58) **Field of Search** D8/367, 368; D6/323;
248/231.81, 339, 916, 215, 306, 205.5,
206.1, 214, 304, 206.2, 302, 303; 16/87.2;
24/369, 265 H

(56) **References Cited**

U.S. PATENT DOCUMENTS

D. 144,010	*	2/1946	VanDoren	D6/323
D. 300,003	*	2/1989	Hutchison	D8/367
2,679,998	*	1/1954	Keller	428/205
3,283,383	*	11/1966	Heath	24/457

OTHER PUBLICATIONS

“Studio Specialities” Mar. 1987, Slatwall Acrylic, Innovations 1987 Box.*

Forms and Surfaces Brochure, Nov. 13, 1986.*

* cited by examiner

Primary Examiner—Pamela Burgess

(74) *Attorney, Agent, or Firm*—D. Peter Hochberg; Katherine R. Vieyra; William H. Holt

(57) **CLAIM**

The ornamental design for a hook, as shown and described.

DESCRIPTION

FIG. 1 is a perspective view of the hook according to the invention;

FIG. 2 is a top view of the hook as shown in FIG. 1;

FIG. 3 is a side view of the hook as shown in FIG. 1;

FIG. 4 is a front view of the hook as shown in FIG. 1;

FIG. 5 is a side view as shown in FIG. 1, viewed from the opposite side from that shown in FIG. 3;

FIG. 6 is a rear view of the hook as shown in FIG. 1; and,

FIG. 7 is a bottom view of the hook as shown in FIG. 1.

1 Claim, 2 Drawing Sheets

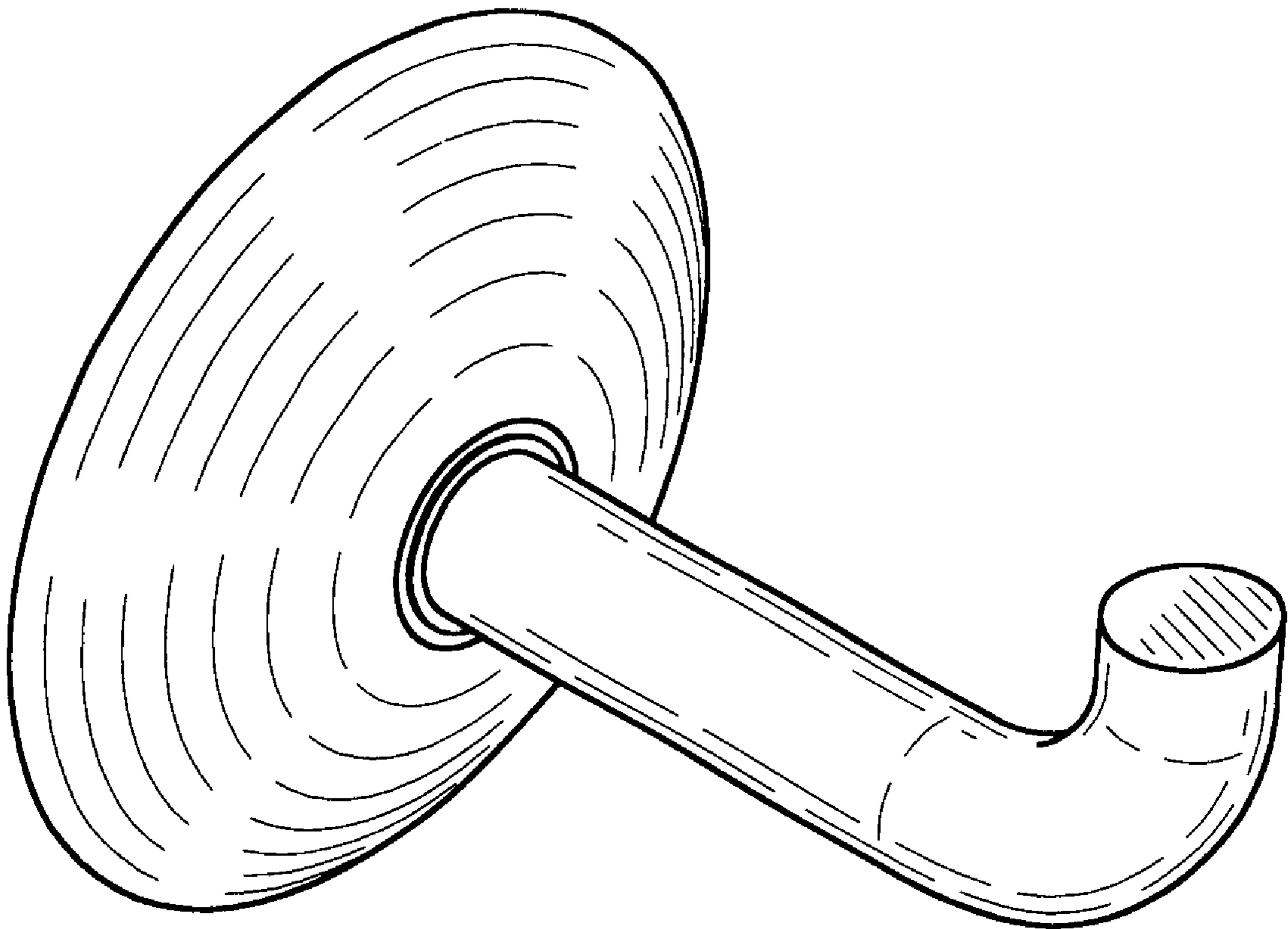

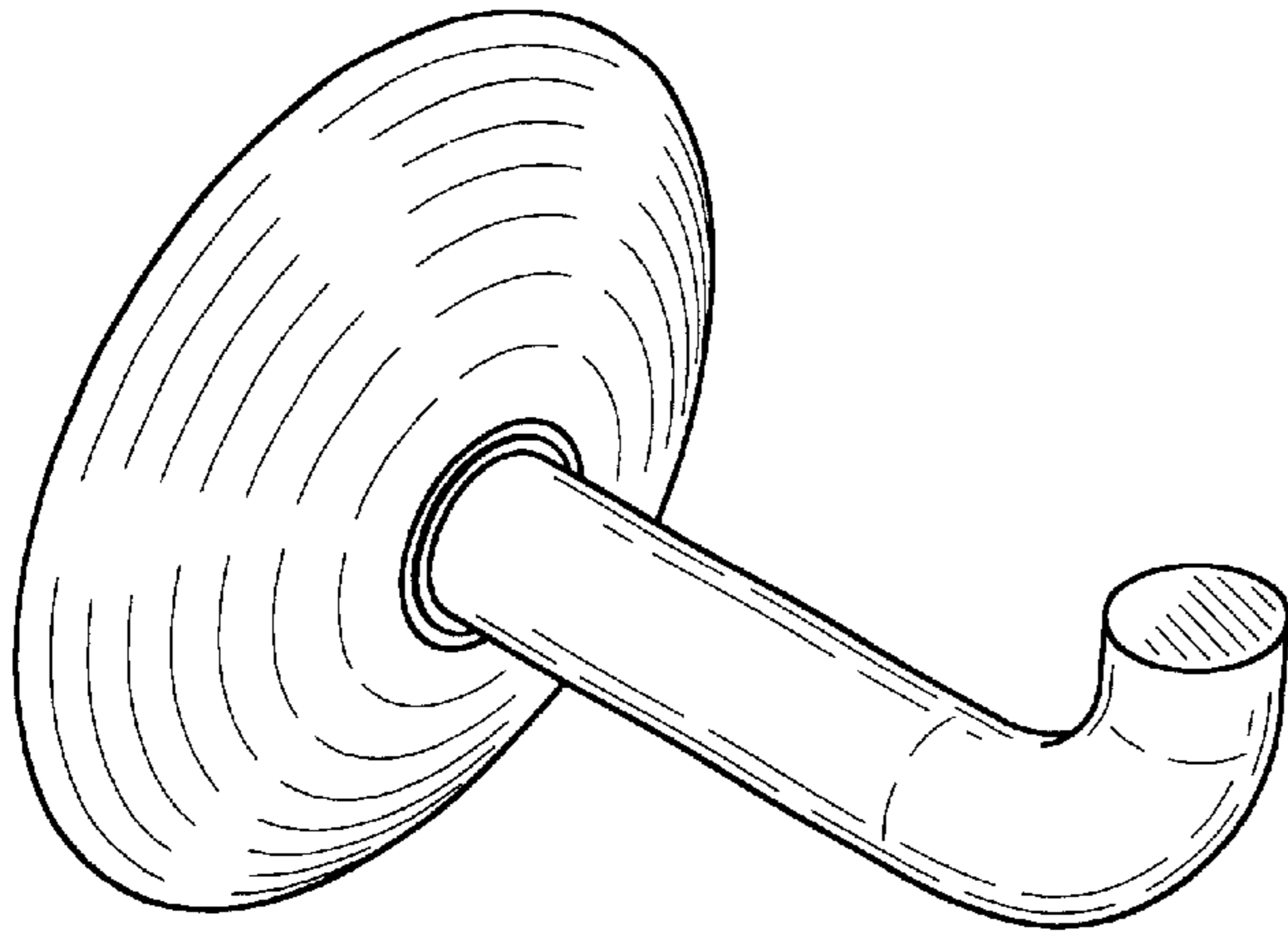

FIG-1

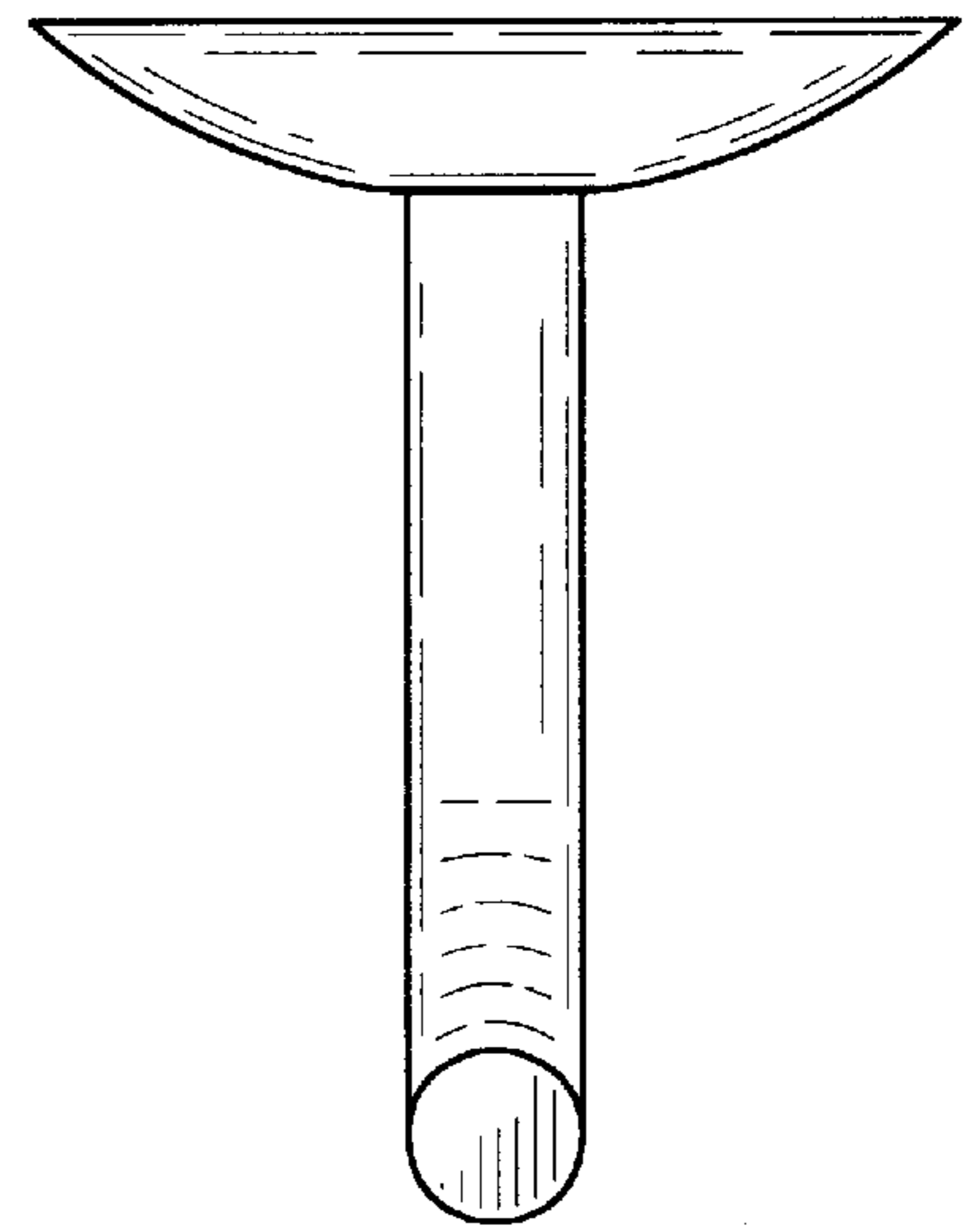

FIG-2

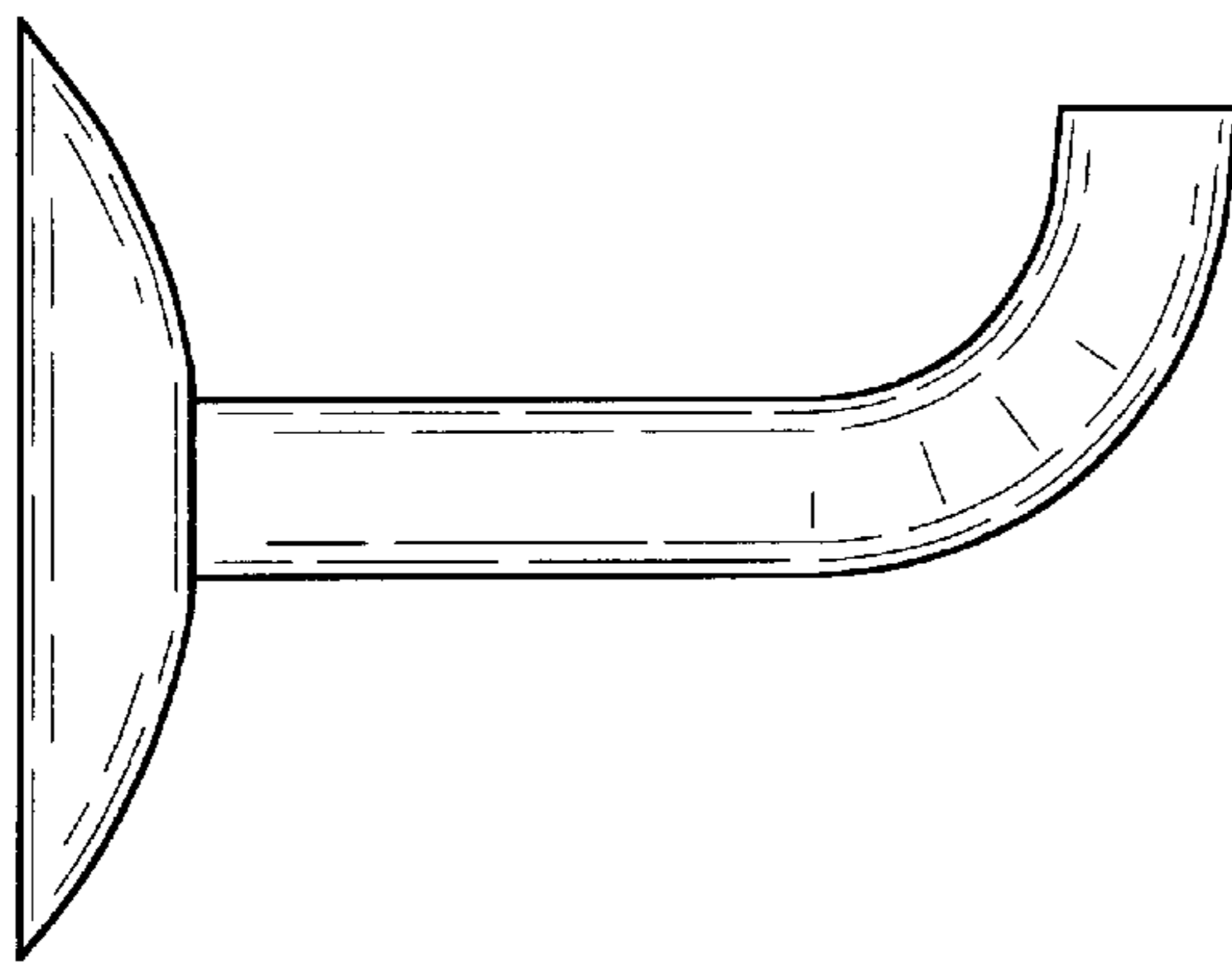

FIG-3

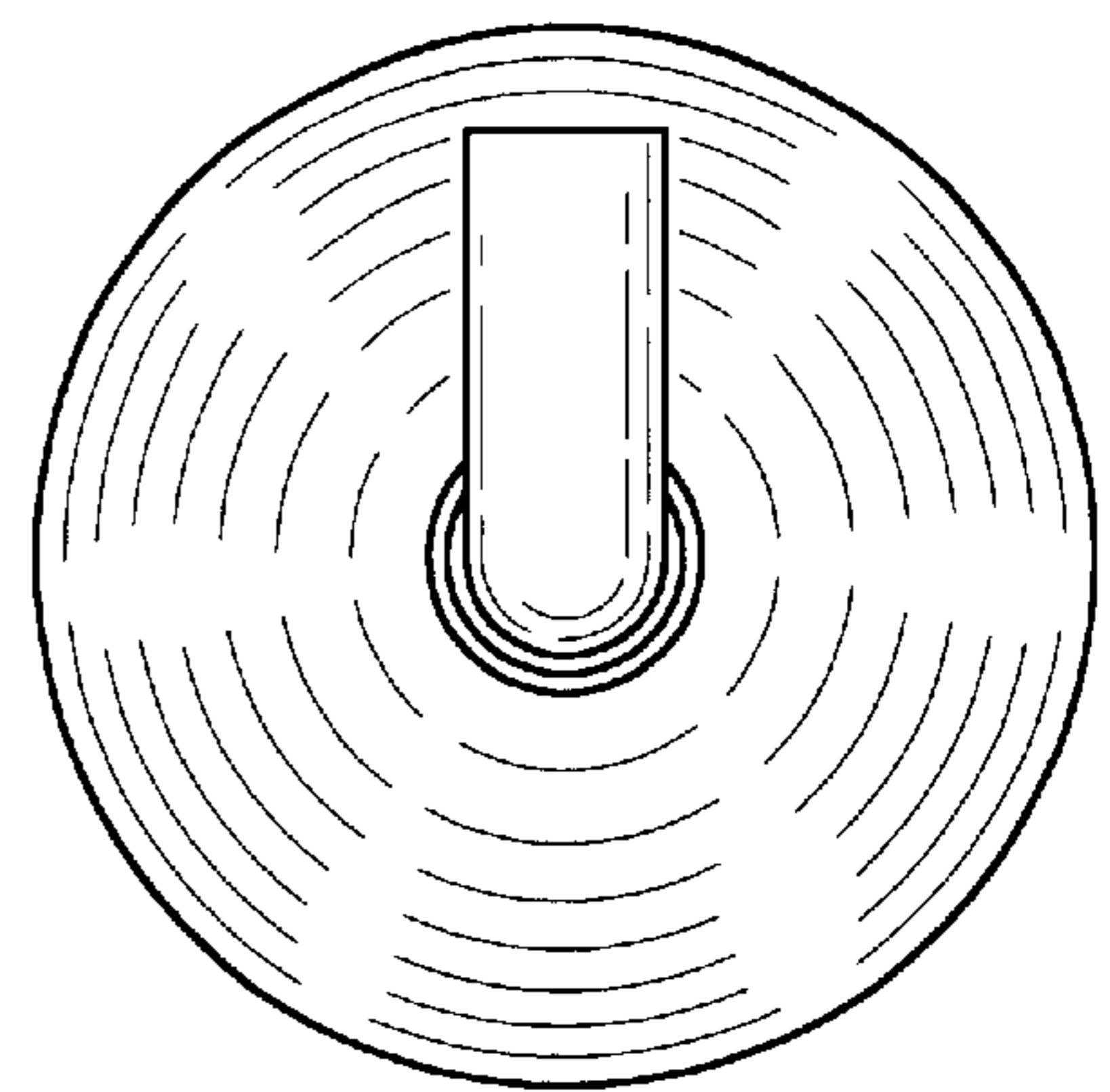

FIG-4

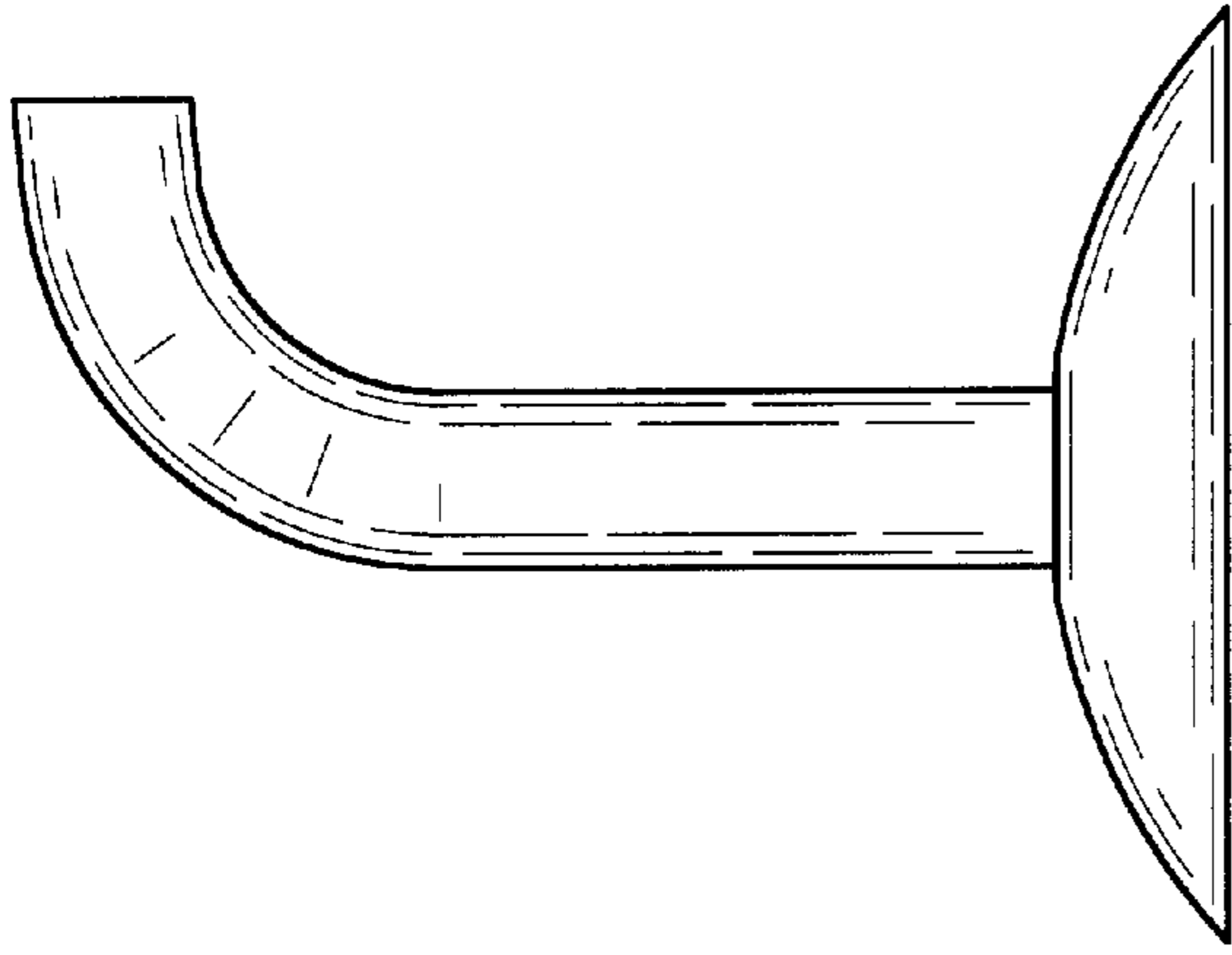

FIG-5

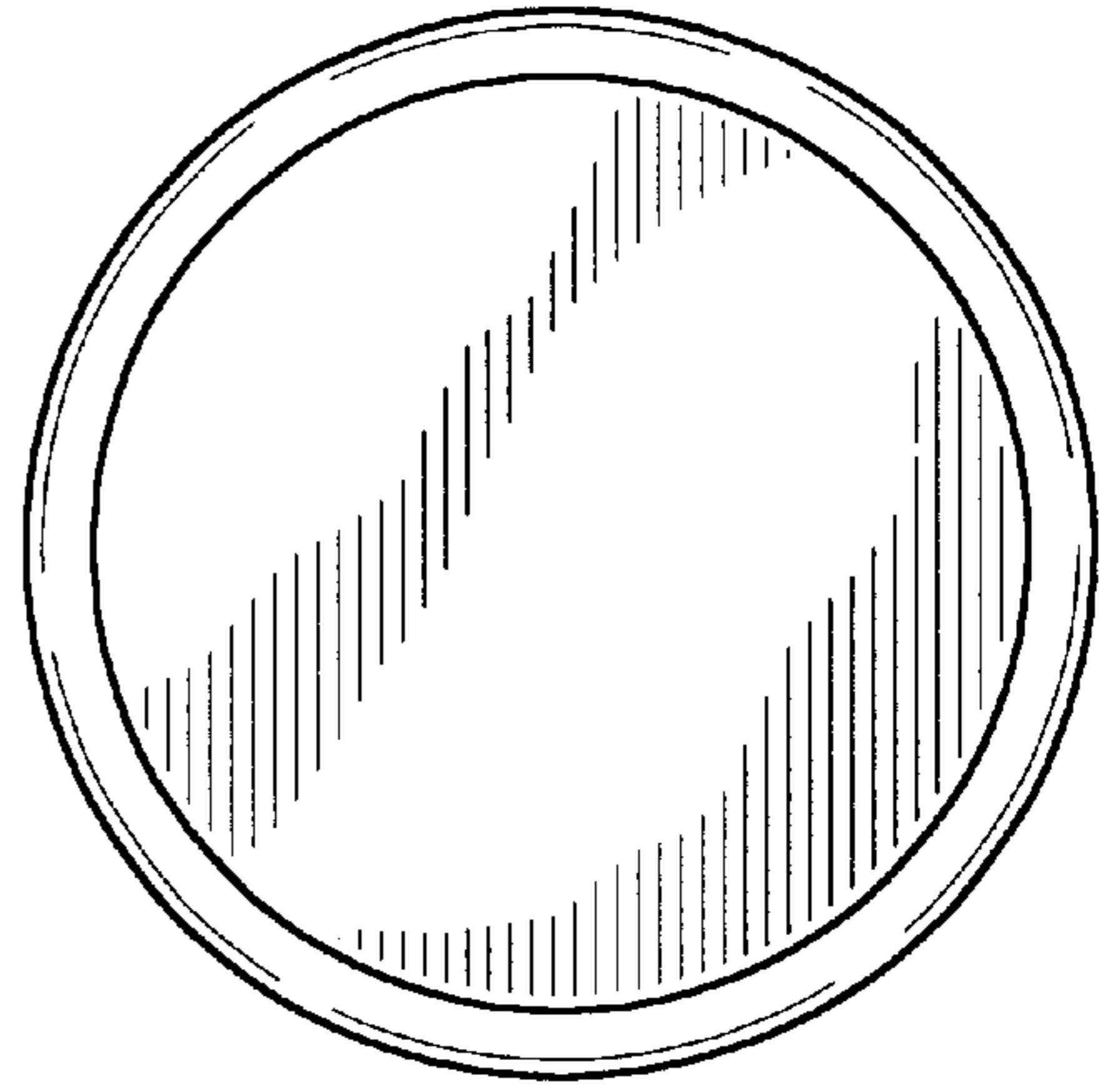

FIG-6

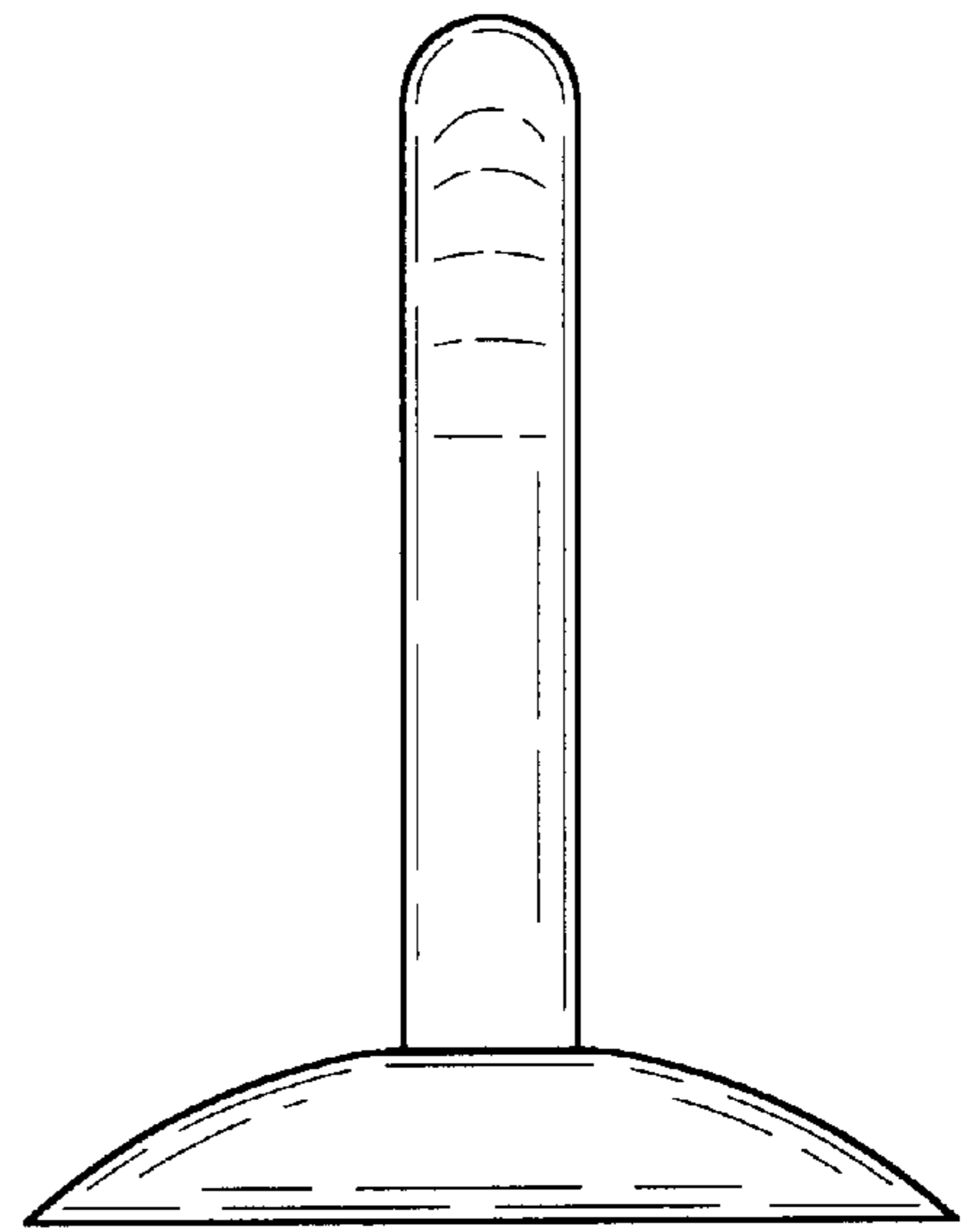

FIG-7