



US00D448537B1

(12) **United States Design Patent**  
**Harrah**

(10) **Patent No.:** **US D448,537 S**

(45) **Date of Patent:** **\*\* Sep. 25, 2001**

(54) **WINCH JACK ATTACHMENT BRACKET**

(75) Inventor: **Eric A. Harrah**, Bloomfield, IN (US)

(73) Assignee: **Bloomfield Manufacturing Company, Inc.**, Bloomfield, IN (US)

(\*\*) Term: **14 Years**

(21) Appl. No.: **29/126,209**

(22) Filed: **Jul. 11, 2000**

(51) **LOC (7) Cl.** ..... **12-05**

(52) **U.S. Cl.** ..... **D34/35**

(58) **Field of Search** ..... D34/28, 35, 31,  
D34/33; D8/355, 360, 356; 294/1.1; 254/409;  
403/79; 410/101

(56) **References Cited**

**U.S. PATENT DOCUMENTS**

D. 25,778	*	7/1896	Bates	.....	D34/35
D. 27,812	*	11/1897	Foote	.....	D34/35
D. 33,376	*	10/1900	Paulson	.....	D34/35
D. 193,943	*	10/1962	Gray	.....	D34/33
D. 265,173	*	6/1982	Brooks	.....	D8/356
D. 417,328	*	11/1999	Kwon	.....	D34/35

**OTHER PUBLICATIONS**

3 Polaroid photographs of a packaged device entitled "Bumper Lift".

\* cited by examiner

*Primary Examiner*—Cynthia E. Ramirez

(74) *Attorney, Agent, or Firm*—Woodard, Emhardt, Naughton, Moriarty & McNett

(57) **CLAIM**

The ornamental design for a winch jack attachment bracket, as shown and described.

**DESCRIPTION**

FIG. 1 is a perspective view of the winch jack attachment bracket of the present invention.

FIG. 2 is a top plan view.

FIG. 3 is a bottom plan view.

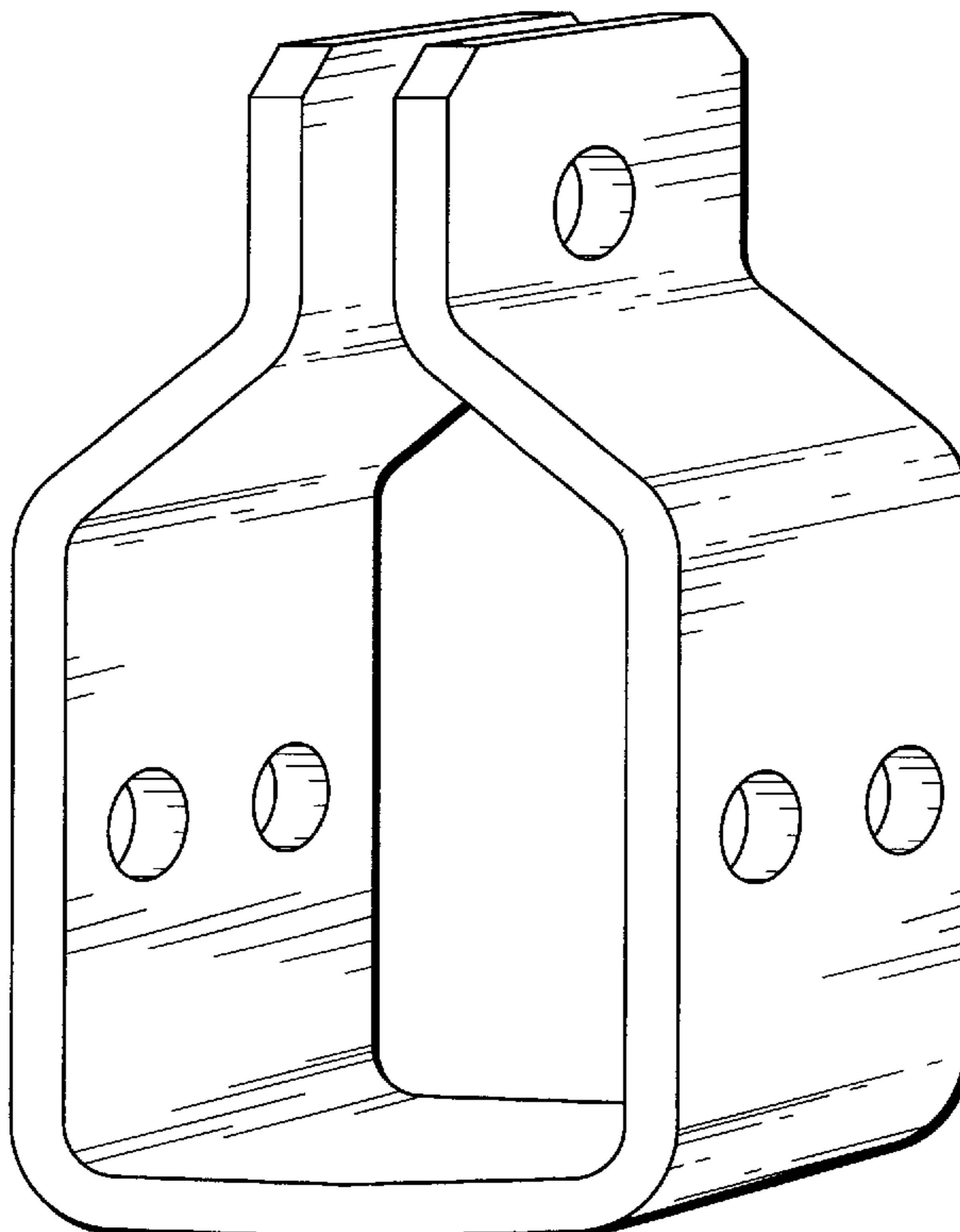
FIG. 4 is a front elevation. The rear elevation is identical to the front elevation.

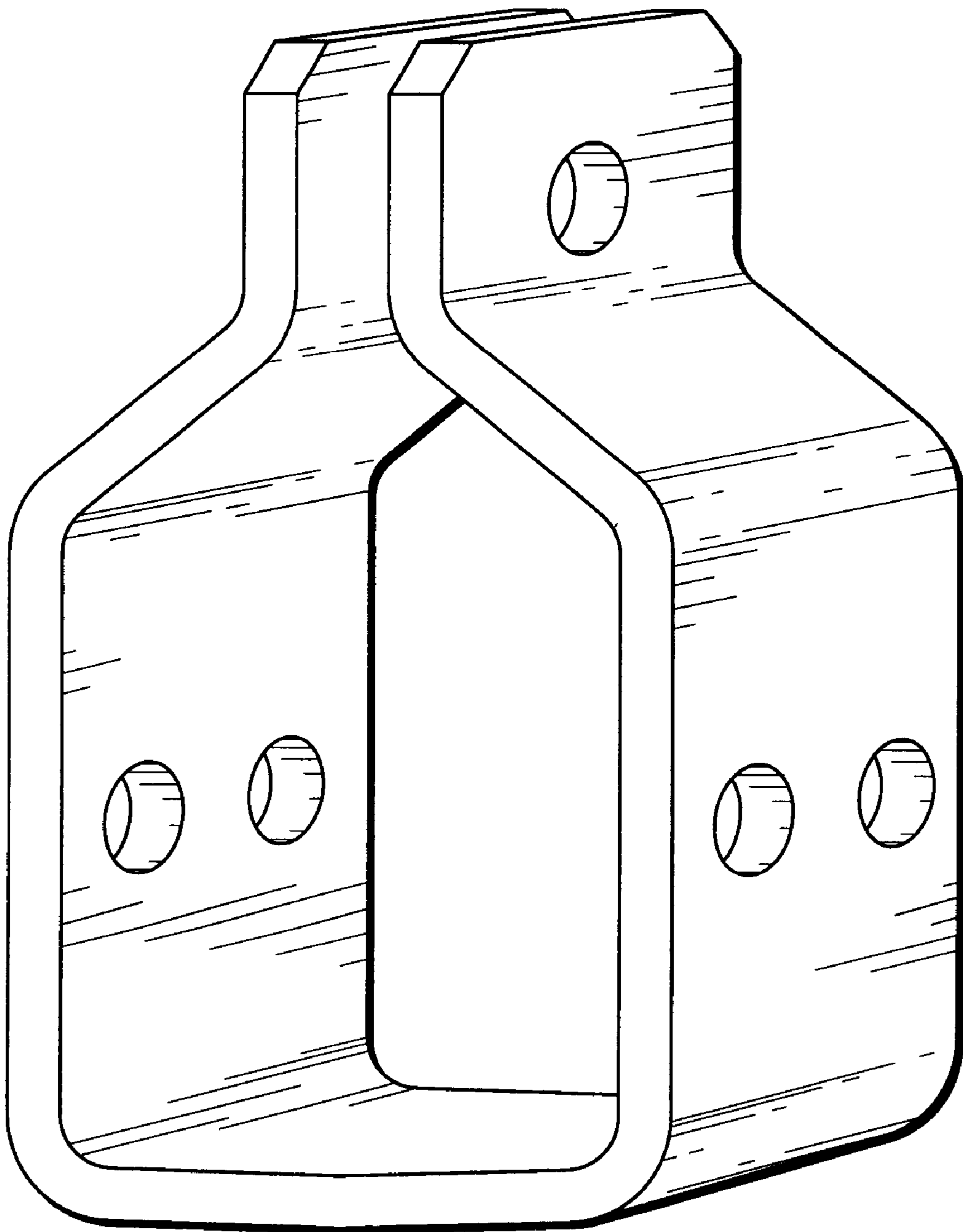
FIG. 5 is a side elevation taken from the right side of FIG. 4. The side elevation taken from the left side of FIG. 4 is identical to FIG. 5; and,

FIG. 6 is a perspective view showing environment of the present invention.

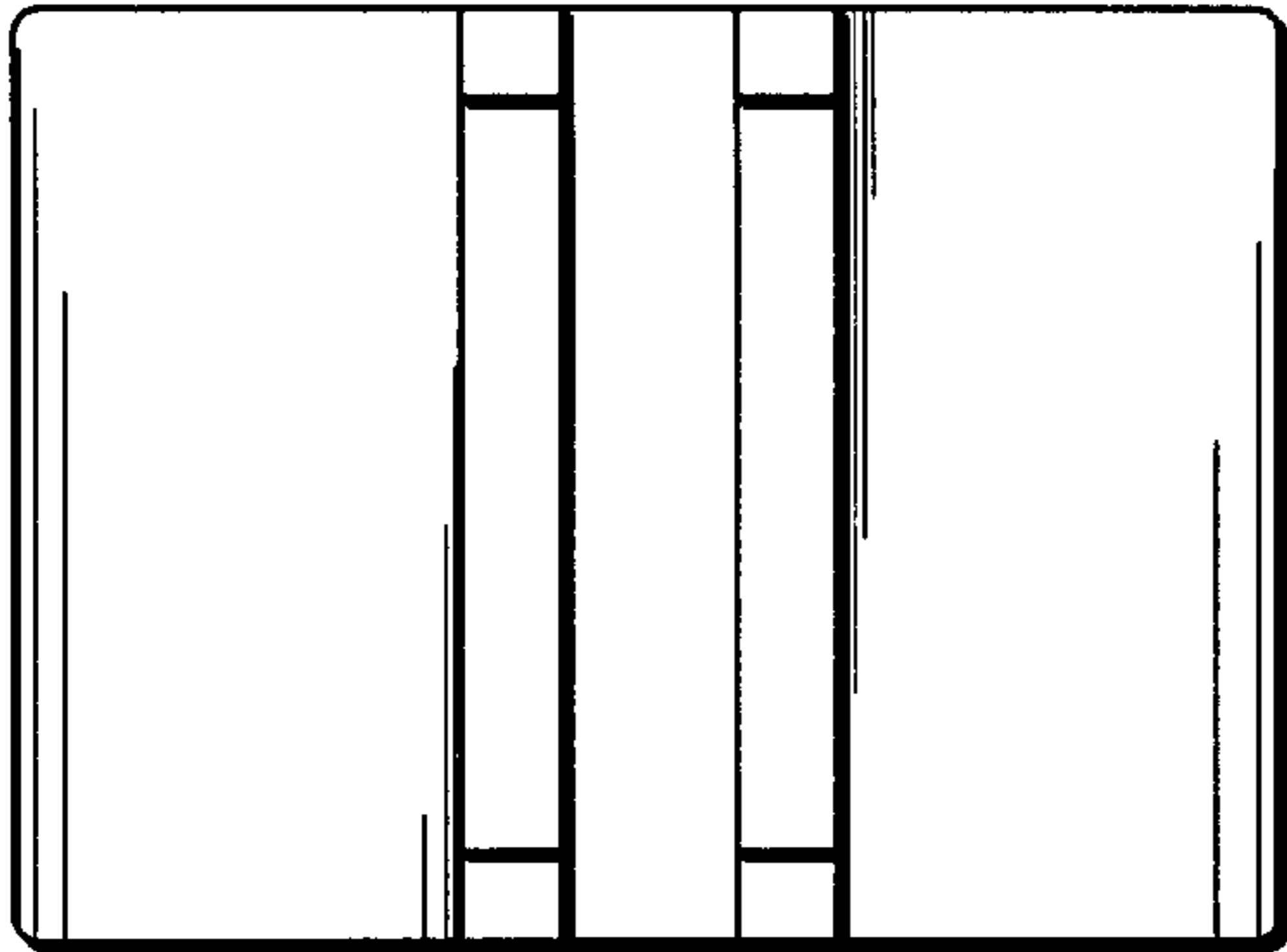
The broken line showing of a chain and hardware in FIG. 6 is for illustrative purposes only and forms no part of the claimed design.

**1 Claim, 3 Drawing Sheets**

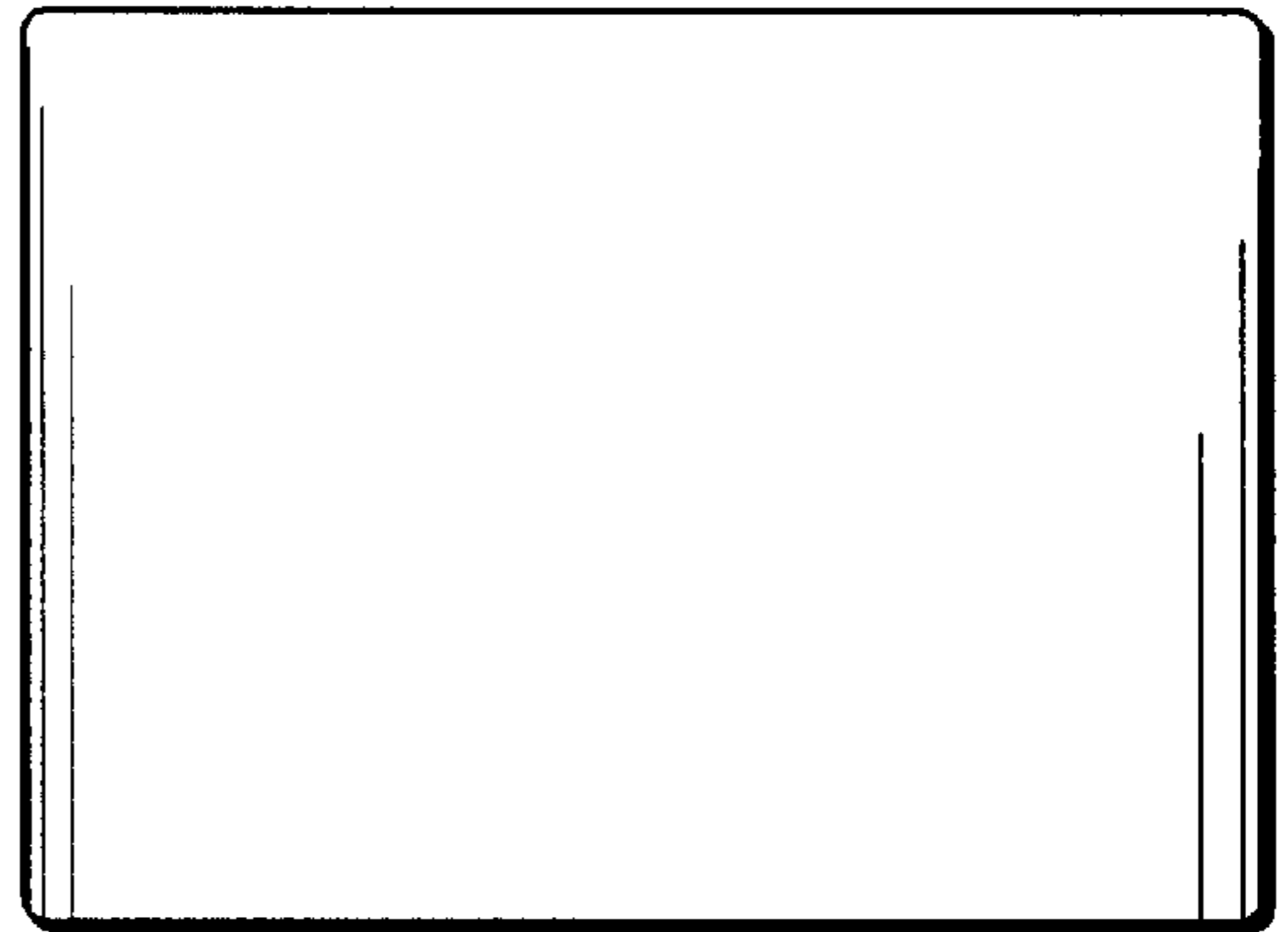




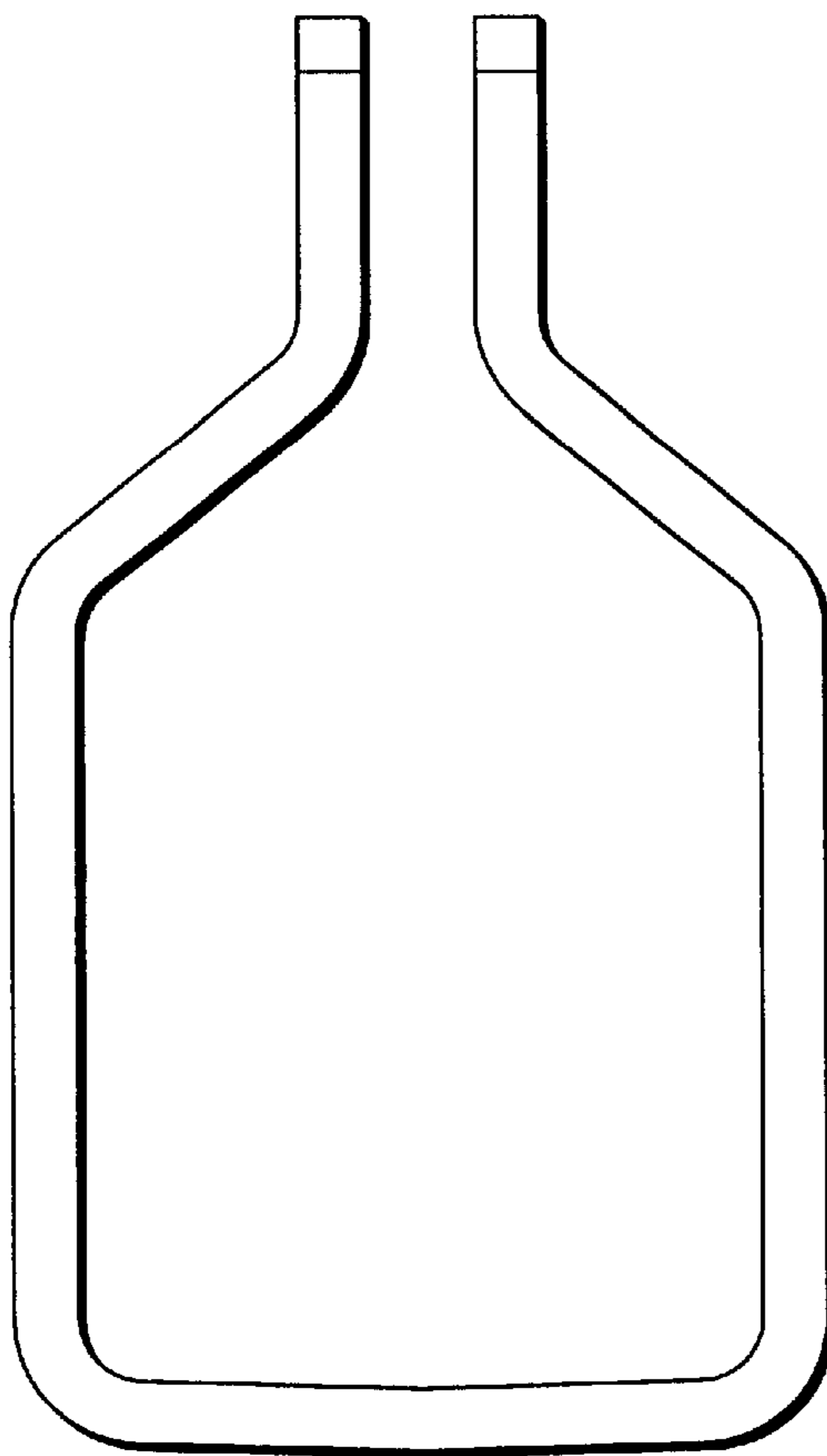
***Fig. 1***



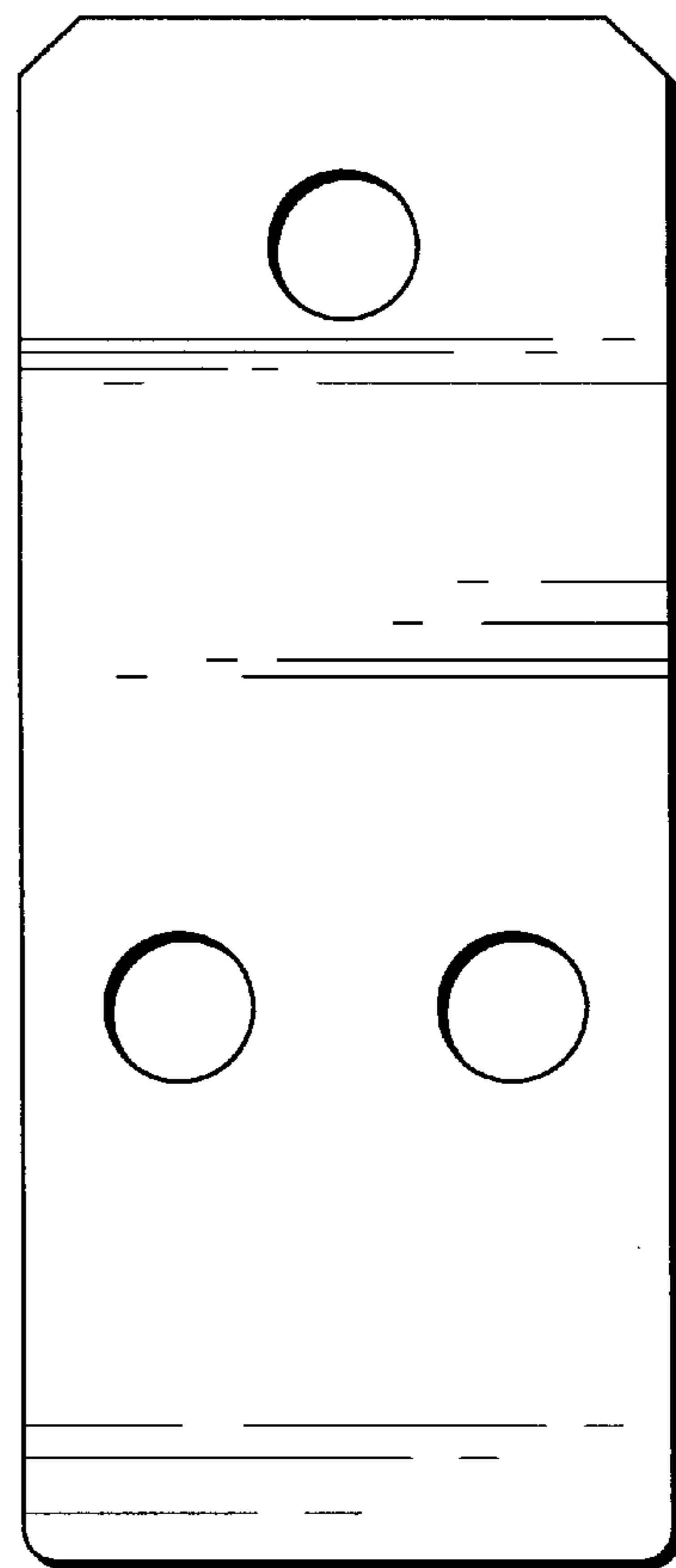
**Fig. 2**



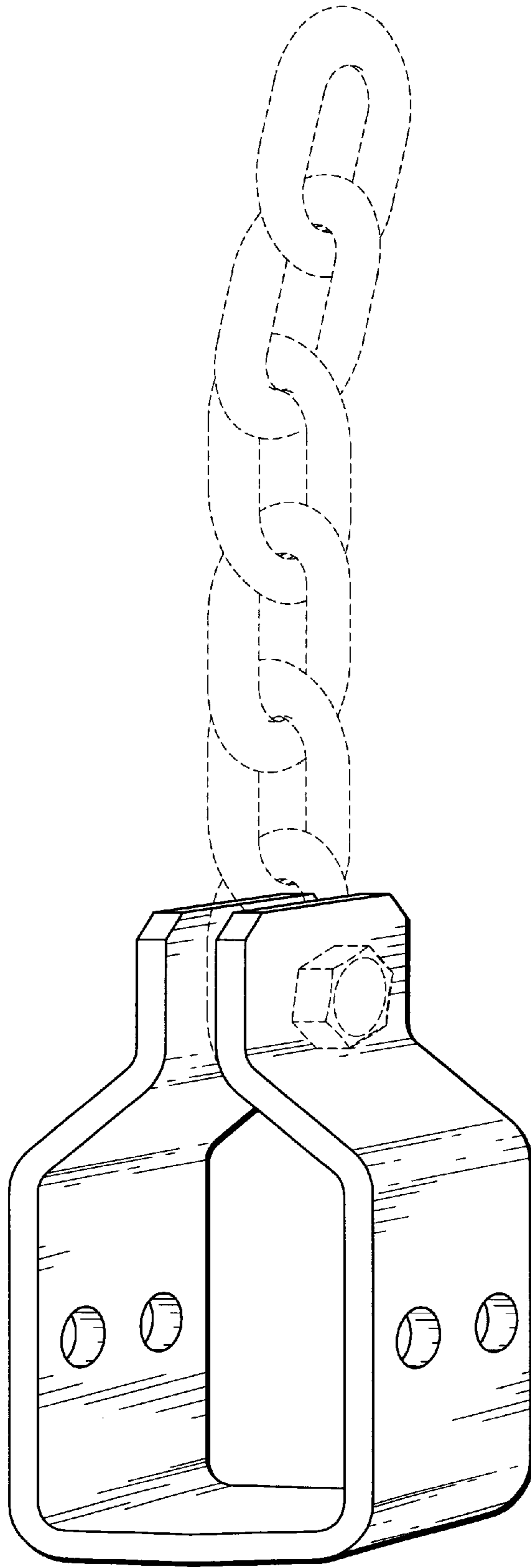
**Fig. 3**



**Fig. 4**



**Fig. 5**



**Fig. 6**