



US00D448372B1

(12) **United States Design Patent**
Kim

(10) **Patent No.:** **US D448,372 S**

(45) **Date of Patent:** **** Sep. 25, 2001**

(54) **MULTIMEDIA COMPUTER**

(75) **Inventor:** **Yong-Nam Kim, Seongnam (KR)**

(73) **Assignee:** **UM Digital, Inc., Seoul (KR)**

(**) **Term:** **14 Years**

(21) **Appl. No.:** **29/131,983**

(22) **Filed:** **Oct. 30, 2000**

(30) **Foreign Application Priority Data**

Oct. 12, 2000 (KR) 2000-26012

(51) **LOC (7) Cl.** **14-02**

(52) **U.S. Cl.** **D14/337; D14/172**

(58) **Field of Search** D14/300, 301,
D14/314, 336, 337, 126-129, 305-307,
331, 373; 345/104, 156, 168, 169, 173,
133; 348/180, 184, 325, 739; 341/12; 349/1,
2, 11, 62

(56) **References Cited**

U.S. PATENT DOCUMENTS

- D. 273,867 * 5/1984 Sanders et al. D14/336
- D. 360,193 * 7/1995 Franzen D14/331
- D. 369,790 * 5/1996 Kim D14/379
- D. 370,466 * 6/1996 Vossoughi D14/336
- D. 372,226 * 7/1996 Maguire, Jr. D14/306
- D. 397,324 * 8/1998 Minemoto et al. D14/337

- D. 424,530 * 5/2000 Kurtz et al. D14/336
- D. 431,547 * 10/2000 Mirone D14/168
- D. 433,008 * 10/2000 Pardo D14/168
- 5,687,939 * 11/1997 Moscovitch 248/122.1

* cited by examiner

Primary Examiner—Freda Nunn

(74) *Attorney, Agent, or Firm*—Christie, Parker & Hale, LLP

(57) **CLAIM**

The ornamental design for a multimedia computer, as shown and described.

DESCRIPTION

FIG. 1 is a front elevational view of the design for a multimedia computer;
 FIG. 2 is a rear elevational view of the design of FIG. 1;
 FIG. 3 is a left side elevational view of the design of FIG. 1;
 FIG. 4 is a right side elevational view of the design of FIG. 1;
 FIG. 5 is a top plan view of the design of FIG. 1;
 FIG. 6 is a bottom plan view of the design of FIG. 1; and,
 FIG. 7 is a top, front, right side perspective view of the design of FIG. 1.

The surface(s) or portion(s) of the article not shown in the drawing or described in the specification form(s) no part of the claimed design.

1 Claim, 4 Drawing Sheets

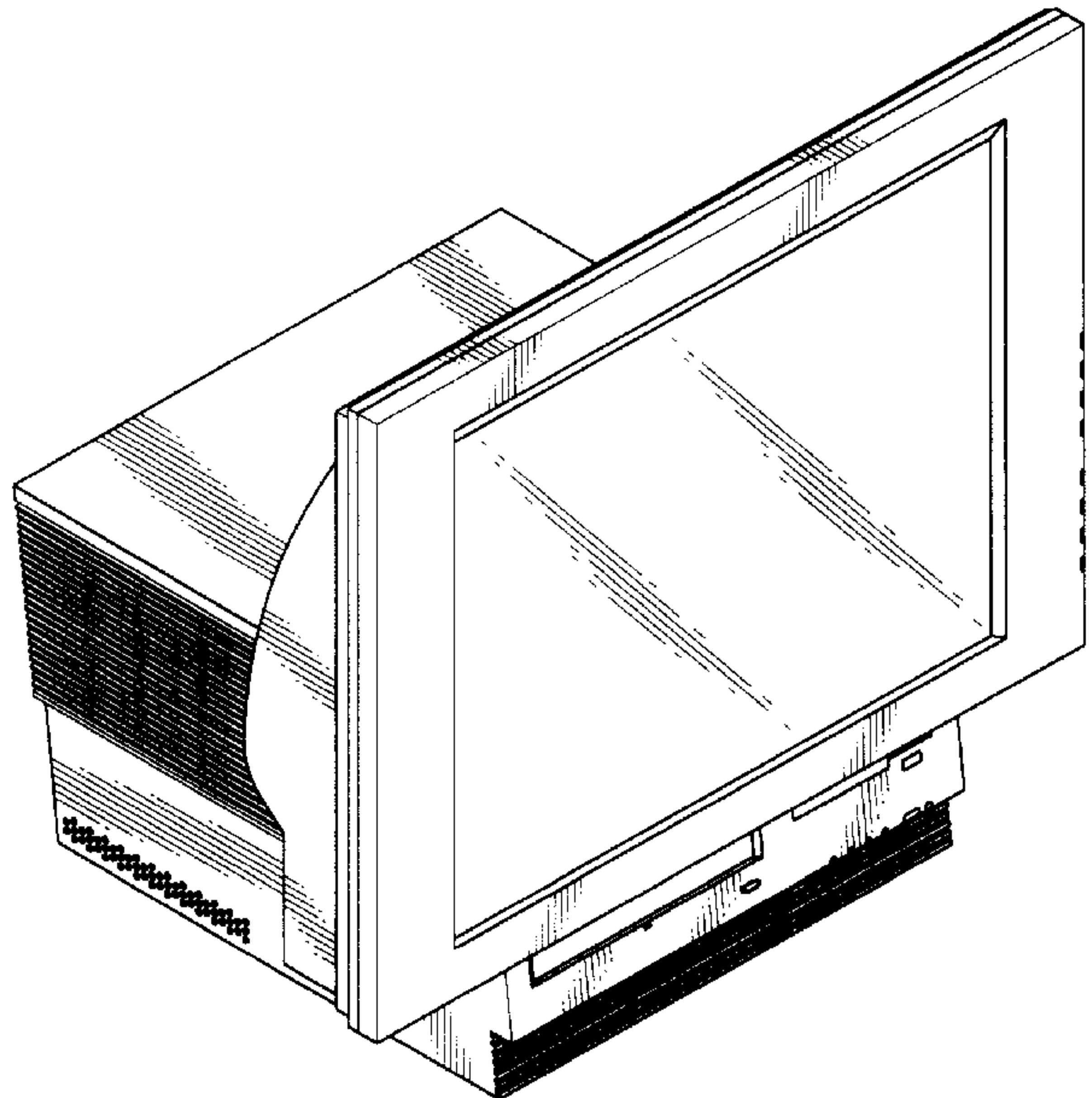
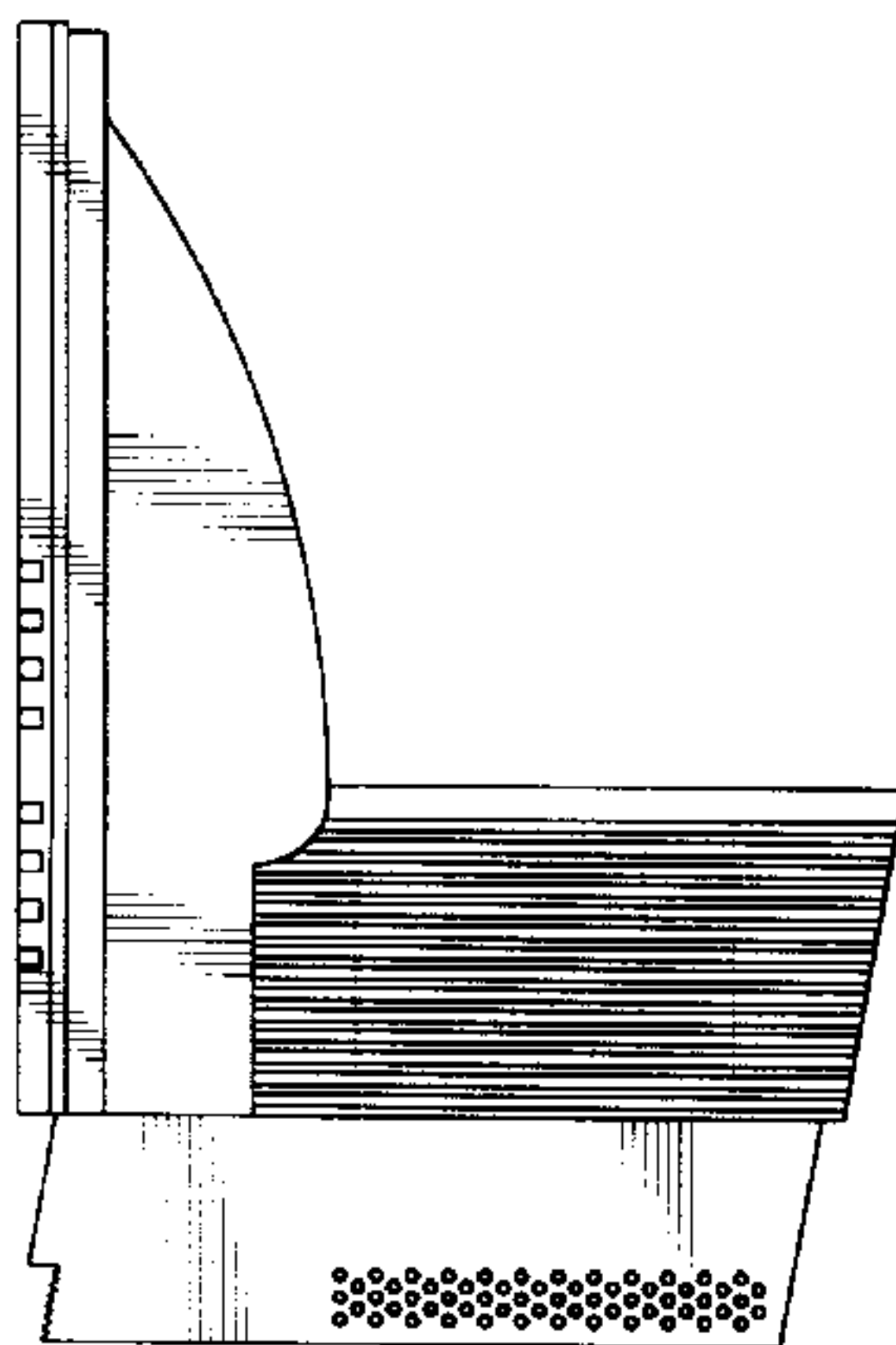

FIG.1

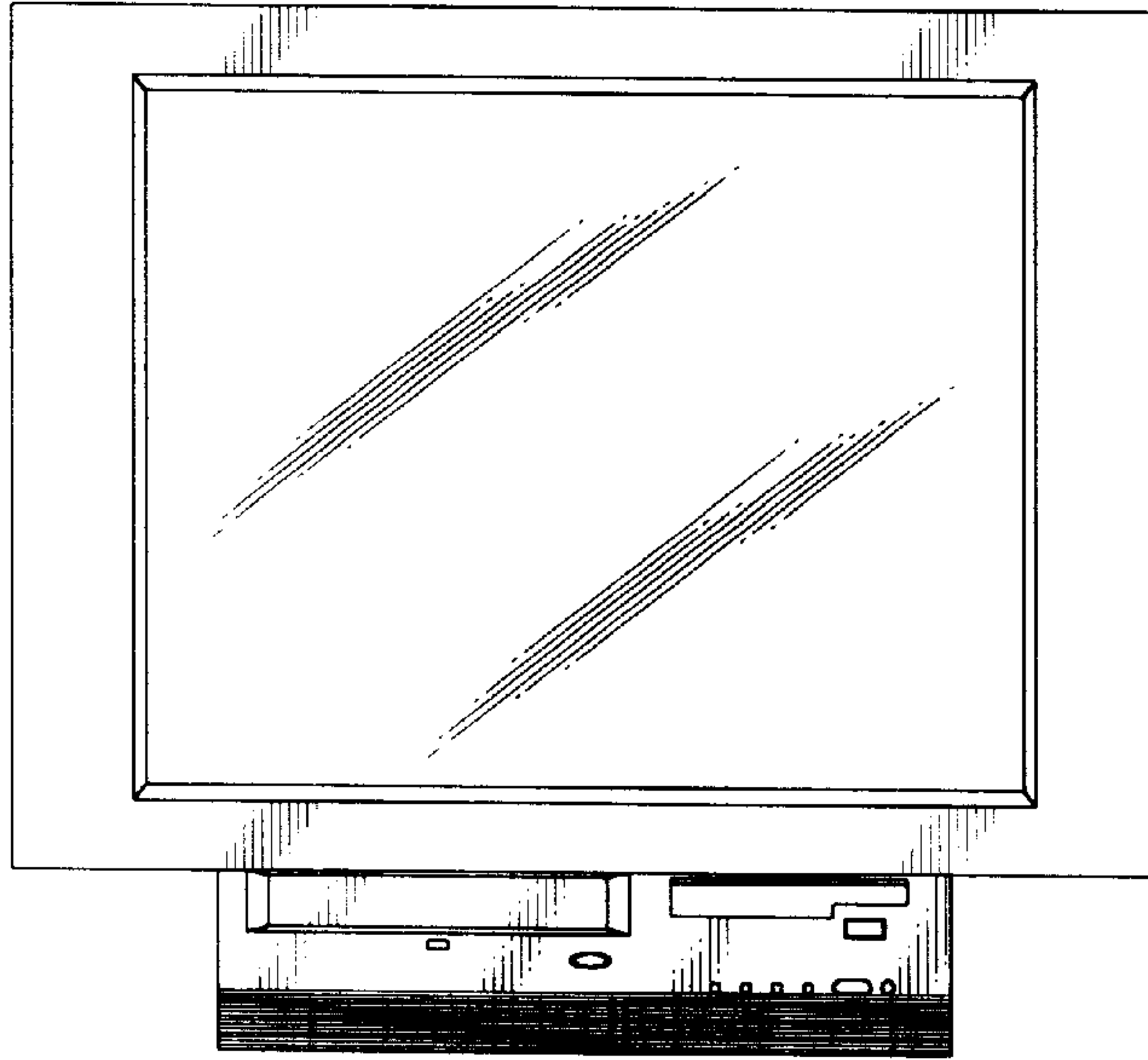

FIG.2

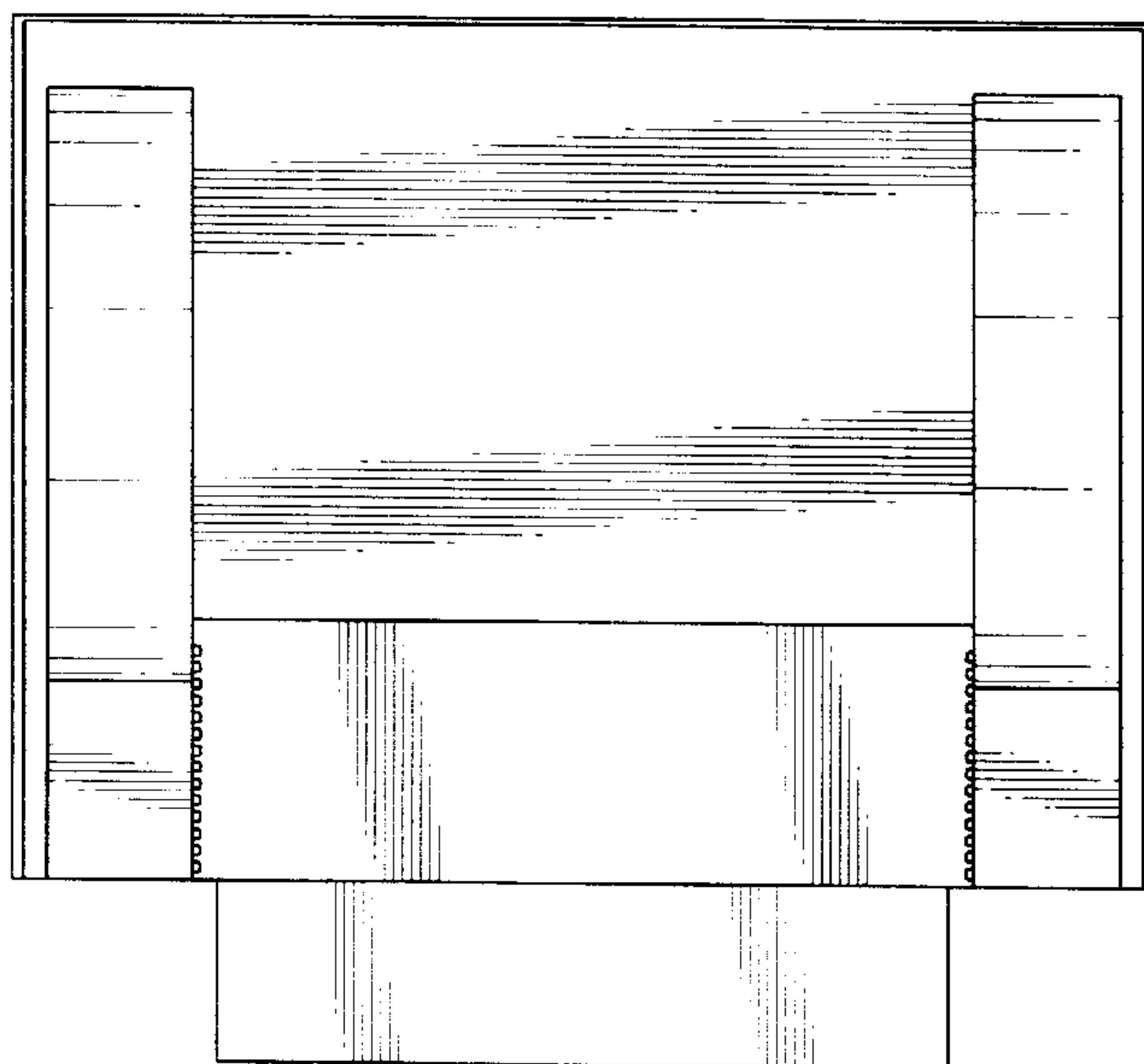

FIG. 3

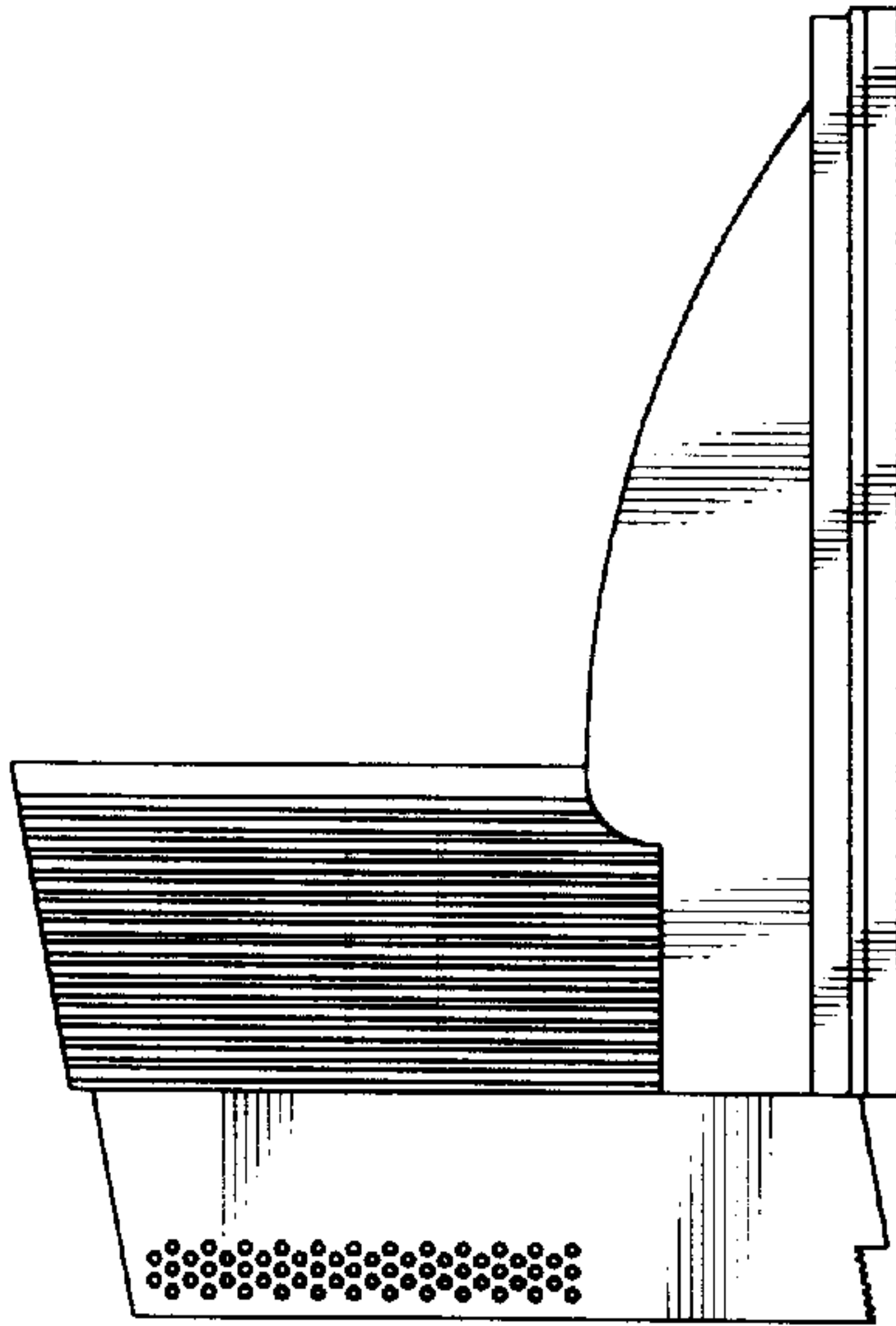

FIG. 4

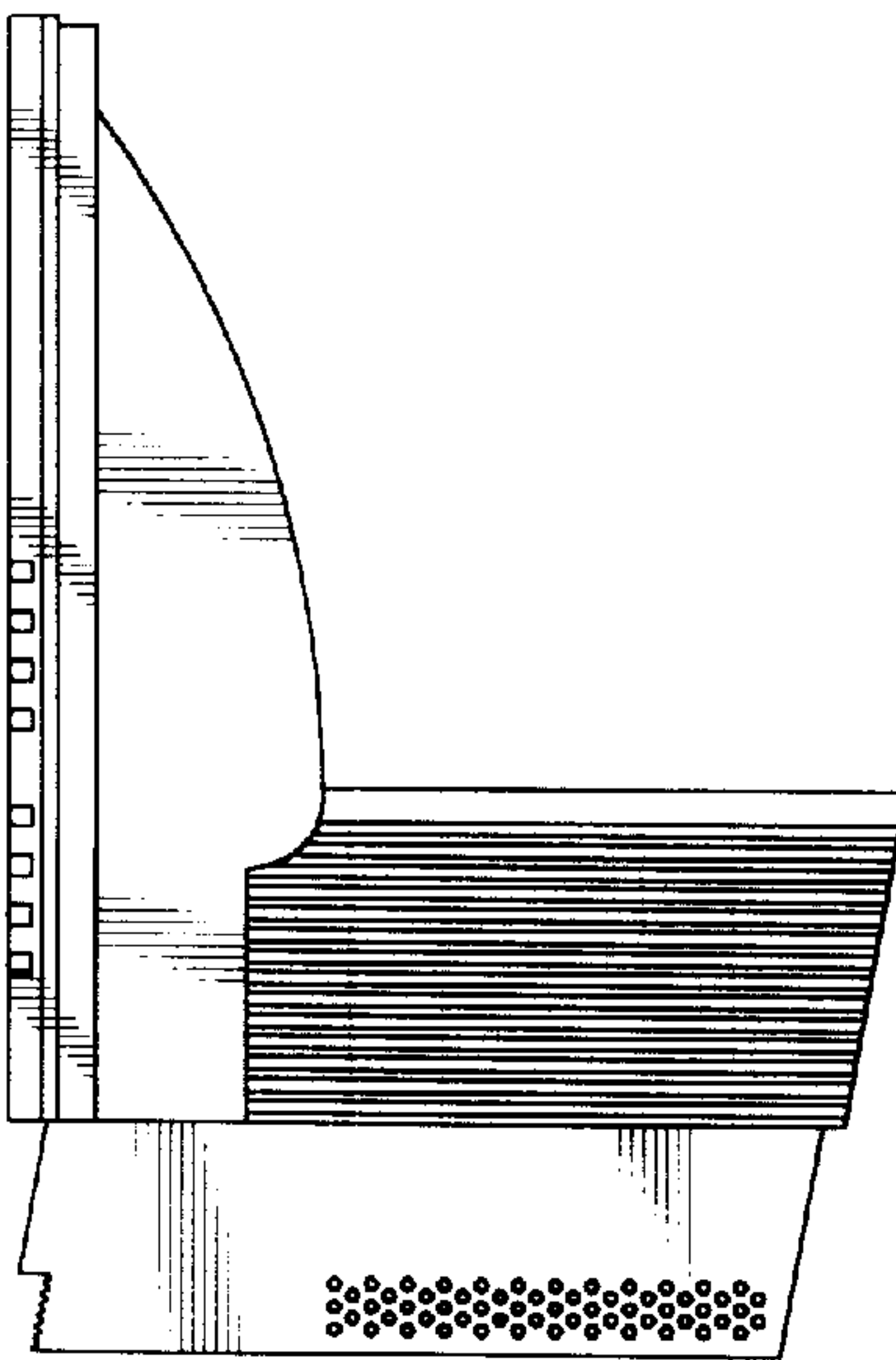

FIG. 5

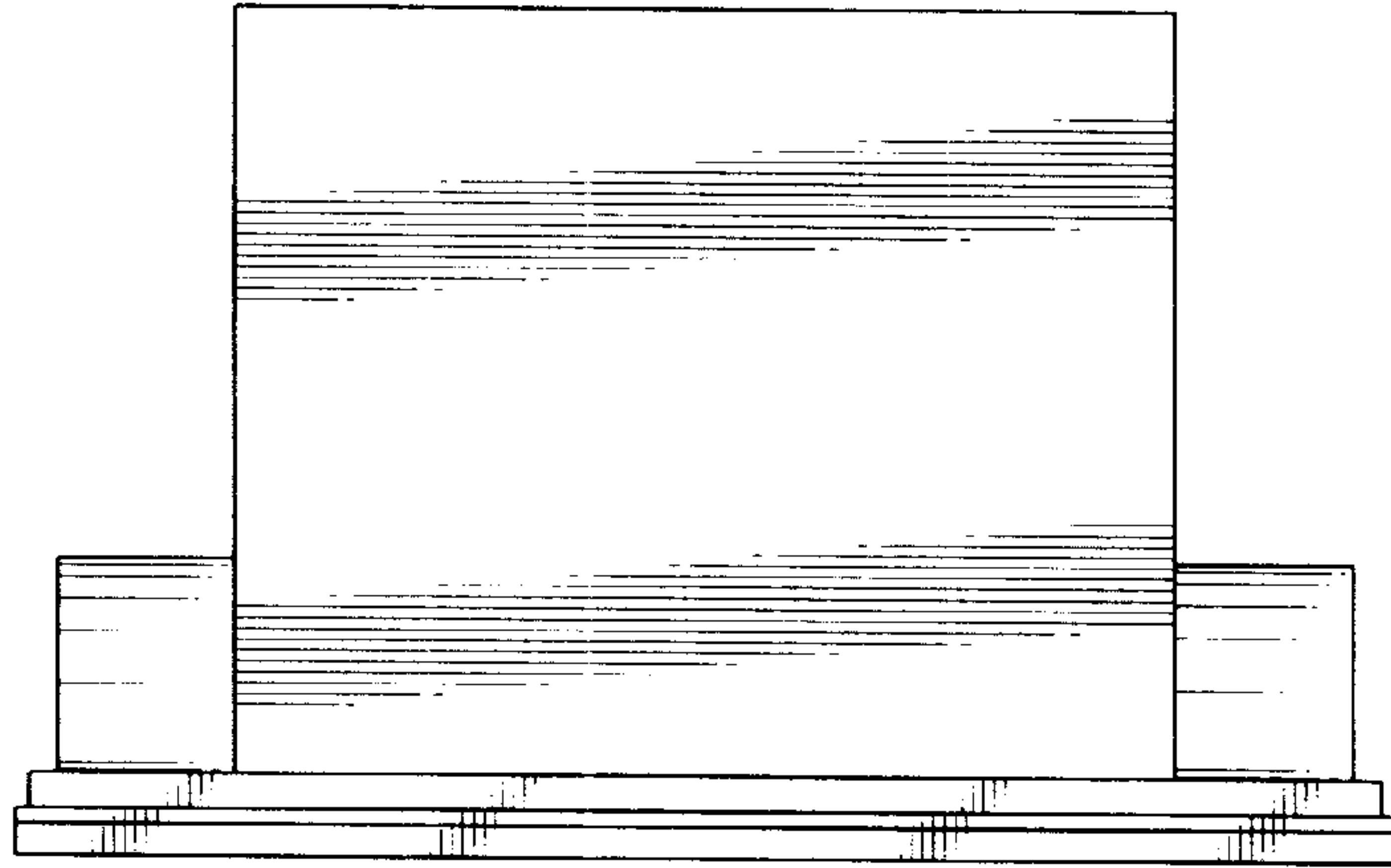

FIG. 6

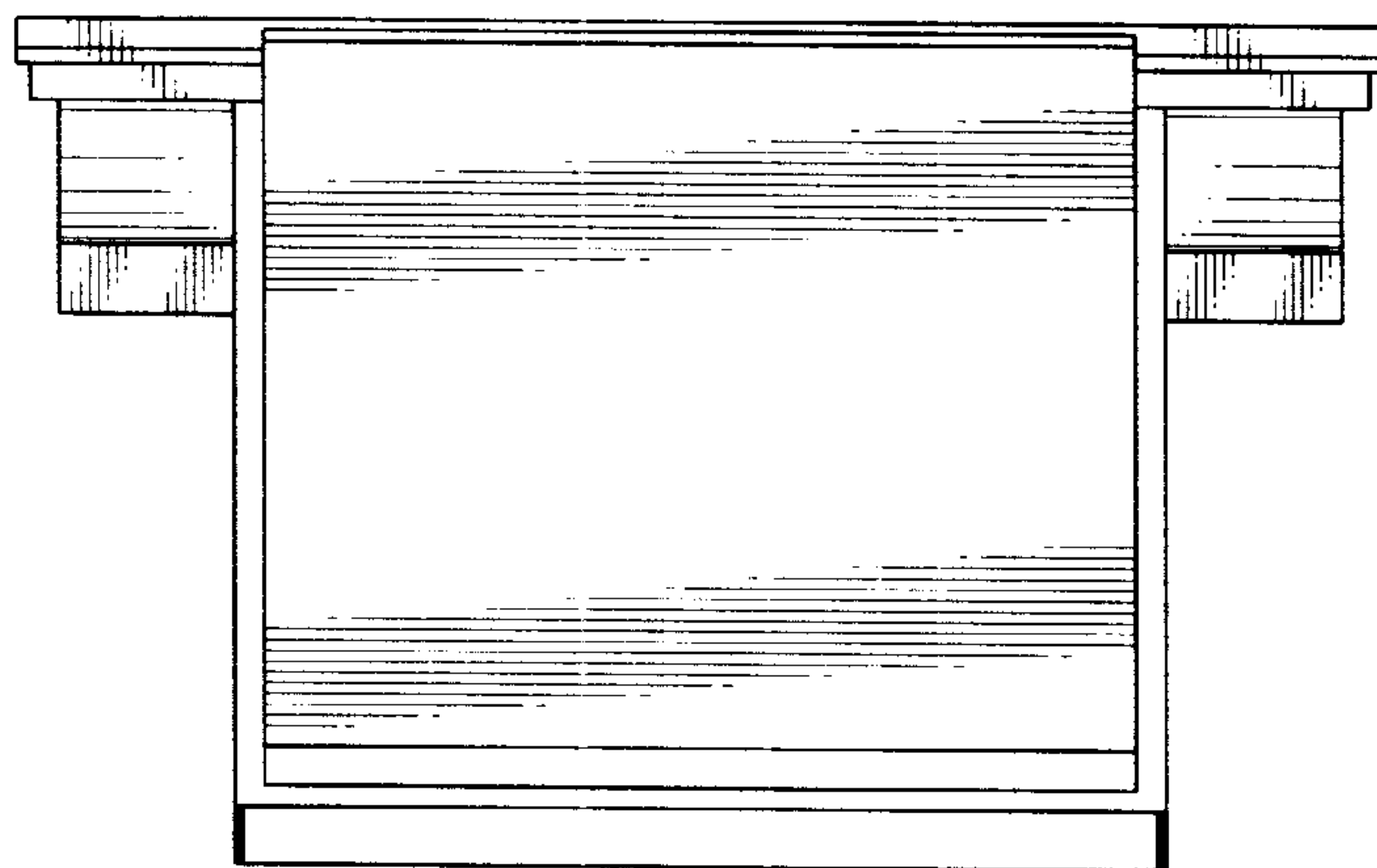

FIG. 7

