



US00D448352B1

(12) **United States Design Patent**
Atsushi

(10) **Patent No.:** **US D448,352 S**

(45) **Date of Patent:** **** Sep. 25, 2001**

(54) **PORTION OF A FREQUENCY CHANGER**

6,133,939 * 10/2000 Gresko et al. 439/579 X

(75) Inventor: **Sato Atsushi**, Ibaraki (JP)

FOREIGN PATENT DOCUMENTS

(73) Assignee: **Kabushiki Kaisha Toshiba**, Kawasaki (JP)

924629 5/1995 (JP) .
1006918 4/1998 (JP) .

OTHER PUBLICATIONS

(*) Notice: This patent is subject to a terminal disclaimer.

9600 USY, Nihon Alcatel Kabushiki Kaisha, (Prior to Oct. 19, 1999).

(**) Term: **14 Years**

* cited by examiner

(21) Appl. No.: **29/121,912**

Primary Examiner—Brian N. Vinson

(22) Filed: **Apr. 18, 2000**

(74) *Attorney, Agent, or Firm*—Banner & Witcoff, Ltd.

(30) **Foreign Application Priority Data**

Oct. 19, 1999 (JP) 11-28661

(51) **LOC (7) Cl.** **13-03**

(52) **U.S. Cl.** **D13/177; D13/156; D13/152**

(58) **Field of Search** D13/177, 158, D13/162, 184, 123, 133, 146, 147, 156, 152; 361/686; 307/147, 115, 116, 125; 439/578, 579, 639; 333/100, 101, 105

(57) **CLAIM**

The ornamental design for a portion of a frequency changer, as shown and described.

DESCRIPTION

FIG. 1 is a top, front and right side perspective view of a portion of a frequency changer showing my new design, FIG. 2 is a front elevational view thereof, FIG. 3 is a top plan view thereof, FIG. 4 is a bottom plan view thereof, FIG. 5 is a left side elevational view thereof, FIG. 6 is a right side elevational view thereof; and, FIG. 7 is a reference view showing the article in use thereof. The broken line showing of the remainder of the frequency changer is for illustrative purposes only and forms no part of the claimed design. Also, the broken line showing of reference environment in FIG. 7 is for illustrative purposes only and forms no part of the claimed design.

(56) **References Cited**

U.S. PATENT DOCUMENTS

- D. 358,753 * 5/1995 Yoshida et al. D13/123
- D. 400,506 * 11/1998 Mahoney D13/146
- D. 400,512 * 11/1998 Korhonen D13/184
- D. 401,568 * 11/1998 Alden et al. D13/184
- D. 416,232 * 11/1999 Einck D13/152
- D. 421,598 * 3/2000 Berusha et al. D13/184
- 5,677,578 10/1997 Tang .
- 5,814,905 9/1998 Tang .

1 Claim, 3 Drawing Sheets

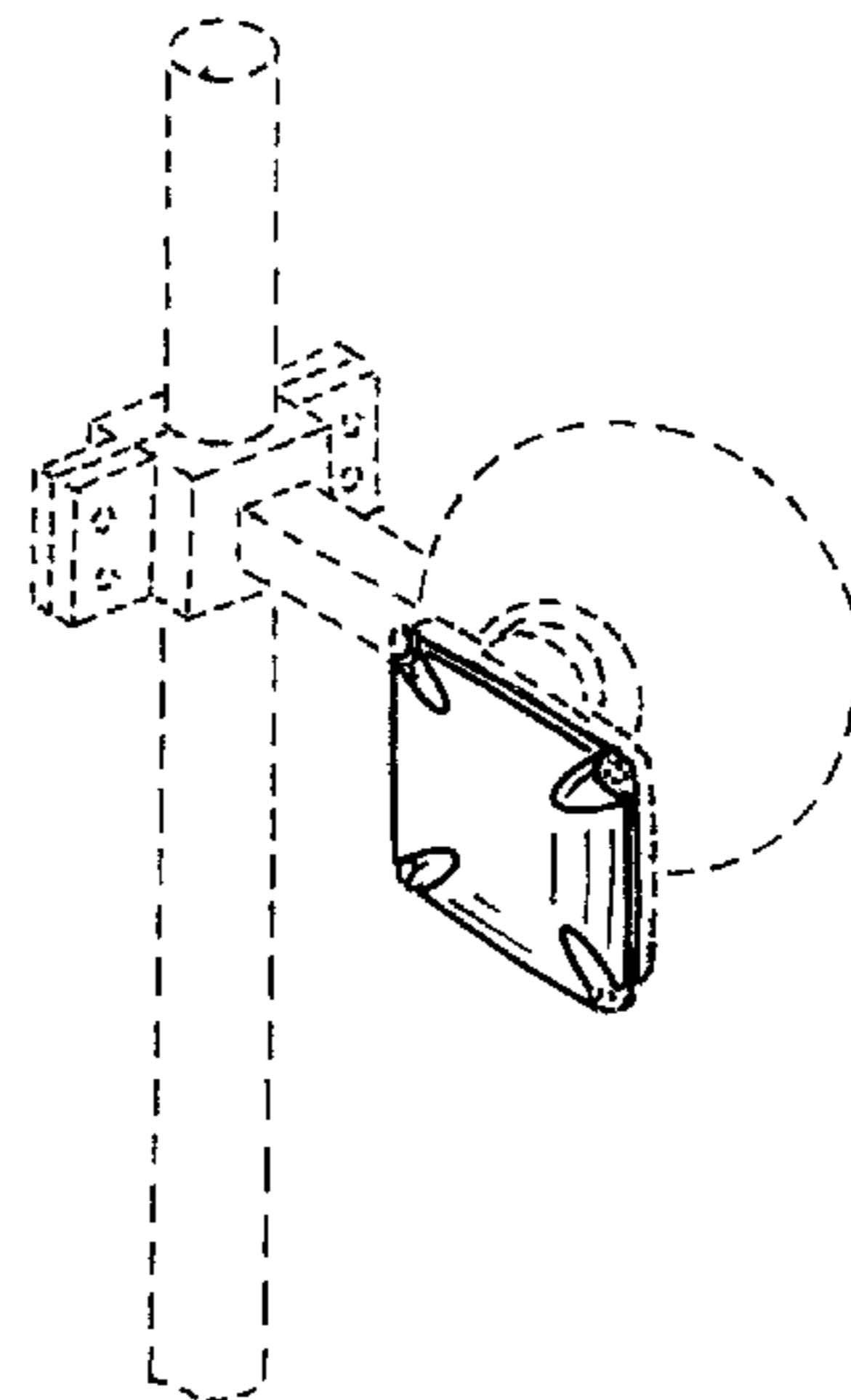
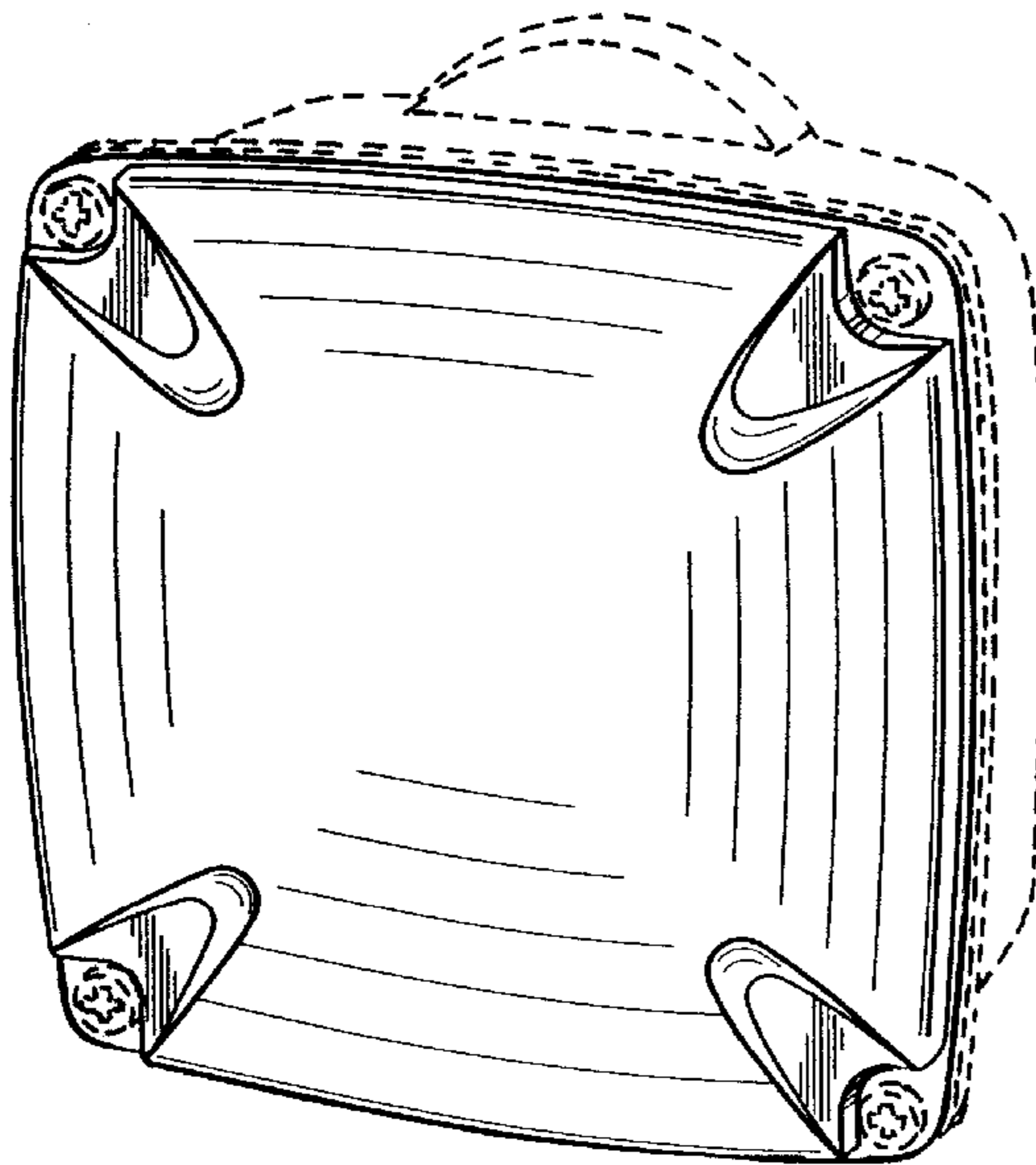

FIG. 1

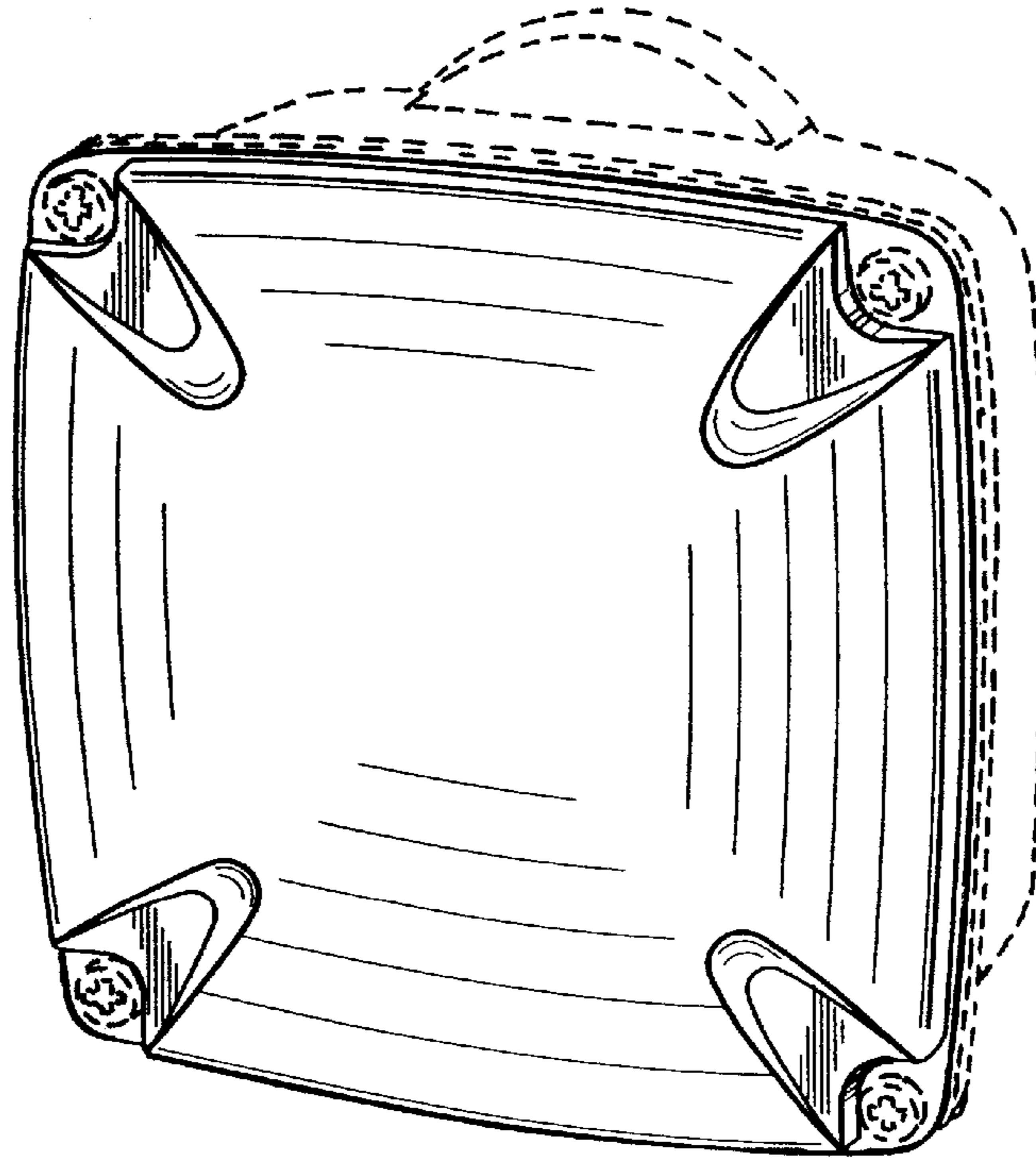

FIG. 2

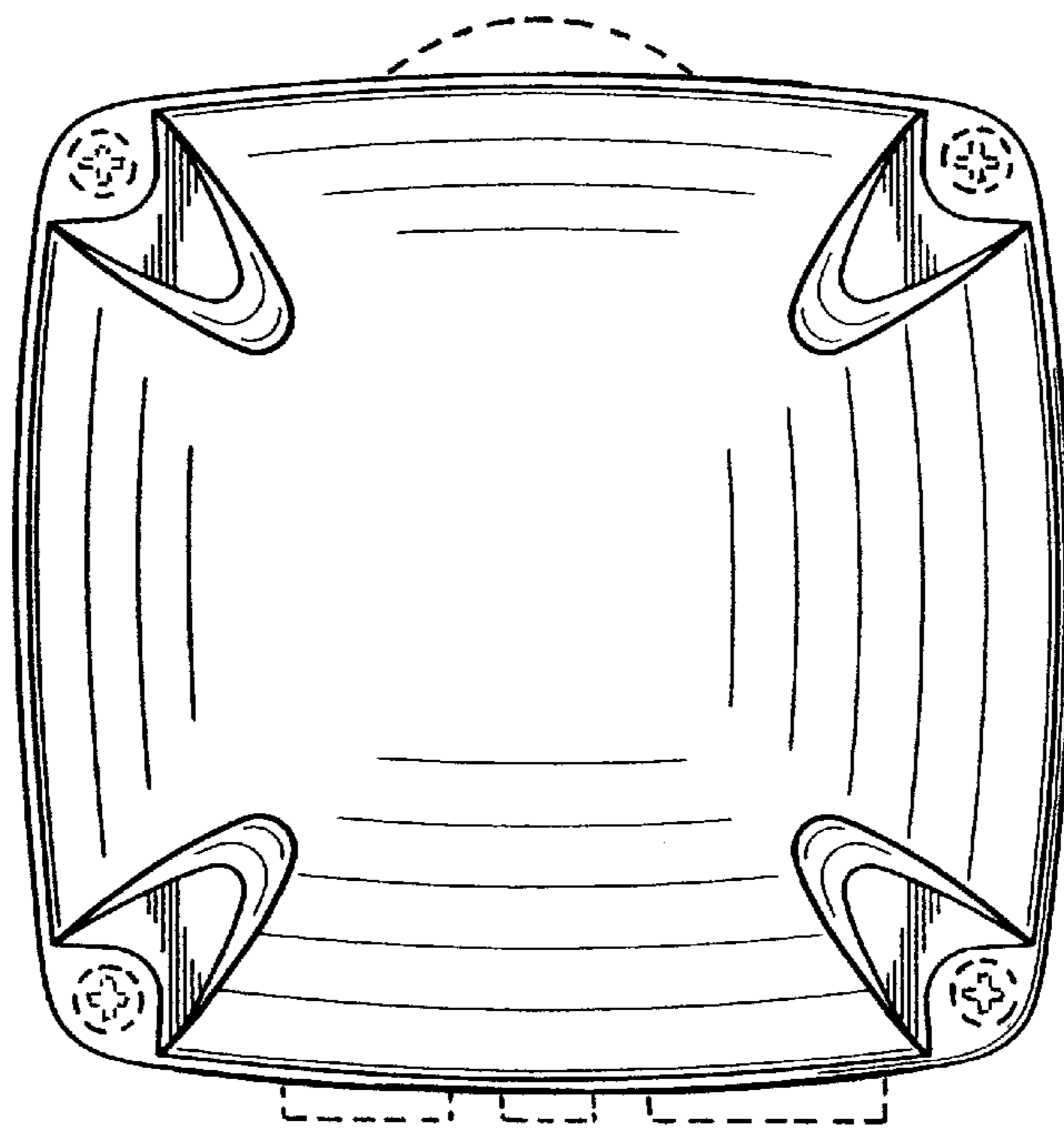

FIG. 3

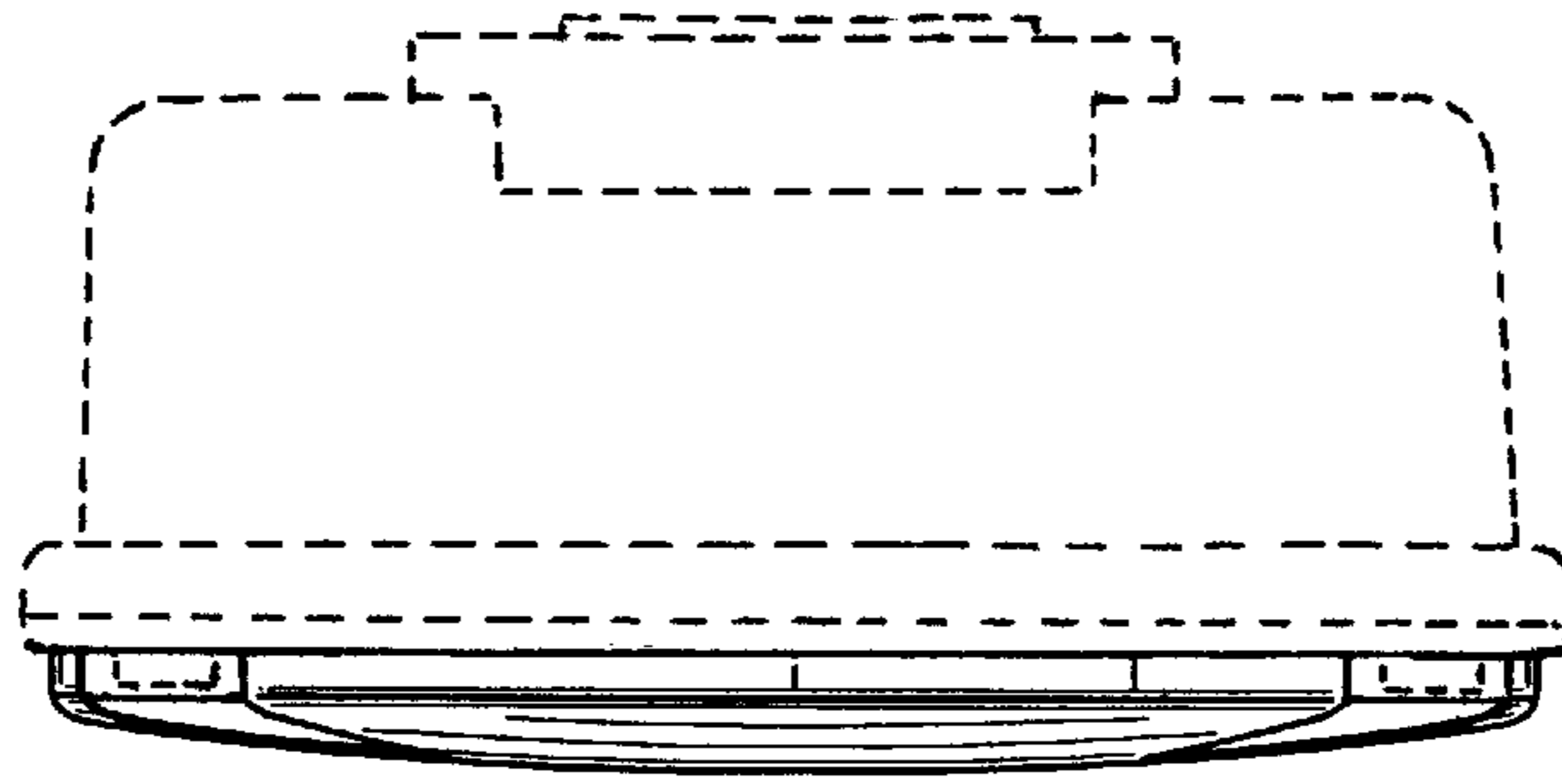

FIG. 4

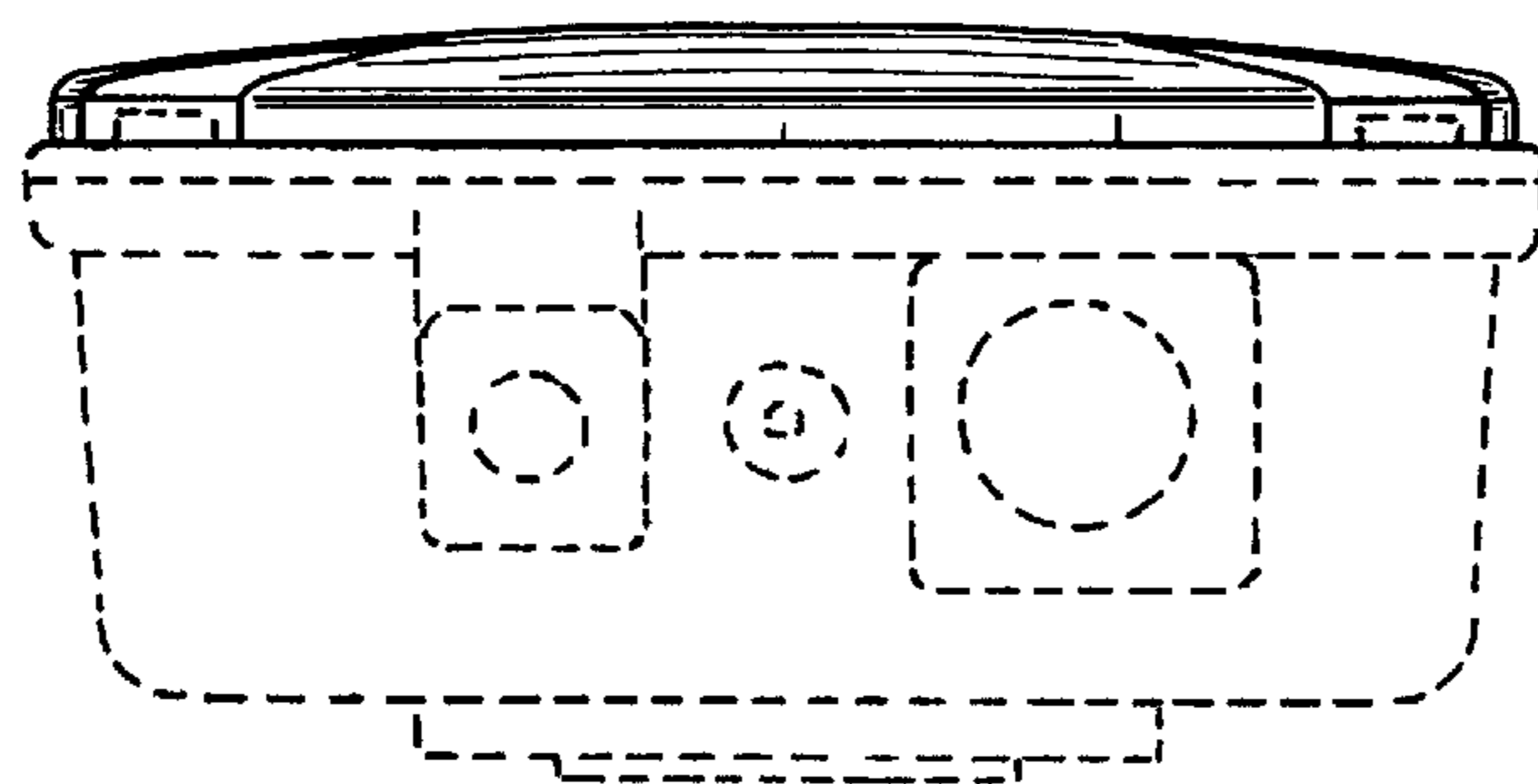

FIG. 5

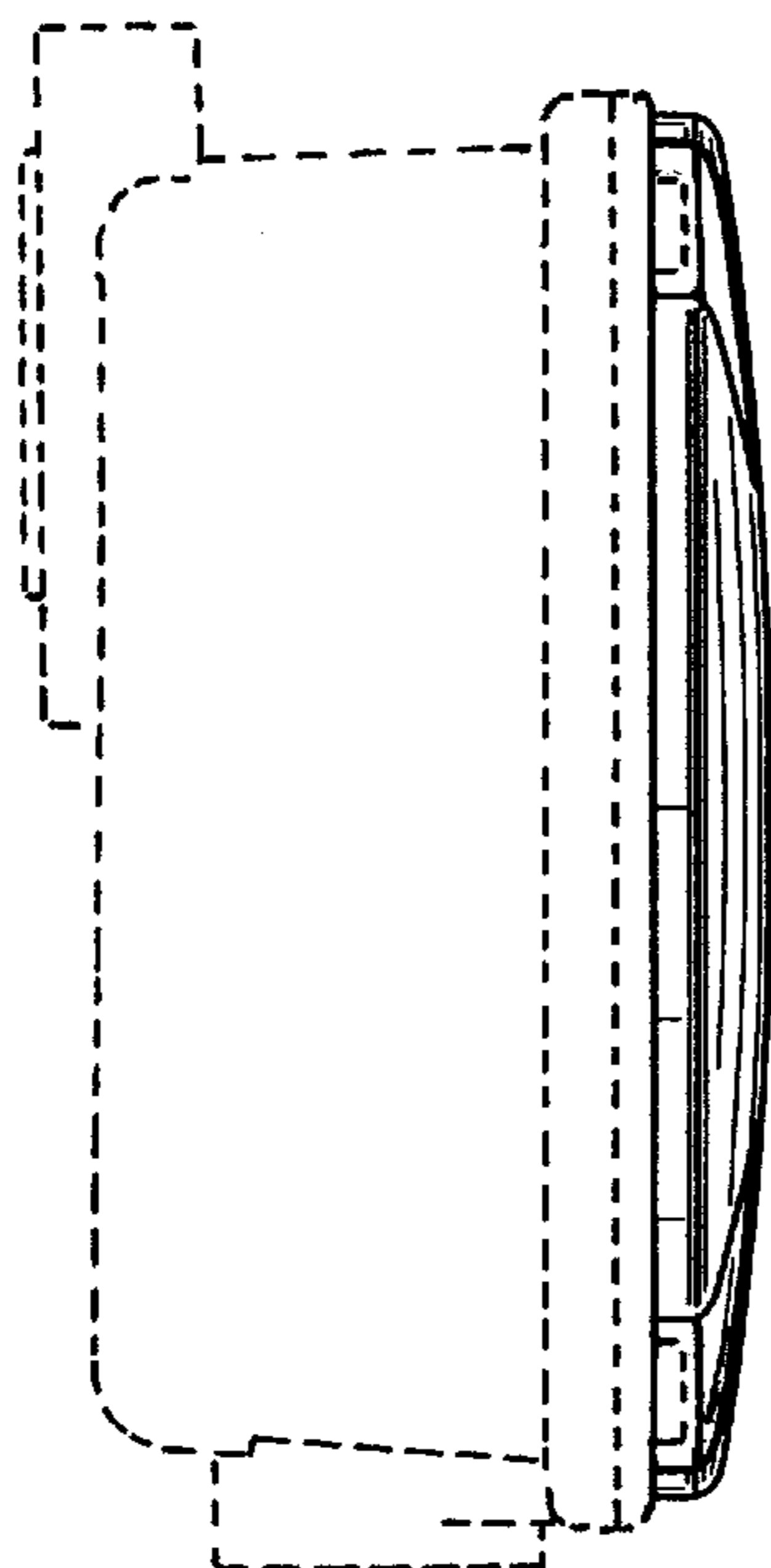

FIG. 6

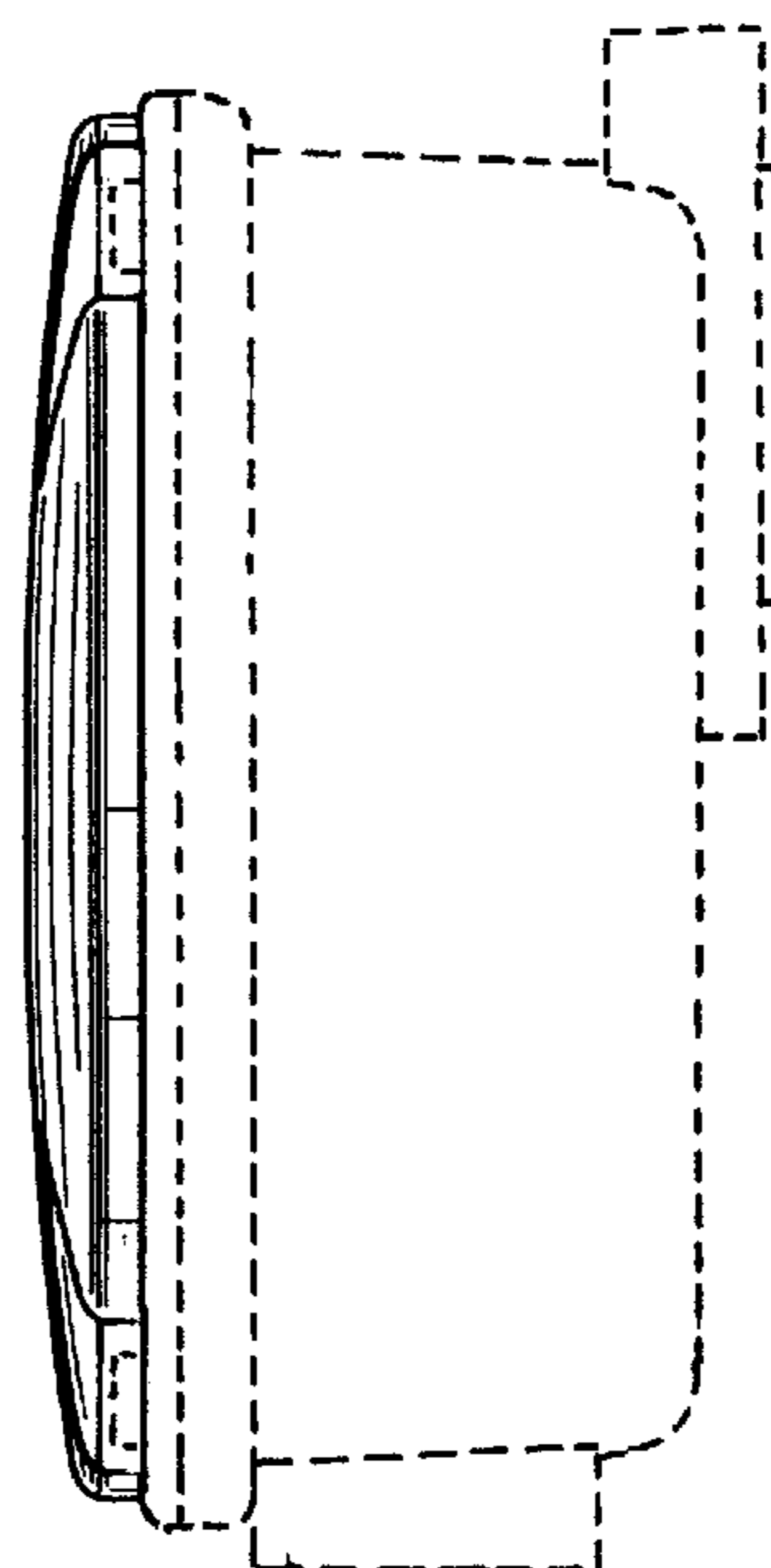

FIG. 7

