



US00D448289B1

(12) **United States Design Patent**  
Yuen et al.

(10) **Patent No.:** **US D448,289 S**

(45) **Date of Patent:** **\*\* Sep. 25, 2001**

(54) **PACKAGING CAPSULE**

(75) Inventors: **Kaye Kit-Han Yuen**, Alhambra, CA (US); **Oliver Murphy, III**, Austin, TX (US); **Richard C. Schoenert**, Altoona, WI (US); **Paul Anthony Piloni**, Minnetonka, MN (US)

(73) Assignee: **Ecolab Inc.**, St. Paul, MN (US)

(\*\*) Term: **14 Years**

(21) Appl. No.: **29/126,862**

(22) Filed: **Jul. 25, 2000**

(51) **LOC (7) Cl.** ..... **09-03**

(52) **U.S. Cl.** ..... **D9/428; D9/550**

(58) **Field of Search** ..... D9/428, 429, 500, D9/503, 550, 520, 571, 538, 577, 561; 215/378, 382, 384; 270/601, 625; D32/25, 30; 221/312 C

(56) **References Cited**

**U.S. PATENT DOCUMENTS**

- D. 25,097 \* 1/1896 Macarthy ..... D9/503
- D. 95,620 \* 5/1935 Smith ..... D9/550
- D. 288,293 2/1987 Arvans .
- D. 393,421 \* 4/1998 Kovens ..... D9/428

- D. 433,946 \* 11/2000 Rollend et al. .... D9/538
- D. 441,998 \* 5/2001 Kauzlarich et al. .... D9/520
- 3,325,031 \* 6/1967 Singier ..... 215/382
- 3,581,928 \* 6/1971 Amaad ..... 215/375
- 3,923,178 \* 12/1975 Welkwr, III ..... 215/382
- 4,054,219 \* 10/1977 Young et al. .... 215/375

\* cited by examiner

*Primary Examiner*—Prabhakar Deshmukh

(74) *Attorney, Agent, or Firm*—Merchant & Gould P.C.

(57) **CLAIM**

The ornamental design for packaging capsule, as shown and described.

**DESCRIPTION**

FIG. 1 is a perspective view of the top, front, left view of the packaging capsule of present invention;  
 FIG. 2 is a front view of the packaging capsule of FIG. 1;  
 FIG. 3 is a back view of the packaging capsule of FIG. 1;  
 FIG. 4 is a right view of the packaging capsule of FIG. 1;  
 FIG. 5 is a left view of the packaging capsule of FIG. 1;  
 FIG. 6 is a bottom view of the packaging capsule of FIG. 1;  
 and,  
 FIG. 7 is a top view of the packaging capsule of FIG. 1.  
 The broken lines are for illustrative purpose only and forms no part of the claimed design.

**1 Claim, 4 Drawing Sheets**

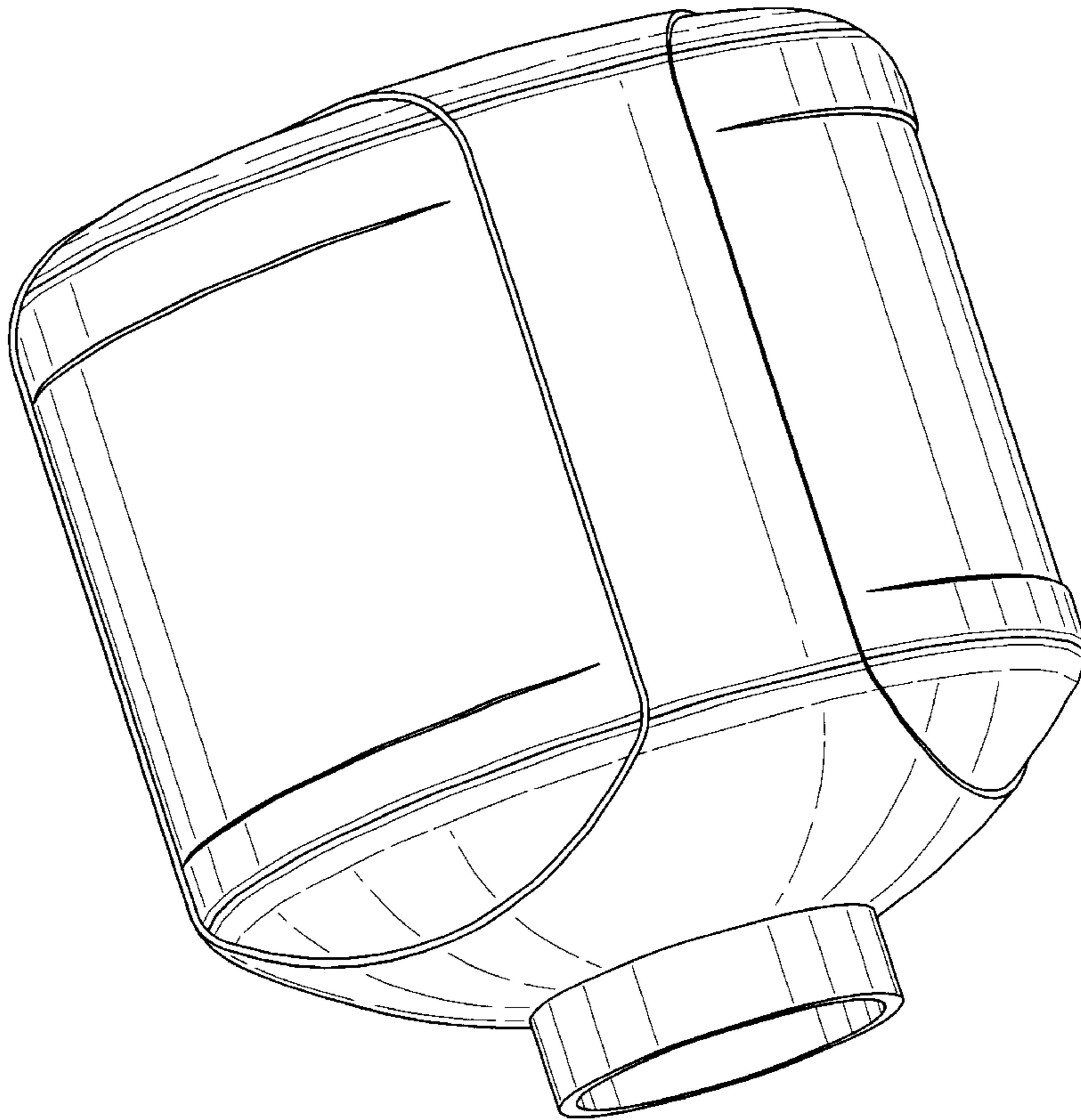

FIG. 1

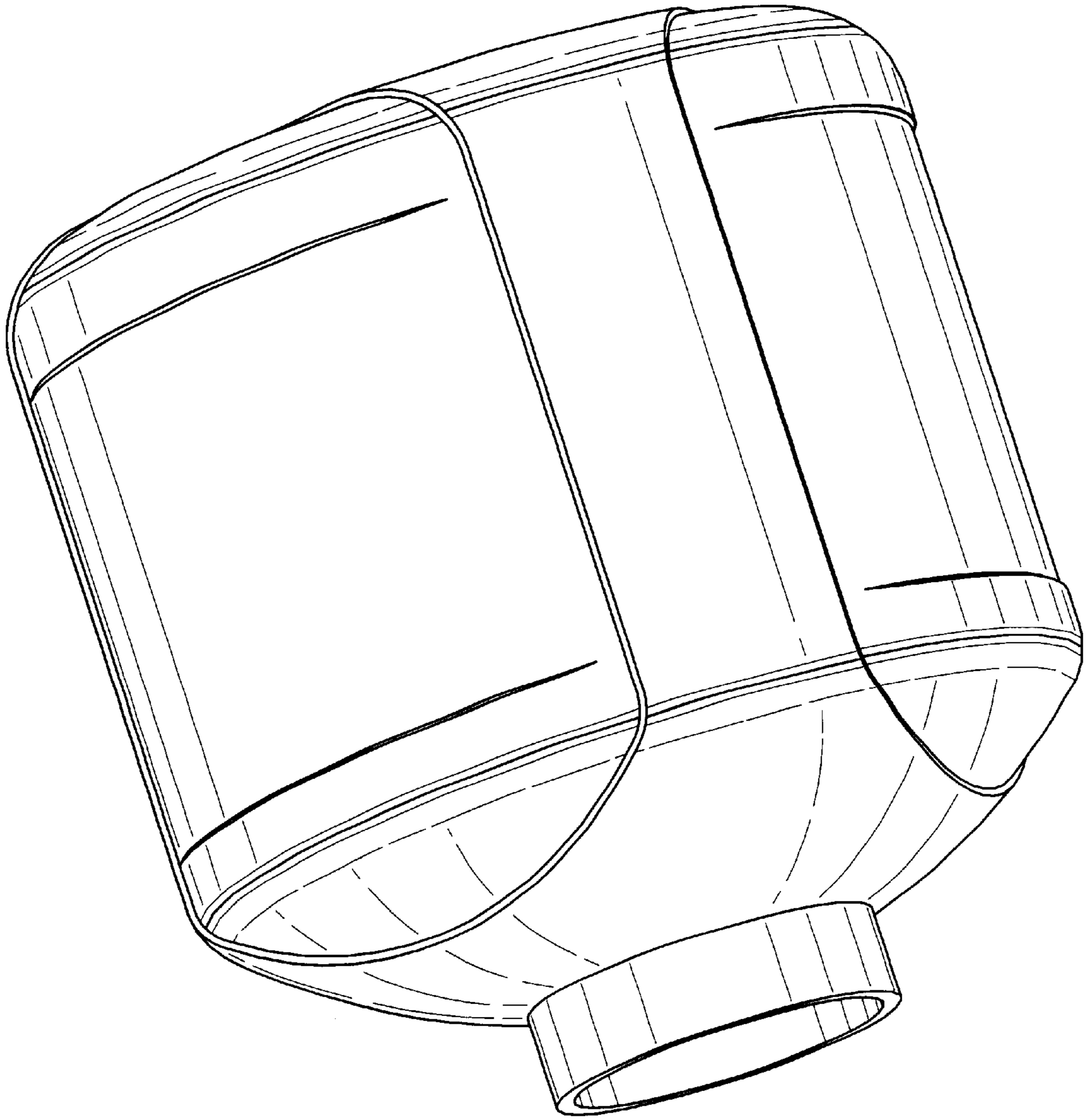

FIG. 2

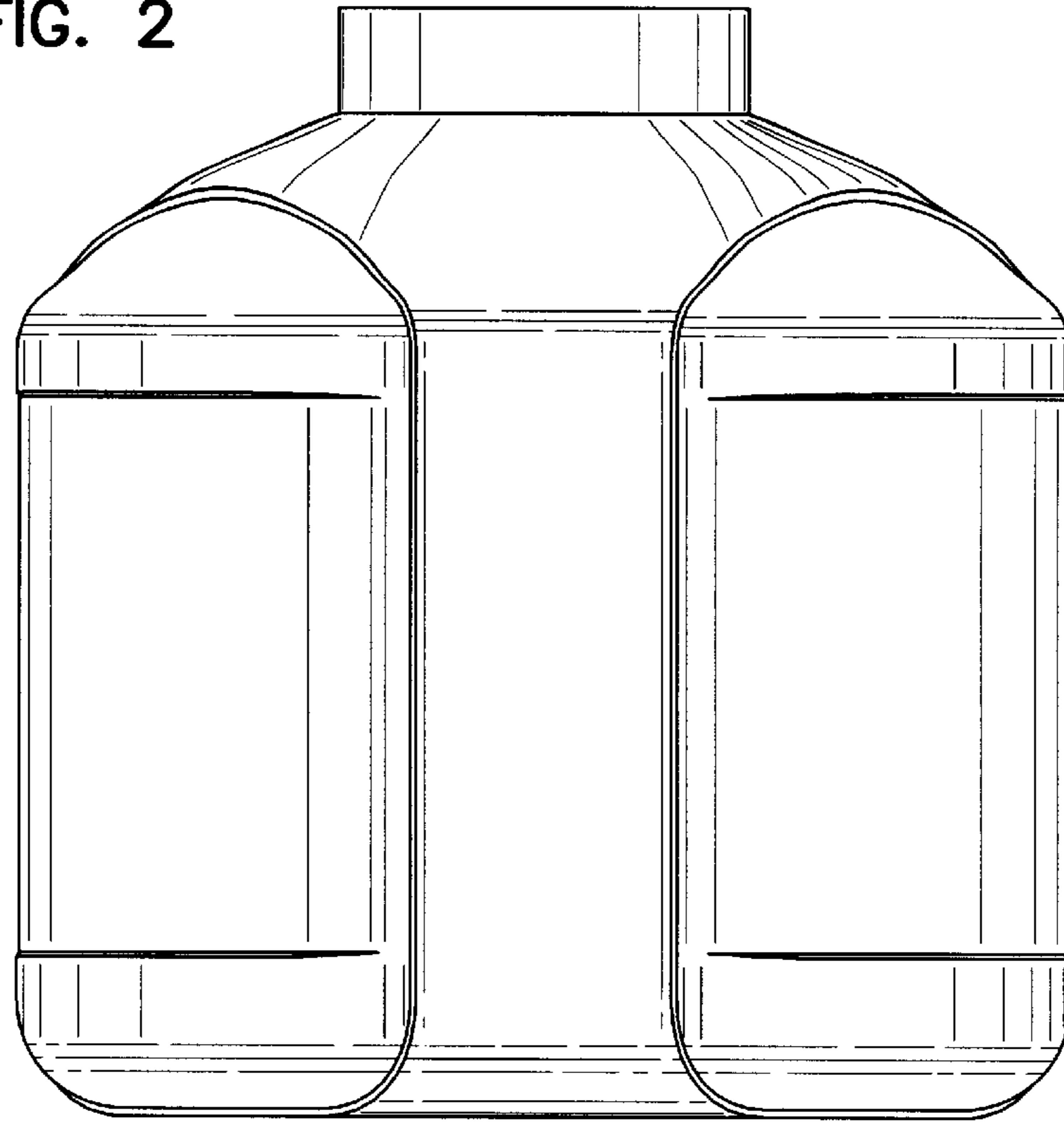

FIG. 3

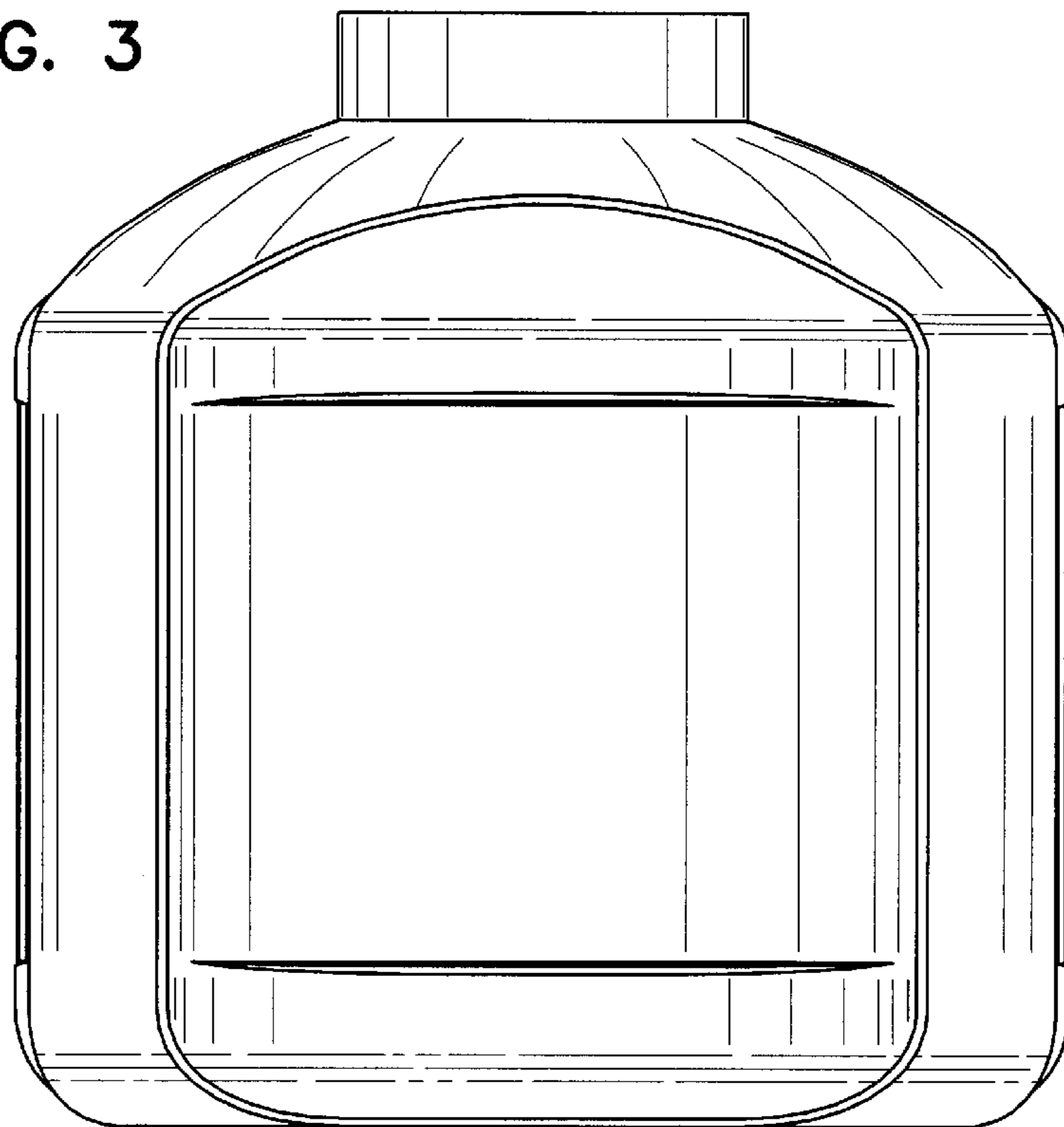

FIG. 4

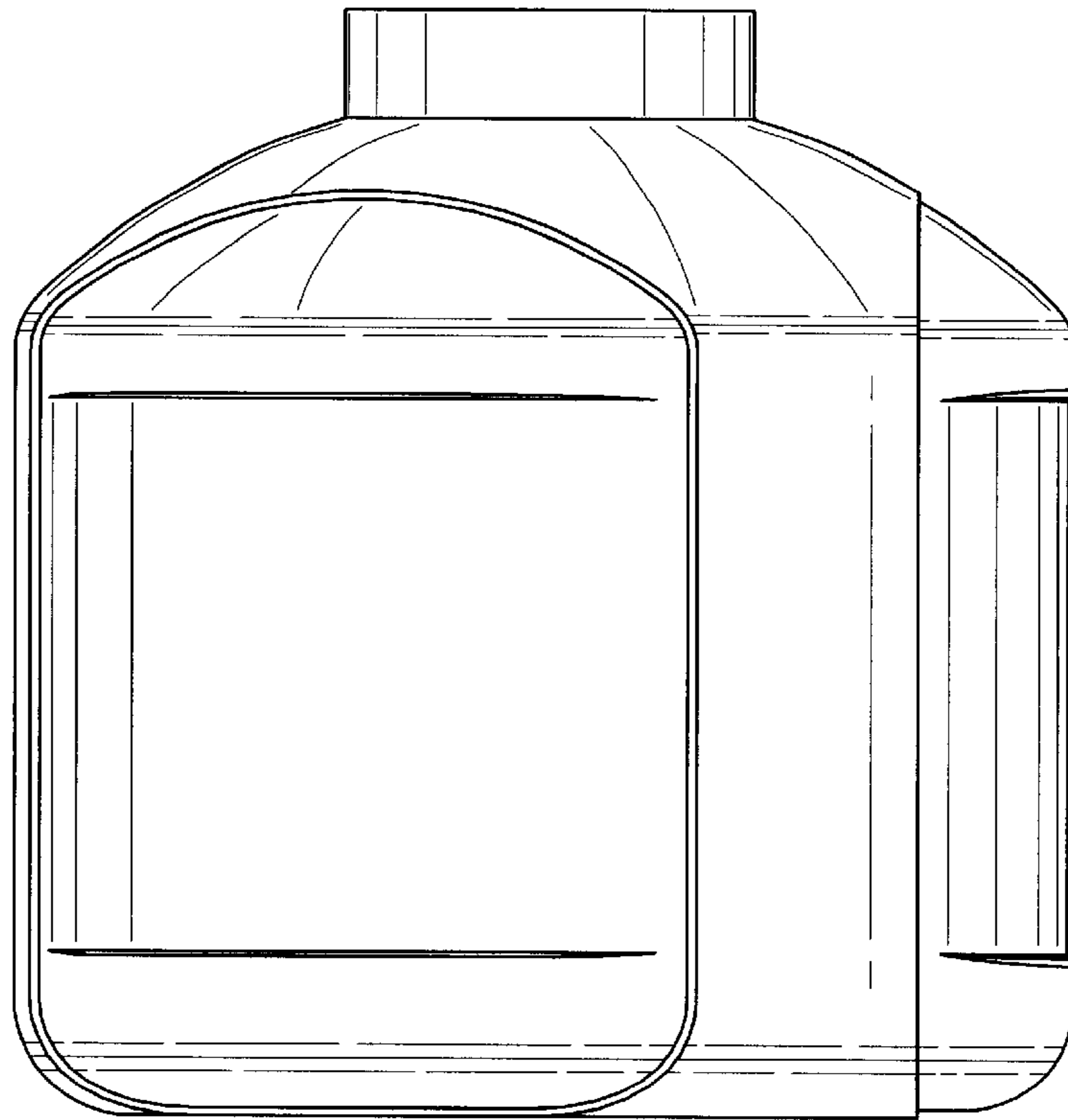

FIG. 5

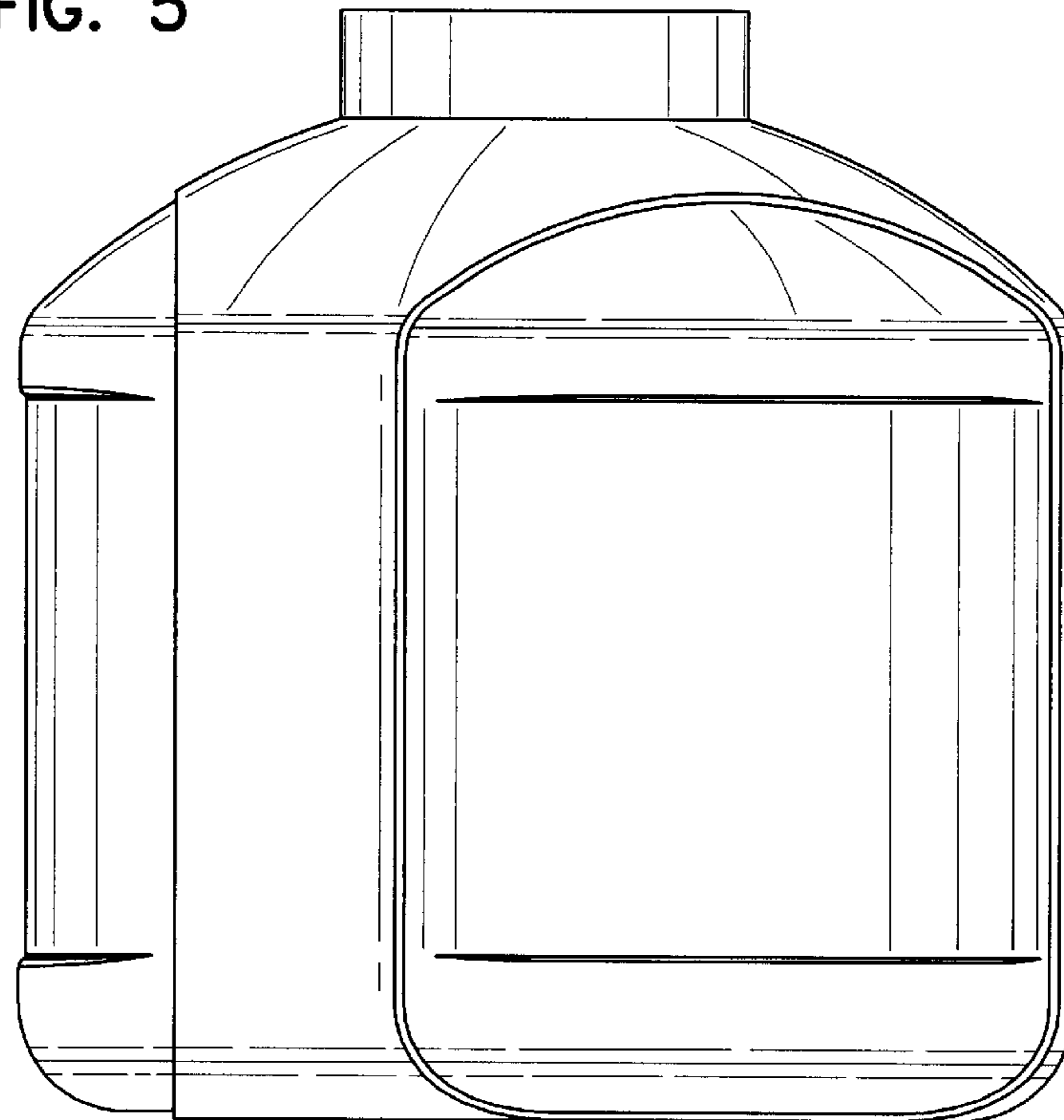

FIG. 6

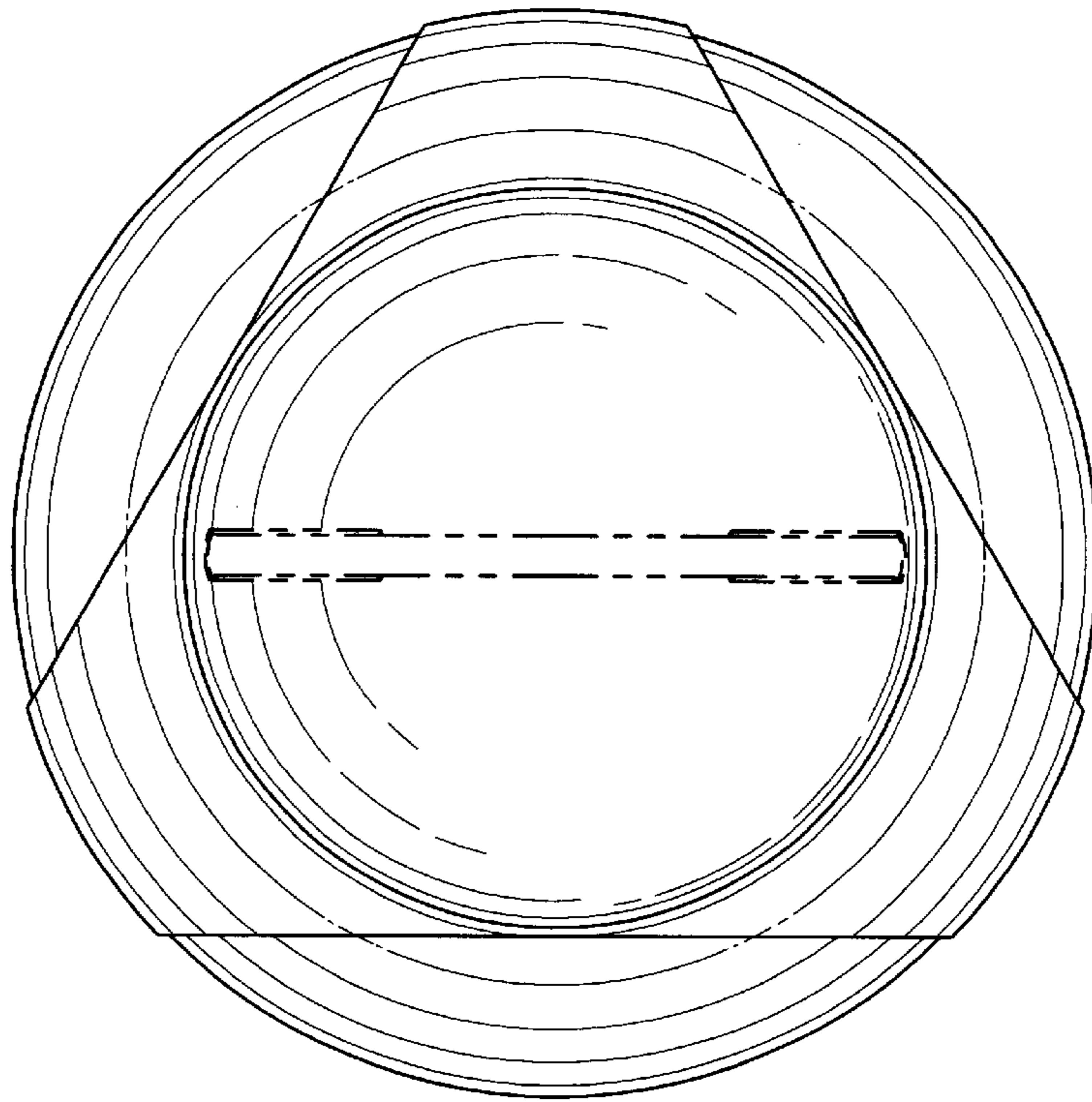

FIG. 7

